

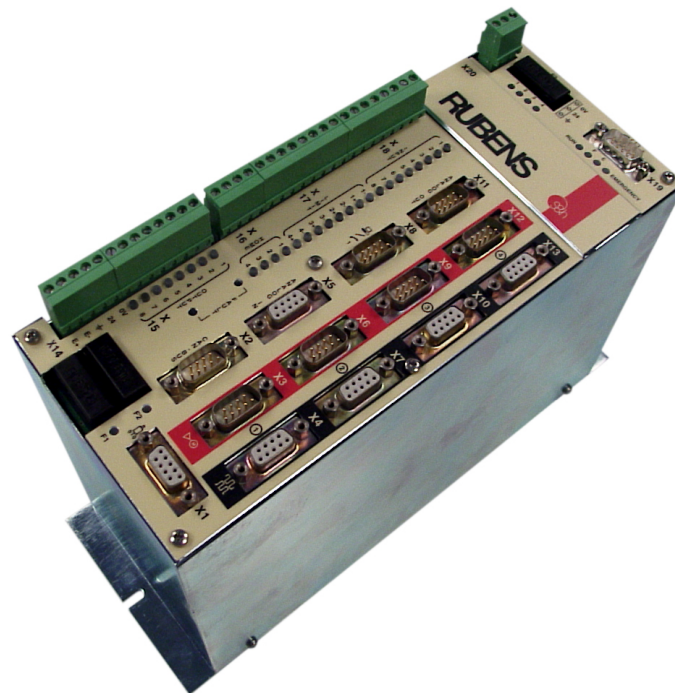

RUBENS

STD 1 USER'S MANUAL



MANUAL VERSION : 1.03

<i>Refers to software version::</i>	RUBENS 1.00
	CNC / PLC: 3.00 / 3.00

MANUAL CODE: MA RUB U STD1 13

DATE: 20 LUGLIO 2000

This documentation has been produced by S&h for the exclusive use of purchasers of the Rubens manufactured by the same S&h.
Its contents are the property of S&h and may not be reproduced in whole or in part without the written consent of S&h.
The information contained in the present documentation is subject to change without prior notice and does not constitute a commitment on the part of S&h.

© *Copyright 1998 S&h. All rights reserved*

Index

GENERAL	5
INTRODUCTION	5
VERSION	5
FIRMWARE GENERAL STRUCTURE	6
OPERATION MODE	7
COMMUNICATION	8
CUSTOMISING THE SYSTEM	8
INSTALLATION AND CONNECTIONS	9
UNPACKING	9
CHECKING THE BOARD	9
PRELIMINARY CONFIGURATION	10
CONFIGURATION OF THE PC.....	10
COMMUNICATION SOFTWARE	10
BACH SOFTWARE INSTALLATION AND CONFIGURATION.....	10
CONNECTION EXAMPLE	11
TECHNICAL DATA	13
DIMENSIONS	13
RUBENS PANEL	14
CONNECTORS ON THE RUBENS PANEL	15
TERMINALS ON THE RUBENS PANEL	17
SERIAL PORT CONNECTIONS	18
CONNECTOR: X8, X19	18
ENCODER CONNECTIONS	19
CONNECTOR: X4, X7, X10, X13	19
ENCODER SUPPLY.....	20
DRIVE CONNECTIONS (ANALOGUE)	21
CONNECTORS: X3, X6, X9, X12	21
DRIVER CONNECTIONS (FREQUENCY)	22
CONNECTORS: X3, X6, X9, X12.....	22
DIGITAL INPUT CONNECTIONS	23
TERMINALS: X18, X17, X16, X14	23
RUBENS IMAGE OF INPUTS 31...0	24
DIGITAL OUTPUT CONNECTIONS	25
TERMINALS: X15	25
RUBENS IMAGE OF THE OUTPUTS 31...0	26
ANALOGUE INPUT CONNECTIONS	27
CONNECTOR: X5	27
ANALOGUE OUTPUT CONNECTIONS	28
CONNECTOR: X11	28
CONNECTION OF THE PROXIMITY SWITCH	29
CAN-BUS CONNECTION	30
INSTALLATION RECOMMENDATIONS	30

RUBENS- USER'S MANUAL

GENERAL

INTRODUCTION

The present manual contains all information regarding the technical characteristics and the performance of the CNC on the Rubens board. It is designed as a useful guide which can be referred to for a quick understanding and for efficient application of all its functions.

The Rubens CNC is a NUMERICAL CONTROLLER packaged in a metal case for rear-of-panel mounting. It is designed to control up to 4 axes that can be STEPPER, DC or BRUSHLESS motors both in point to point positioning and in linear or circular interpolation. It can handle the machine I/O (16 inputs and 8 outputs) both in sequential mode and as a PLC program (optional). The I/O can be expanded up to 128 inputs and 128 outputs via Can-Bus.

Main features:

- Power supplies: +24Vdc
- Maintains data and programs even in the event of a power out.
- 1...4 axes STEPPER, DC OR BRUSHLESS
- PID control algorithm and programmable feedforward action.
- Point to point positioning, linear interpolation, circular interpolation
- Programmable velocity profiles
- Encoder feedback, even for stepper motors
- 16 in and 8 out that can be handled sequentially or in PLC logic (optional), expandable to 128+128 using industrial Can-Bus.
- Programming language: ISO (extended) for the axes control section, AWL (in the PC) for the PLC section.
- Fast input for acquisition of the axes co-ordinates (touch probe)
- Auxiliary analogue inputs (max. 8)
- Handling the program "Variables"
- Serial port (definable as RS232/422/485) for connecting the machine control panel "MCP".
- 4 incremental encoders
- Parallel process control
- Interface for DC or BRUSHLESS motor drives: REF ($\pm 10V$ / 16bit), DIR, ENABLE, FAULT
- Interface for STEPPER motor drives: PULSE(800KHZ), DIR, ENABLE, FAULT

VERSION

The information in this manual refers to the "Rubens Software Version " shown on the cover.

The message showing the software version installed in the Rubens can be read using the %99 instruction.

FIRMWARE GENERAL STRUCTURE

The Rubens has an operating system inside that performs the control of several processes in parallel; in particular the following tasks are executed:

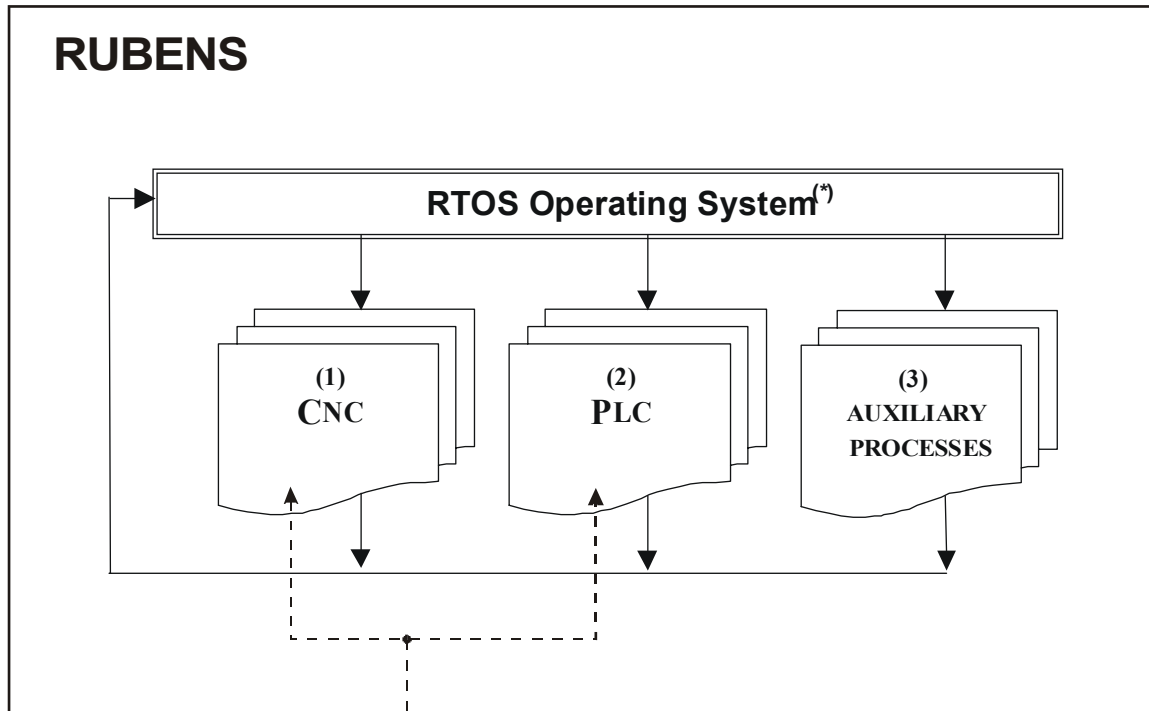

CNC

This is the task for the control of the axes

PLC

This task handles the machine I/O (as PLC section)

AUXILIARY PROCESSES

Performs the service tasks: communication, error handling, timing, alarms, watchdog, etc.

(*): Real Time Operating System

OPERATION MODE

The operation mode of the Rubens controller can be illustrated by the following drawing, in which the components, that are described later, are divided into groups by function.

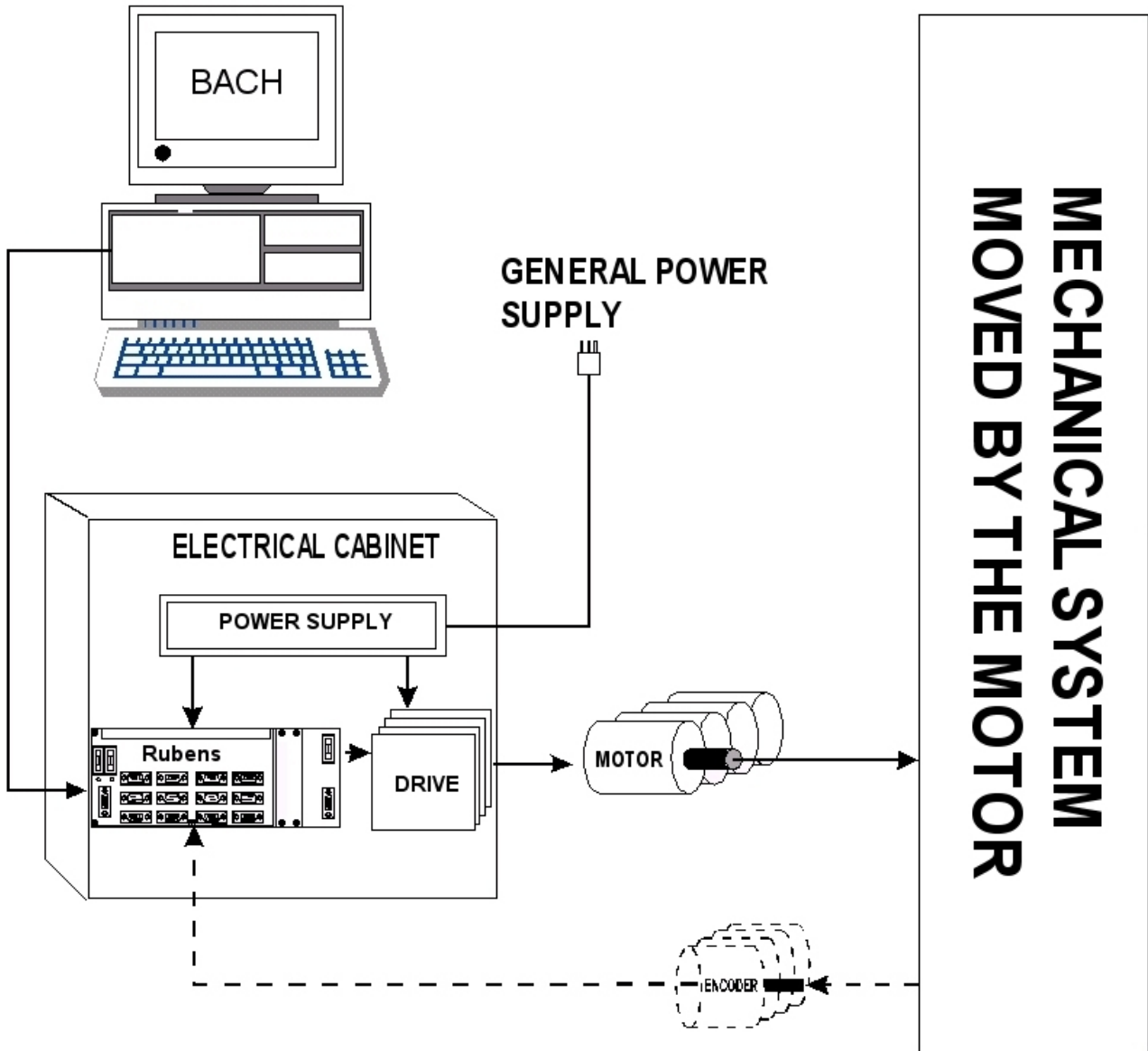

- ◆ *Power supply unit:* the group of components that make up the electronics that are used to supply the correct power to the control unit (and other parts of the system). Usually made up of a transformer and the associated protection and manoeuvring devices that must be provided by the user.
- ◆ *Controller:* electronics of the mechanical displacement system that takes care of, together with other parts of the system, the movement along the axes, the electromechanical actuators and any sensors present on the machine.
- ◆ *Drive Unit:* the electronics of a mechanical displacement system that receives and transmits analogue and digital signals from the external controller and drives the motor in such a way that it performs the movements required by the controller
- ◆ *Motor:* is the component, driven by the drive unit, and coupled with the mechanical parts, physically performs the movements along an axis.

- ◆ *Encoder*: is the electronic component that supplies the position information for the mechanical axis (displacement transducer). It may not be used if the system is designed as "open loop" (e.g. with stepper motors).

COMMUNICATION

The Personal Computer can control the (1)Cnc and (2)Plc processes directly, using the BACH support software that enables the operator to: upload/download programs, setup and calibration of the axis parameters, writing/compilation/debugging of the Plc program etc..

CUSTOMISING THE SYSTEM

The @ commands may be used to customise the system by assigning values that differ from those of the default parameters.

- ◆ For a full description of these commands, refer to the manual supplied with the Picasso 2000 board.

INSTALLATION AND CONNECTIONS

UNPACKING

The Rubens package contains the following components:

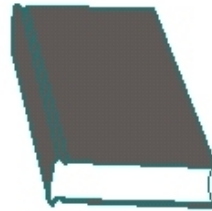
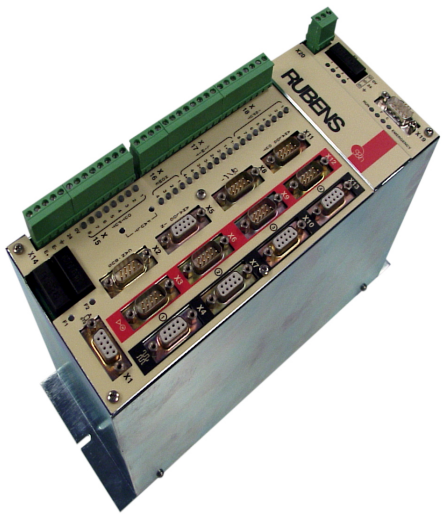

PROGRAMMING
MANUAL

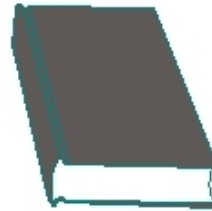

USERS'
MANUAL



INSTALLATION
AND
CONFIGURATION
OF BACH SOFTWARE

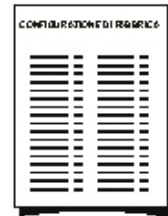

FACTORY
CONFIGURATION
SHEET

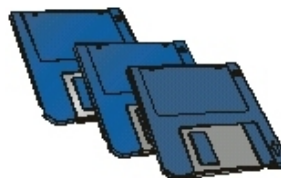

BACH
SOFTWARE
INSTALLATION
DISKETTES

CHECKING THE BOARD

Before installing the Rubens controller, check that there are no obvious anomalies. In spite of all the careful checks performed in the factory, it is possible that they can become damaged during the packing or transport. If this is the case, please contact our factory immediately.

PRELIMINARY CONFIGURATION

CONFIGURATION OF THE PC

Check that the number of the serial port (COM) selected for the communication with the PICASSO2000 board is different from serial ports already present on the PC.

If you wish to install the Picasso2000 board on a serial port that is already occupied on the PC, then it is necessary to deactivate the serial port of the PC in the system BIOS.

COMMUNICATION SOFTWARE

The BACH program is support software created by S&h.
It is designed to be installed on a PC running Windows 95/98 operating system.

BACH SOFTWARE INSTALLATION AND CONFIGURATION

See the instructions provided.

CONNECTION EXAMPLE

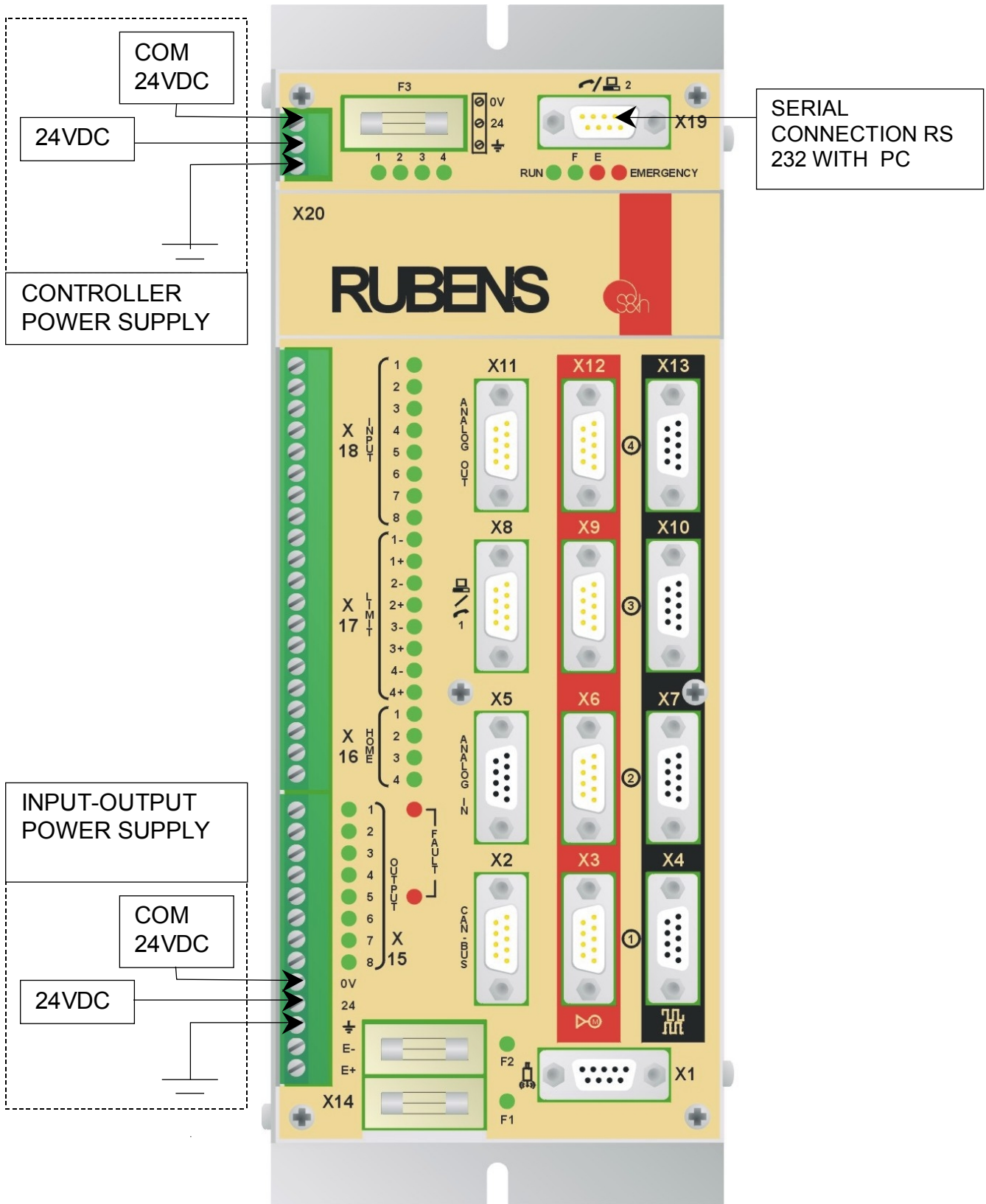

Connect the Rubens controller to the serial port of the PC (COM1 or COM2) using a PC-PC serial cable and configure the port as indicated in the section "Serial link connection".

Power up the controller as indicated in the figure. If the connection is made correctly, the "RUN" indicator on the front of the Rubens will flash for a few seconds and then will become fixed.

At the same time, the "F1" indicator will light up. Although this is not fitted if the encoder has external power supply.

Power up the controller inputs and outputs as shown in the drawing. If the "F2" indicator illuminates, the connection is correct.

Run the BACH program. Click on the connection key. If the connection is not effected automatically, the "Connection" window will appear. Select the Rubens controller and the communication port used. Now it will be possible to communicate with the controller.

TECHNICAL DATA

POWER SUPPLY VOLTAGES	+24VDC
CONSUMPTION	24VDC: 700mA +5VDC ENCODER 400mA
STORAGE TEMPERATURE	0 +50 C°
OPERATING TEMPERATURE	+5 ... +40 C°
RELATIVE HUMIDITY	20% ... 80% (NON-CONDENSING)
WEIGHT	2.8 KG

DIMENSIONS

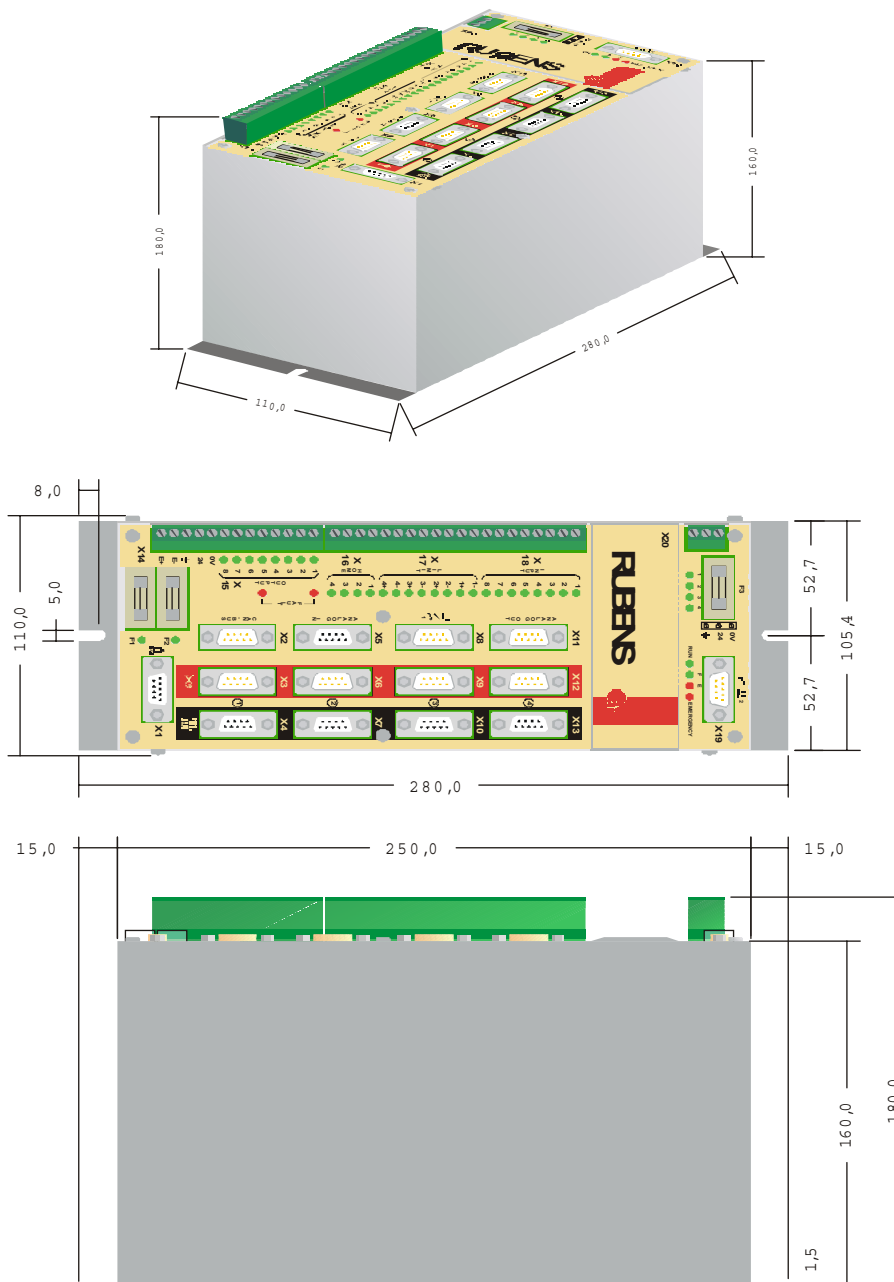

RUBENS PANEL

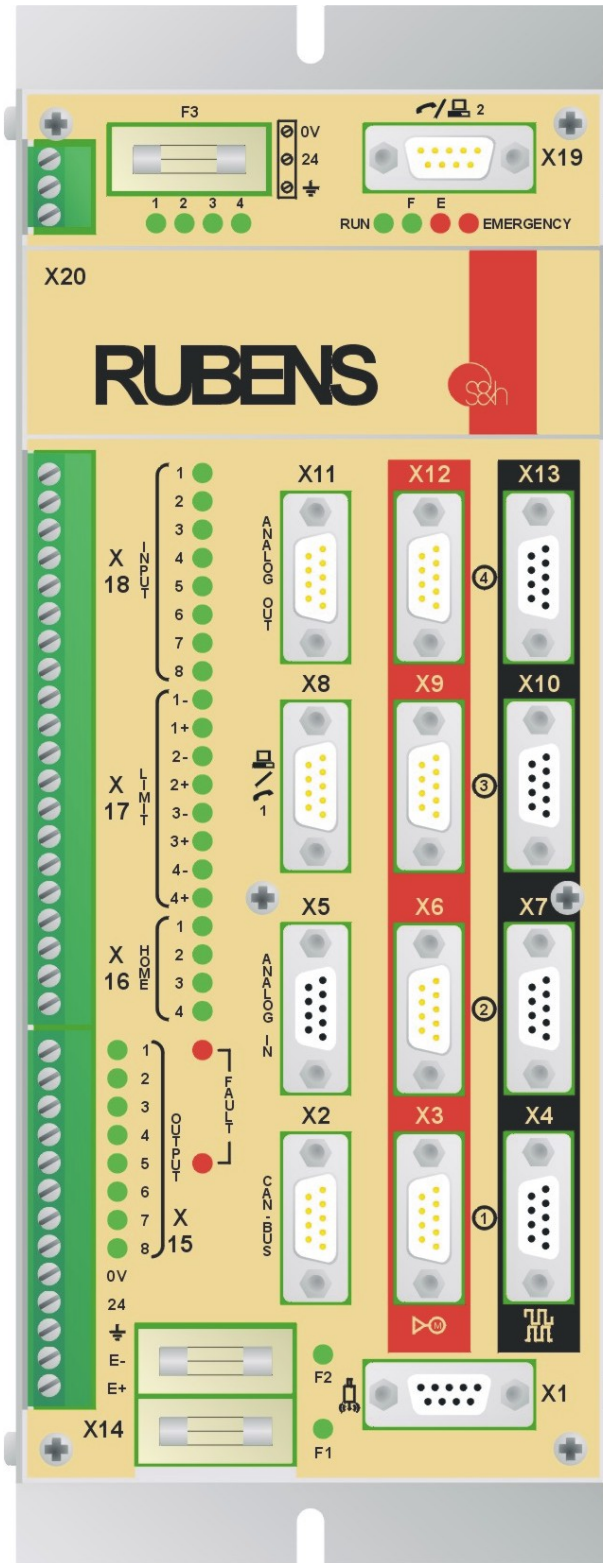

FUSE VALUE

F1 = 1A
(encoder supply)

F2 = 2,5A
(+24VDC I/O)

F3 = 0,5A
(RUBENS supply)

CONNECTORS ON THE RUBENS PANEL

CAN BUS

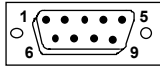

9-POLE MALE
D-CONNECTOR
X2

Pin	Signal
1	
2	CAN L
3	COM (0V)
4	
5	
6	
7	CAN H
8	
9	

ANALOGUE INPUTS

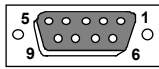

9-POLE FEMALE
D-CONNECTOR
X5

Pin	Signal	I/O
1	COM	-
2	AIN1	
3	AIN2	
4	AIN3	
5	AIN4	
6	AIN5	
7	AIN6	
8	AIN7	
9	AIN8	

SERIAL PORT

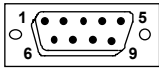

9-POLE MALE
D-CONNECTOR
X8

Pin	RS232	RS422
1		
2	Rx Rx+	
3	Tx Tx+	
4		
5	COM (0V)	
6		
7	Rts Tx-	
8	Cts Rx-	
9		

ANALOGUE OUTPUTS

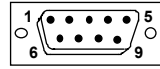

9-POLE MALE
D-CONNECTOR
X11

Pin	Signal	I/O
1	AGND(AN.REF.)	-
2	OUT1 (PWM)	○
3	AGND(AN.REF.)	-
4	Ao① (+VOUT)	○
5	GND_AZN (0V)	-
6	Ao② (+VOUT)	○
7	ENB⑤ (ENABLE)	○
8	ENB⑥ (ENABLE)	○
9	OUT2 (PWM)	○

AXIS 1 (X) DRIVER

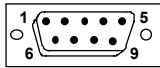

9-POLE MALE
D-CONNECTOR
X3

Pin	Signal	I/O
1	AGND(AN.REF.)	-
2	FLT① (FAULT)	
3	PULSE①	○
4		
5	GND_DRV (0V)	-
6	Ao① (+VOUT)	○
7	ENB① (ENABLE)	○
8	DIR①	○
9		

AXIS 2 (Y) DRIVER

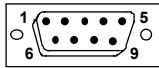

9-POLE MALE
D-CONNECTOR
X6

Pin	Signal	I/O
1	AGND(AN.REF.)	-
2	FLT② (FAULT)	
3	PULSE②	○
4		
5	GND_DRV (0V)	-
6	Ao② (+VOUT)	○
7	ENB② (ENABLE)	○
8	DIR②	○
9		

AXIS 3 (Z) DRIVER

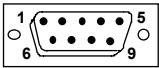

9-POLE MALE
D-CONNECTOR
X9

Pin	Signal	I/O
1	AGND(AN.REF.)	-
2	FLT③ (FAULT)	
3	PULSE③	○
4		
5	GND_DRV (0V)	-
6	Ao③ (+VOUT)	○
7	ENB③ (ENABLE)	○
8	DIR③	○
9		

AXIS 4 (W) DRIVER

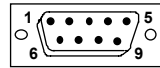

9-POLE MALE
D-CONNECTOR
X12

Pin	Signal	I/O
1	AGND(AN.REF.)	-
2	FLT④ (FAULT)	
3	PULSE④	○
4		
5	GND_DRV (0V)	-
6	Ao④ (+VOUT)	○
7	ENB④ (ENABLE)	○
8	DIR④	○
9		

AXIS 1 (X) ENCODER

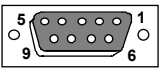

9-POLE FEMALE
D-CONNECTOR
X4

Pin	Signal	I/O
1	GND_ENC (0V)	-
2	+VENC (+5V)	-
3	ZE①+	
4	FB①+	
5	FB①-	
6		
7	ZE①-	
8	FA①-	
9	FA①+	

AXIS 2 (Y) ENCODER

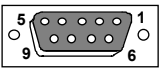

9-POLE FEMALE
D-CONNECTOR
X7

Pin	Signal	I/O
1	GND_ENC (0V)	-
2	+VENC (+5V)	-
3	ZE②+	
4	FB②+	
5	FB②-	
6		
7	ZE②-	
8	FA②-	
9	FA②+	

AXIS 3 (Z) ENCODER

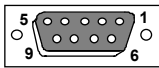

9-POLE FEMALE
D-CONNECTOR
X10

Pin	Signal	I/O
1	GND_ENC (0V)	-
2	+VENC (+5V)	-
3	ZE③+	
4	FB③+	
5	FB③-	
6		
7	ZE③-	
8	FA③-	
9	FA③+	

AXIS 4 (W) ENCODER

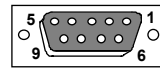

9-POLE FEMALE
D-CONNECTOR
X13

Pin	Signal	I/O
1	GND_ENC (0V)	-
2	+VENC (+5V)	-
3	ZE④+	
4	FB④+	
5	FB④-	
6		
7	ZE④-	
8	FA④-	
9	FA④+	

SERIAL PORT

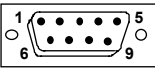

9-POLE MALE
D-CONNECTOR
X19

Pin	RS232	RS422
1		
2	Rx	Rx+
3	Tx	Tx+
4		
5	COM (0V)	
6		
7	Rts	Tx-
8	Cts	Rx-
9		



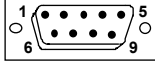

PROXIMITY



9-POLE MALE
D-CONNECTOR
X1

Pin	Signal	I/O
1	0V	-
2	+5V	-
3	TAUX	I
4	TASTD	I
5	ALED	O
6		
7		
8		
9		

TERMINALS ON THE RUBENS PANEL

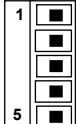
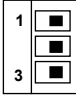
TERMINALS	PIN	SIGNAL	DESCRIPTION	I/O
X18 	1	INP1	DIGITAL INPUT No.1	
	2	INP2	DIGITAL INPUT No.2	
	3	INP3	DIGITAL INPUT No.3	
	4	INP4	DIGITAL INPUT No.4	
	5	INP5	DIGITAL INPUT No.5	
	6	INP6	DIGITAL INPUT No.6	
	7	INP7	DIGITAL INPUT No.7	
	8	INP8	DIGITAL INPUT No.8	
X17 	9	LS①-	LIMIT SWITCH FORWARD(-) AXIS ①	
	10	LS①+	LIMIT SWITCH REVERSE(+)	
	11	LS②-	LIMIT SWITCH FORWARD(-) AXIS ②	
	12	LS②+	LIMIT SWITCH REVERSE(+)	
	13	LS③-	LIMIT SWITCH FORWARD(-) AXIS ③	
	14	LS③+	LIMIT SWITCH REVERSE(+)	
	15	LS④-	LIMIT SWITCH FORWARD(-) AXIS ④	
	16	LS④+	LIMIT SWITCH REVERSE(+)	
X16 	17	HOME①	MACHINE ZERO: AXIS ①	
	18	HOME②	MACHINE ZERO: AXIS ②	
	19	HOME③	MACHINE ZERO: AXIS ③	
	20	HOME④	MACHINE ZERO: AXIS ④	
X15 	21	OUT1	DIGITAL OUTPUT No.1	○
	22	OUT2	DIGITAL OUTPUT No.2	○
	23	OUT3	DIGITAL OUTPUT No.3	○
	24	OUT4	DIGITAL OUTPUT No.4	○
	25	OUT5	DIGITAL OUTPUT No.5	○
	26	OUT6	DIGITAL OUTPUT No.6	○
	27	OUT7	DIGITAL OUTPUT No.7	○
	28	OUT8	DIGITAL OUTPUT No.8	○
X14 	29	COM_24V DC	0REF. POWER SUPPLY INPUT (0V OF THE +24VDC)	-
	30	+24VDC	+24VDC POWER SUPPLY INPUT	-
	31	GROUND		-
	32	ENC. -	0REF. ENCODER SUPPLY (0V OF THE +5/+12VDC)	-
	33	ENC. +	+5/+12VDC ENCODER SUPPLY	-
X20 	0V	COM_24V DC	0REF. POWER SUPPLY INPUT (0V OF THE +24VDC)	-
	24	+24VDC	+24VDC POWER SUPPLY INPUT	-
		GROUND		-
				-

OUTPUTS: TYPE PNP 24VDC / 300MA
 INPUTS: TYPE PNP 24VDC

SERIAL PORT CONNECTIONS

CONNECTOR: X8, X19

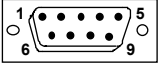
SERIAL PORT				
				
9-POLE MALE D-CONNECTOR X8				
Pin	RS232		RS422	
1				
2	Rx		Rx+	
3	Tx	○	Tx+	○
4				
5	Com (0V)			
6				
7	Rts	○	Tx-	○
8	Cts		Rx-	
9				

SERIAL PORT		
RS232 (a)		
Pin	Signal	I/O
1		
2	Rx	
3	Tx	○
4		
5	Com (0V)	-
6		
7	Rts	○
8	Cts	
9		

SERIAL PORT		
RS422 (b)		
Pin	Signal	I/O
1		
2	Rx+	
3	Tx+	○
4		
5	Com (0V)	-
6		
7	Tx-	○
8	Rx-	
9		

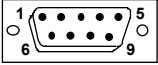
SERIAL PORT				
				
9-POLE MALE D-CONNECTOR X19				
Pin	RS232		RS422	
1				
2	Rx		Rx+	
3	Tx	○	Tx+	○
4				
5	Com (0V)			
6				
7	Rts	○	Tx-	○
8	Cts		Rx-	
9				

SERIAL PORT		
RS232 (a)		
Pin	Signal	I/O
1		
2	Rx	
3	Tx	○
4		
5	Com (0V)	-
6		
7	Rts	○
8	Cts	
9		

SERIAL PORT		
RS422 (b)		
Pin	Signal	I/O
1		
2	Rx+	
3	Tx+	○
4		
5	Com (0V)	-
6		
7	Tx-	○
8	Rx-	
9		

- Notes: (a) Factory default configuration (= RS232)
 (b) Supplied when specified

BAUD RATE	9600
DATA BIT	8
PARITY	ODD
STOP BIT	1

N.B.: Use a screened cable for the connection with the screen connected to the case of the connector.

ENCODER CONNECTIONS

CONNECTOR: X4, X7, X10, X13

AXIS 1 (X) ENCODER			ENCODER AXIS 2 (Y)			AXIS 3 (Z) ENCODER			AXIS 4 (W) ENCODER		
9-POLE FEMALE D-CONNECTOR			9-POLE FEMALE D-CONNECTOR			9-POLE FEMALE D-CONNECTOR			9-POLE FEMALE D-CONNECTOR		
X4			X7			X10			X13		
Pin	Signal	I/O	Pin	Signal	I/O	Pin	Signal	I/O	Pin	Signal	I/O
1	GND_ENC (0V)	-	1	GND_ENC (0V)	-	1	GND_ENC (0V)	-	1	GND_ENC (0V)	-
2	+VENC (+5V)	-	2	+VENC (+5V)	-	2	+VENC (+5V)	-	2	+VENC (+5V)	-
3	ZE⊕+		3	ZE⊕+		3	ZE⊕+		3	ZE⊕+	
4	FB⊕+		4	FB⊕+		4	FB⊕+		4	FB⊕+	
5	FB⊖-		5	FB⊖-		5	FB⊖-		5	FB⊖-	
6			6			6			6		
7	ZE⊖-		7	ZE⊖-		7	ZE⊖-		7	ZE⊖-	
8	FA⊖-		8	FA⊖-		8	FA⊖-		8	FA⊖-	
9	FA⊕+		9	FA⊕+		9	FA⊕+		9	FA⊕+	

Notes: The factory default configuration for the encoder is: "DIFFERENTIAL"

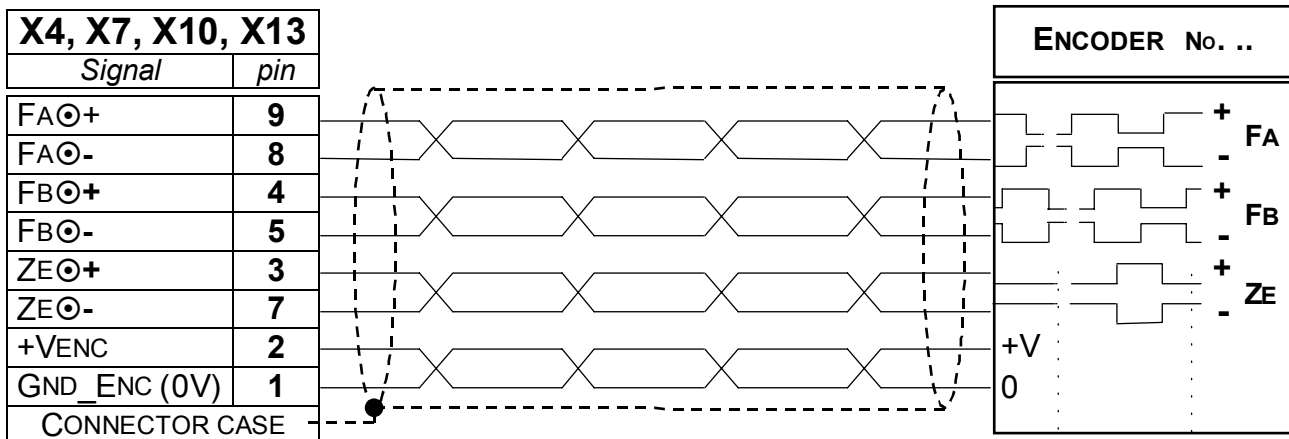

"MACHINE ZERO" microswitch (**HOME**)

It is strongly advised to use a "DIFFERENTIAL" type of encoder interface, and it is indispensable if the distance to the encoder exceeds 3 metres or if the environment in which the system operates is subject to electrical interference of any kind.

Use a screened twisted pair cable for the connection to the encoder. The screen must be isolated and connected to ground only to the casing of the connector at the controller end. Furthermore, the screen connections must be made as close as possible to the connector casing.

Maximum encoder input frequency for the RUBENS is of 800KHz (with internal RUBENS multiply we have 800_x_4=3200Khz real counting frequency)

ENCODER SUPPLY

The supply for the encoder can be taken from the RUBENS power supply or supplied from an external power source.

- **ENCODER SUPPLY: FROM THE RUBENS**
In this case, the supply that can be used for the encoder is **+5Vdc**, the maximum current is 100mA.

- **ENCODER SUPPLY: FROM AN EXTERNAL POWER SUPPLY**
In this case the encoder supply must be provided by an independent power supply, external to the PC, and connected to terminals 42 and 43 (X14 –4,5).

X14	1	■	29		-
		■	30		-
		■	31	GROUND	-
	5	■	32	ENC. - 0REF. ENCODER SUPPLY (0V OF THE +5/+12VDC)	-
		■	33	ENC. + +5/+12/+24 VDC ENCODER SUPPLY	-

DRIVE CONNECTIONS (ANALOGUE)

CONNECTORS: X3, X6, X9, X12

AXIS 1 (X) DRIVER

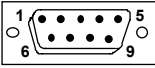

9 POLE MALE
D-CONNECTOR
X3

Pin	Signal	I/O
1	AGND(AN.REF.)	-
2	FLT \ominus (FAULT)	I
3		
4		
5	GND_DRV (0V)	-
6	Ao \ominus (+VOUT)	O
7	ENB \ominus (ENABLE)	O
8	DIR \ominus	O
9		

AXIS 2 (Y) DRIVER

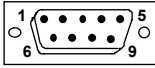

9 POLE MALE
D-CONNECTOR
X6

Pin	Signal	I/O
1	AGND(AN.REF.)	-
2	FLT \ominus (FAULT)	I
3		
4		
5	GND_DRV (0V)	-
6	Ao \ominus (+VOUT)	O
7	ENB \ominus (ENABLE)	O
8	DIR \ominus	O
9		

AXIS 3 (Z) DRIVER

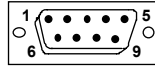

9 POLE MALE
D-CONNECTOR
X9

Pin	Signal	I/O
1	AGND(AN.REF.)	-
2	FLT \ominus (FAULT)	I
3		
4		
5	GND_DRV (0V)	-
6	Ao \ominus (+VOUT)	O
7	ENB \ominus (ENABLE)	O
8	DIR \ominus	O
9		

AXIS 4 (W) DRIVER

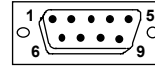

9 POLE MALE
D-CONNECTOR
X12

Pin	Signal	I/O
1	AGND(AN.REF.)	-
2	FLT \ominus (FAULT)	I
3		
4		
5	GND_DRV (0V)	-
6	Ao \ominus (+VOUT)	O
7	ENB \ominus (ENABLE)	O
8	DIR \ominus	O
9		

Note: The DIR \ominus SIGNAL must only be connected if required

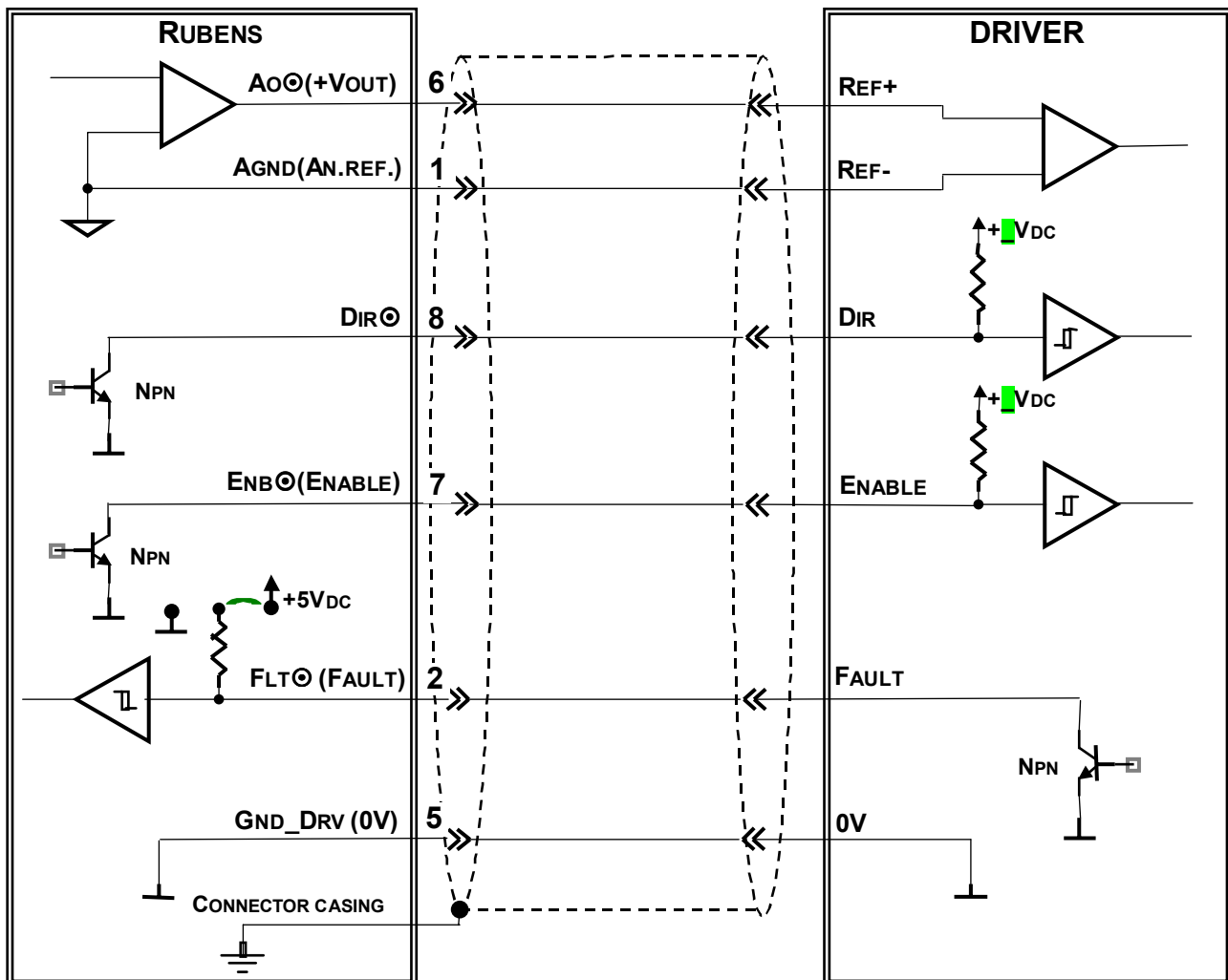

Note: The cable screen must be connected to the casing of the controller

Note: If the DRIVER does not have internal pull-up resistors, these must be provided externally

Analogue output +V_{OUT} is: $\pm 10V$ / 16 bit resolution.

DRIVER CONNECTIONS (FREQUENCY)

CONNECTORS: X3, X6, X9, X12

AXIS 1 (X) DRIVER

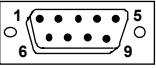

9-POLE MALE
D-CONNECTOR
X3

Pin	Signal	I/O
1		
2	FLT \ominus (FAULT)	I
3	PULSE \ominus	O
4		
5	GND_DRV (0V)	-
6		
7	ENB \ominus (ENABLE)	O
8	DIR \ominus	O
9		

AXIS 2 (Y) DRIVER

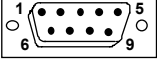

9-POLE MALE
D-CONNECTOR
X6

Pin	Signal	I/O
1		
2	FLT \ominus (FAULT)	I
3	PULSE \ominus	O
4		
5	GND_DRV (0V)	-
6		
7	ENB \ominus (ENABLE)	O
8	DIR \ominus	O
9		

AXIS 3 (Z) DRIVER

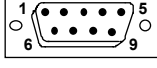

9-POLE MALE
D-CONNECTOR
X9

Pin	Signal	I/O
1		
2	FLT \ominus (FAULT)	I
3	PULSE \ominus	O
4		
5	GND_DRV (0V)	-
6		
7	ENB \ominus (ENABLE)	O
8	DIR \ominus	O
9		

AXIS 4 (W) DRIVER

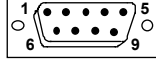

C9-POLE MALE
D-CONNECTOR
X12

Pin	Signal	I/O
1		
2	FLT \ominus (FAULT)	I
3	PULSE \ominus	O
4		
5	GND_DRV (0V)	-
6		
7	ENB \ominus (ENABLE)	O
8	DIR \ominus	O
9		

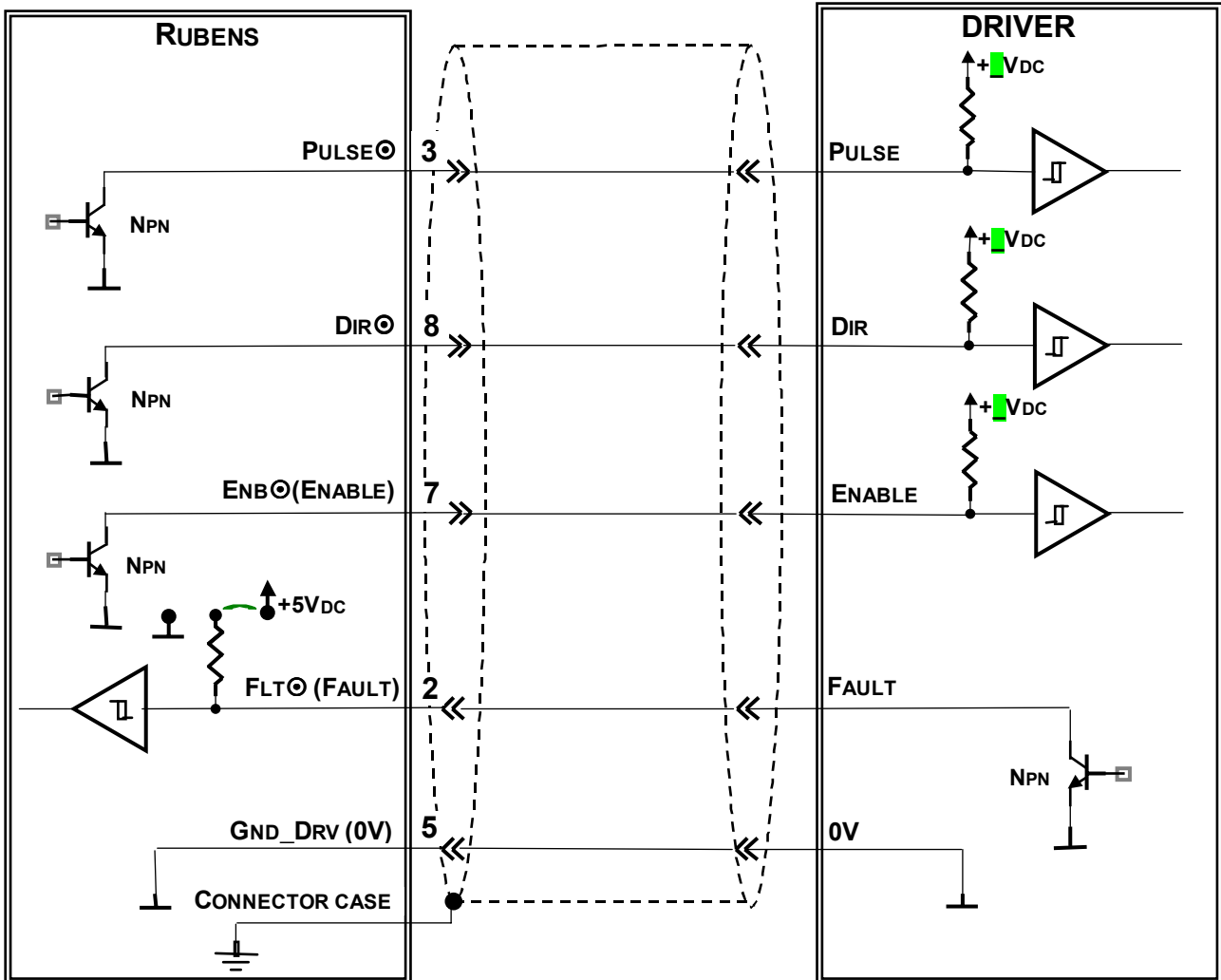



Note: The cable screen must be connected to the casing of the controller

Note: If the **DRIVER** does not have internal pull-up resistors, these must be provided externally

Note: Frequency output Pulse is maximum 800KHz with 50% duty-cycle

DIGITAL INPUT CONNECTIONS

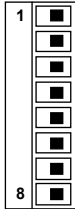
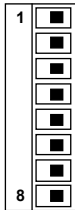
TERMINALS: X18, X17, X16, X14

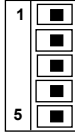
TERMINALS	PIN	SIGNAL	DESCRIPTION	I/O
 <p>X18</p>	1	INP1	DIGITAL INPUT No. 1	
	2	INP2	DIGITAL INPUT No. 2	
	3	INP3	DIGITAL INPUT No. 3	
	4	INP4	DIGITAL INPUT No. 4	
	5	INP5	DIGITAL INPUT No. 5	
	6	INP6	DIGITAL INPUT No. 6	
	7	INP7	DIGITAL INPUT No. 7	
	8	INP8	DIGITAL INPUT No. 8	
 <p>X17</p>	9	Ls①-	LIMIT SWITCH FORWARD (-) AXIS①	
	10	Ls①+	LIMIT SWITCH REVERSE (+) AXIS①	
	11	Ls②-	LIMIT SWITCH FORWARD (-) AXIS②	
	12	Ls②+	LIMIT SWITCH REVERSE (+) AXIS②	
	13	Ls③-	LIMIT SWITCH FORWARD (-) AXIS③	
	14	Ls③+	LIMIT SWITCH REVERSE (+) AXIS③	
	15	Ls④-	LIMIT SWITCH FORWARD (-) AXIS④	
	16	Ls④+	LIMIT SWITCH REVERSE (+) AXIS④	
 <p>X16</p>	17	HOME①	MACHINE ZERO : AXIS①	
	18	HOME②	MACHINE ZERO : AXIS②	
	19	HOME③	MACHINE ZERO : AXIS③	
	20	HOME④	MACHINE ZERO : AXIS④	
 <p>X14</p>	29	COM_24V DC	0REF. SUPPLY INPUT (0V DEL +24VDC)	-
	30	+24VDC	+24VDC SUPPLY INPUT	-
	31	GROUND		-
	32			
	33			

INPUT: TYPE PNP 24VDC

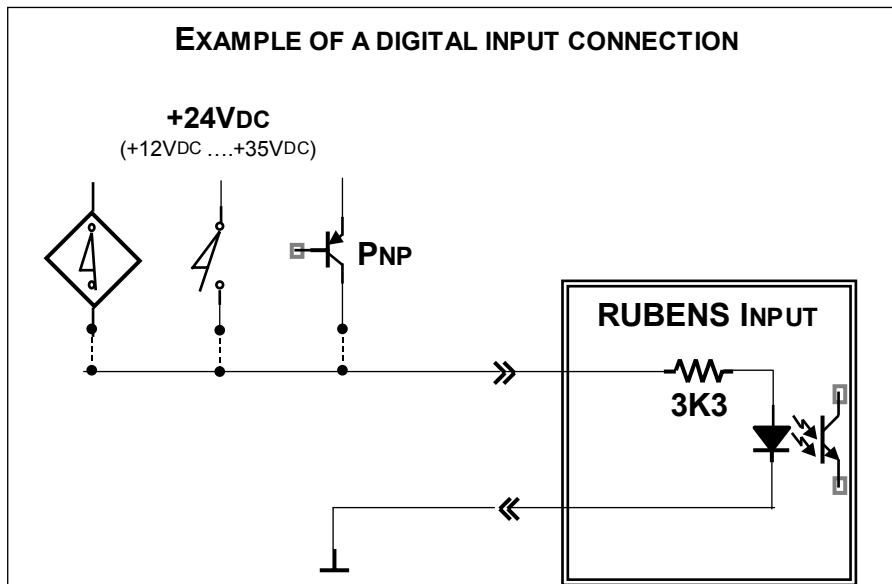

RUBENS IMAGE OF INPUTS 31....0

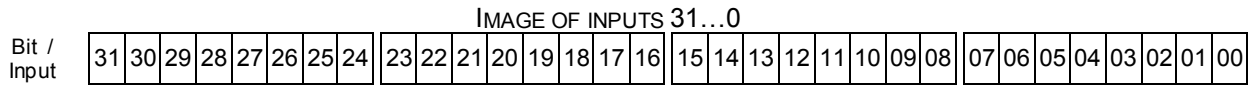

Bit	Input	Description		Connector / pin
00	INP1	DIGITAL INPUT NO.1		X18 – 1
01	INP2	DIGITAL INPUT NO.2		X18 – 2
02	INP3	DIGITAL INPUT NO.3		X18 – 3
03	INP4	DIGITAL INPUT NO.4		X18 – 4
04	INP5	DIGITAL INPUT NO.5		X18 – 5
05	INP6	DIGITAL INPUT NO.6		X18 – 6
06	INP7	DIGITAL INPUT NO.7		X18 – 7
07	INP8	DIGITAL INPUT NO.8		X18 – 8
08	LS①-	LIMIT SWITCH FORWARD (-)	AXIS①	X17 – 9
09	LS①+	LIMIT SWITCH REVERSE (+)		X17 – 10
10	LS②-	LIMIT SWITCH FORWARD (-)	AXIS②	X17 – 11
11	LS②+	LIMIT SWITCH REVERSE (+)		X17 – 12
12	LS③-	LIMIT SWITCH FORWARD (-)	AXIS③	X17 – 13
13	LS③+	LIMIT SWITCH REVERSE (+)		X17 – 14
14	LS④-	LIMIT SWITCH FORWARD (-)	AXIS④	X17 – 15
15	LS④+	LIMIT SWITCH REVERSE (+)		X17 – 16
16	HOME①	MACHINE ZERO	AXIS①	X16 – 17
17	HOME②	MACHINE ZERO	AXIS②	X16 – 18
18	HOME③	MACHINE ZERO	AXIS③	X16 – 19
19	HOME④	MACHINE ZERO	AXIS④	X16 – 20
20	FLT①	FAULT INPUT	DRIVER ①	X3 – 2
21	FLT②	FAULT INPUT	DRIVER ②	X6 – 2
22	FLT③	FAULT INPUT	DRIVER ③	X9 – 2
23	FLT④	FAULT INPUT	DRIVER ④	X12 – 2
24				
25				
26				
27				
28				
29				
30				
31				

Note: To read the inputs from the CNC program, use the instructions :

- G66 P0...P23**
- G65 P0...P23**
- G69 P0...P23**

DIGITAL OUTPUT CONNECTIONS

TERMINALS: X15

TERMINALS	PIN	SIGNAL	DESCRIPTION	I/O
	21	OUT1	DIGITAL OUTPUT No.1	O
	22	OUT2	DIGITAL OUTPUT No.2	O
	23	OUT3	DIGITAL OUTPUT No.3	O
	24	OUT4	DIGITAL OUTPUT No.4	O
	25	OUT5	DIGITAL OUTPUT No.5	O
	26	OUT6	DIGITAL OUTPUT No.6	O
	27	OUT7	DIGITAL OUTPUT No.7	O
	28	OUT8	DIGITAL OUTPUT No.8	O

	29	COM_24V DC	0REF. SUPPLY INPUT (0V DEL +24VDC)	-
	30	+24VDC	+24VDC SUPPLY INPUT	-
	31	GROUND		-
	32			
	33			

OUTPUTS: TYPE PNP 24VDC / 300mA

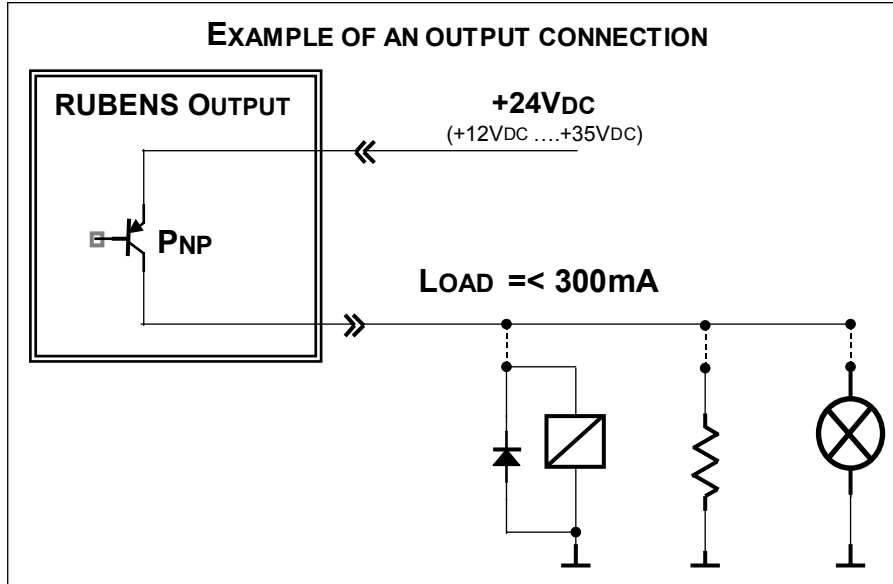

RUBENS IMAGE OF THE OUTPUTS 31....0

IMAGE OF THE OUTPUTS 31...0

Bit / input	31	30	29	28	27	26	25	24	23	22	21	20	19	18	17	16	15	14	13	12	11	10	09	08	07	06	05	04	03	02	01	00
----------------	----	----	----	----	----	----	----	----	----	----	----	----	----	----	----	----	----	----	----	----	----	----	----	----	----	----	----	----	----	----	----	----

Bit	Output	Description	Connector / pin
00	OUT1	DIGITAL OUTPUT NO. 1	X15 – 21
01	OUT2	DIGITAL OUTPUT NO. 2	X15 – 22
02	OUT3	DIGITAL OUTPUT NO. 3	X15 – 23
03	OUT4	DIGITAL OUTPUT NO. 4	X15 – 24
04	OUT5	DIGITAL OUTPUT NO. 5	X15 – 25
05	OUT6	DIGITAL OUTPUT NO. 6	X15 – 26
06	OUT7	DIGITAL OUTPUT NO. 7	X15 – 27
07	OUT8	DIGITAL OUTPUT NO. 8	X15 – 28
08	DIR①	DIRECTION OUTPUT	<i>DRIVER①</i> X3 – 7
09	ENB①	ENABLE OUTPUT	
10	DIR②	DIRECTION OUTPUT	<i>DRIVER②</i> X6 – 7
11	ENB②	ENABLE OUTPUT	
12	DIR③	DIRECTION OUTPUT	<i>DRIVER③</i> X9 – 7
13	ENB③	ENABLE OUTPUT	
14	DIR④	DIRECTION OUTPUT	<i>DRIVER④</i> X12 – 7
15	ENB④	ENABLE OUTPUT	
16	ENB⑤	ENABLE OUTPUT	<i>DRIVER⑤</i> X11 – 7
17	ENB⑥	ENABLE OUTPUT	<i>DRIVER⑥</i> X11 – 8
18			
19			
20			
21			
22			
23			
24			
25			
26			
27			
28			
29			
30			
31			

Note: To write the outputs from the CNC program use the instructions :
G67 P0...P7
G68 P0...P7

ANALOGUE INPUT CONNECTIONS

CONNECTOR: X5

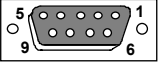
ANALOGUE INPUTS		
		
9-POLE FEMALE D-CONNECTOR		
X5		
Pin	Signal	I/O
1	COM	-
2	AIN1	
3	AIN2	
4	AIN3	
5	AIN4	
6	AIN5	
7	AIN6	
8	AIN7	
9	AIN8	

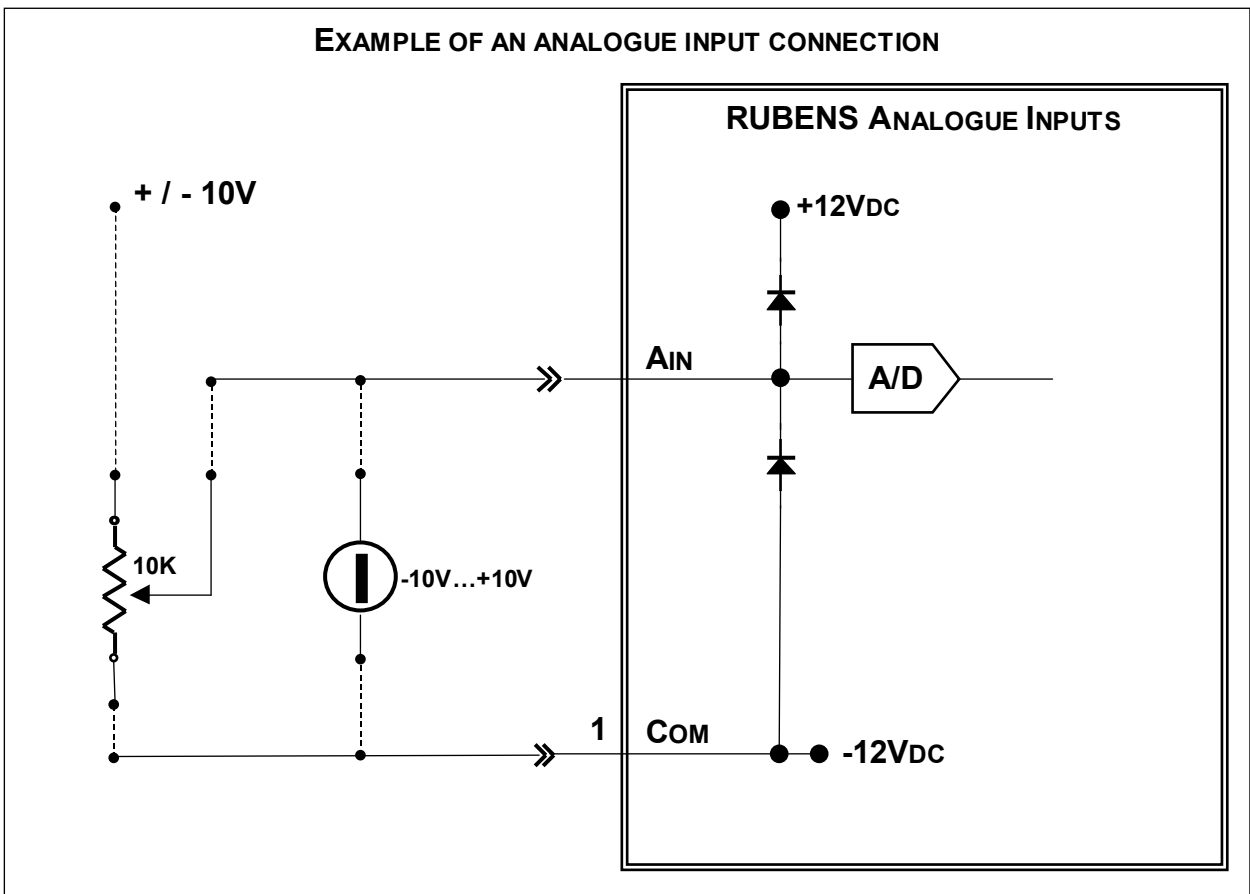

ANALOGUE OUTPUT CONNECTIONS

CONNECTOR: X11

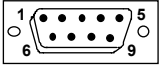
ANALOGUE OUTPUTS		
		
9-POLE MALE D-CONNECTOR X11		
Pin	Signal	I/O
1	AGND(AN.REF.)	-
2	Out1 (PWM)	O
3	AGND(AN.REF.)	-
4	Ao⊙ (+Vout)	O
5	GND_DRV (0V)	-
6	Ao⊙ (+Vout)	O
7	ENB⊙(ENABLE)	O
8	ENB⊙(ENABLE)	O
9	OUT2 (PWM)	O

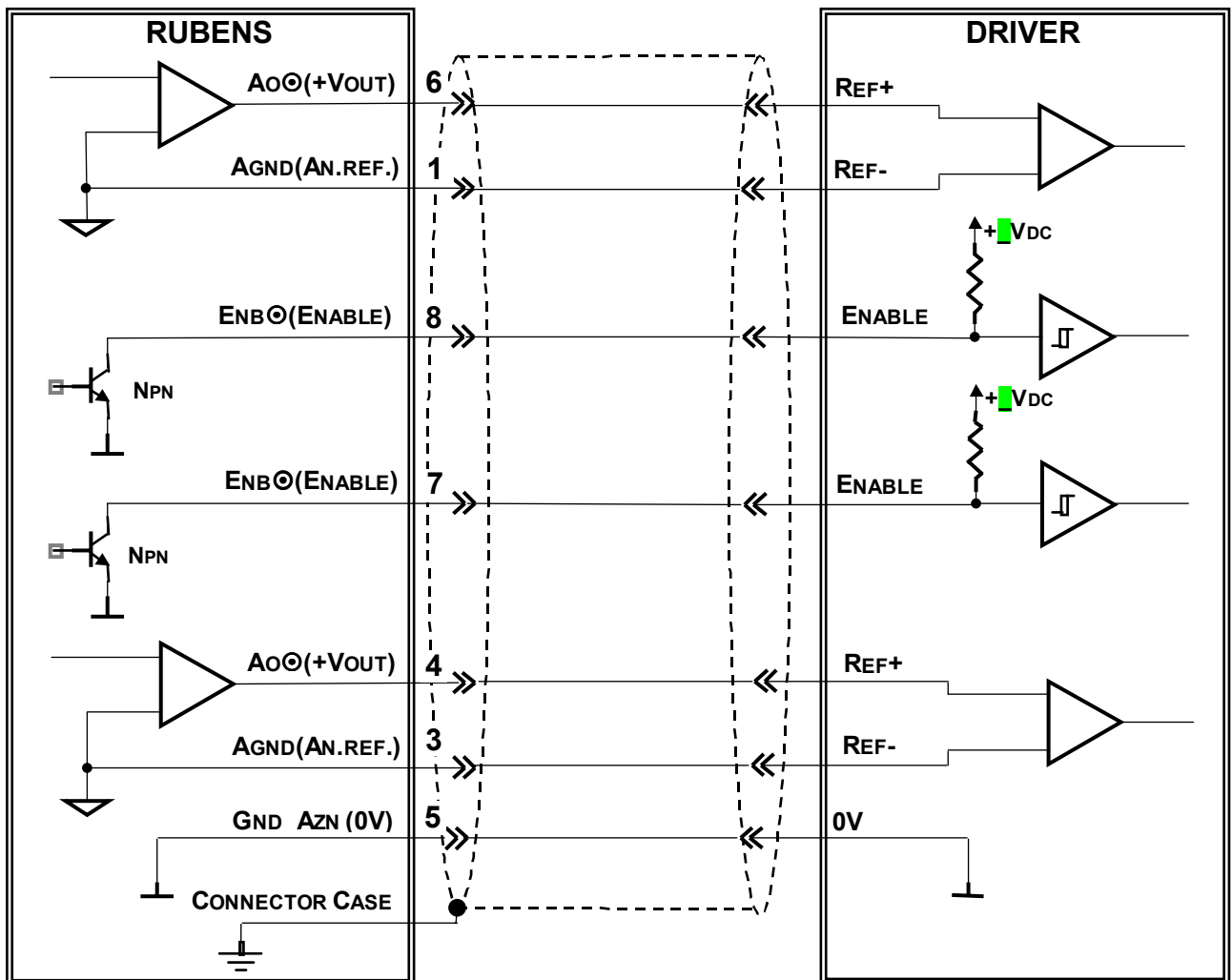

CONNECTION OF THE PROXIMITY SWITCH

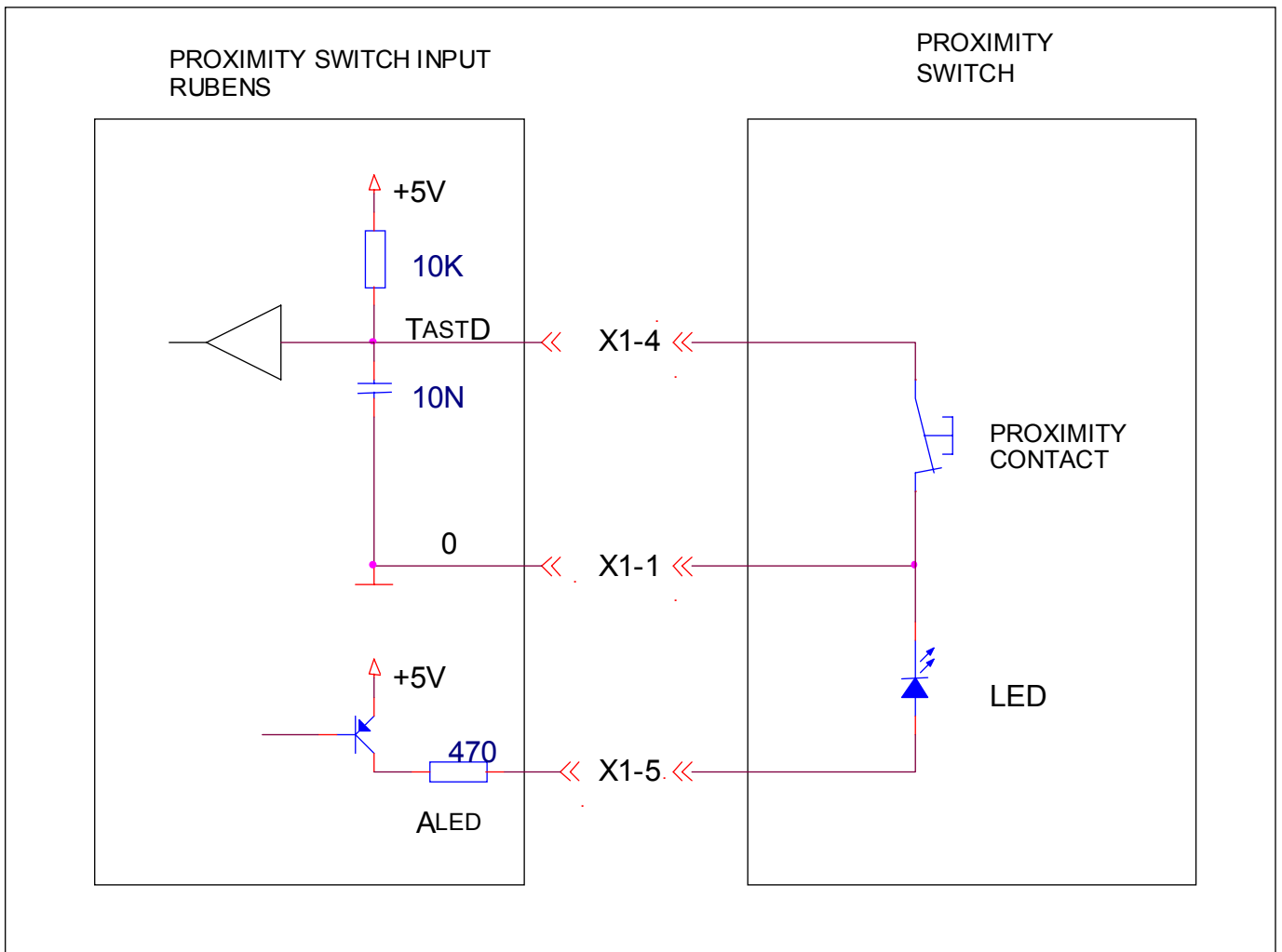
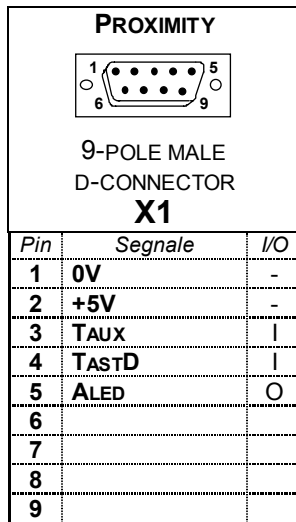

CAN-BUS CONNECTION

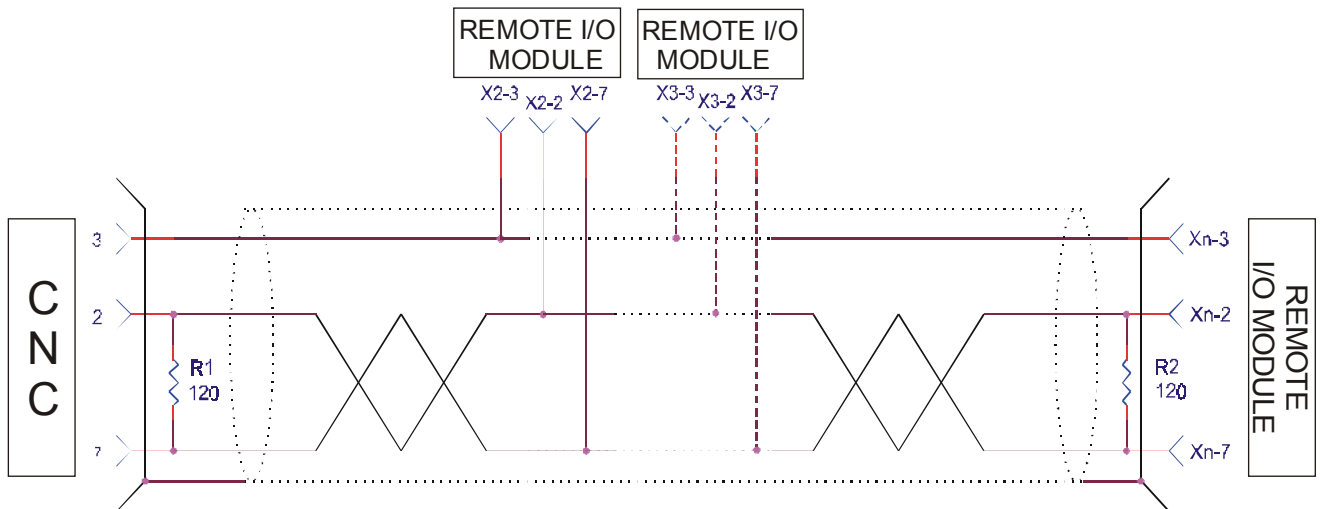

The termination resistances (120Ω) are placed at the beginning, in the connector to the CNC, and the end of the cable (see figure).
The devices connected in intermediate positions do not require a termination resistance.

Belden type 3082A or equivalent cable is recommended.

The screen must be connected to the casing of the connector.

INSTALLATION RECOMMENDATIONS

1. The network units must be connected in cascade.
2. Avoid completely any star or tree topography for the connections (see the following figure).

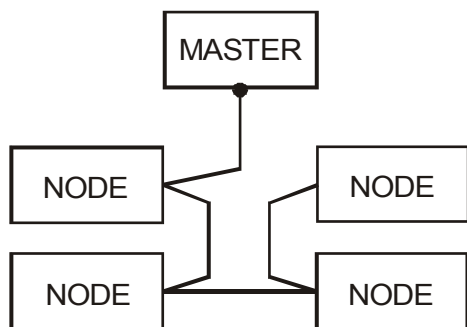

**PERMITTED
CONFIGURATION**

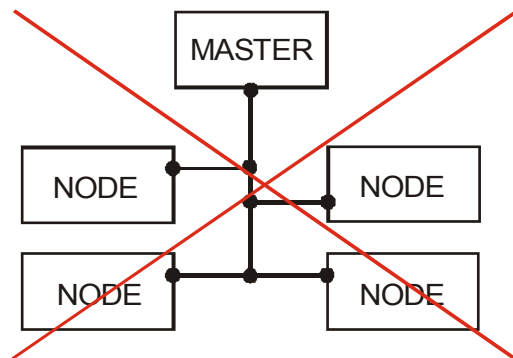

**FORBIDDEN
CONFIGURATION**

CAN Network Configuration

3. Use the same type of cable for the whole installation (screened, twisted pair)