

## 6161 S

**Angle de pas  
Schrittwinkel  
Step angle** 7.5 °

**Diamètre  
Durchmesser  
Diameter** 57 mm

**Poids  
Gewicht  
Weight** 275 g

**Couple de retenue  
Haltemoment  
Holding torque** 120/100 mNm

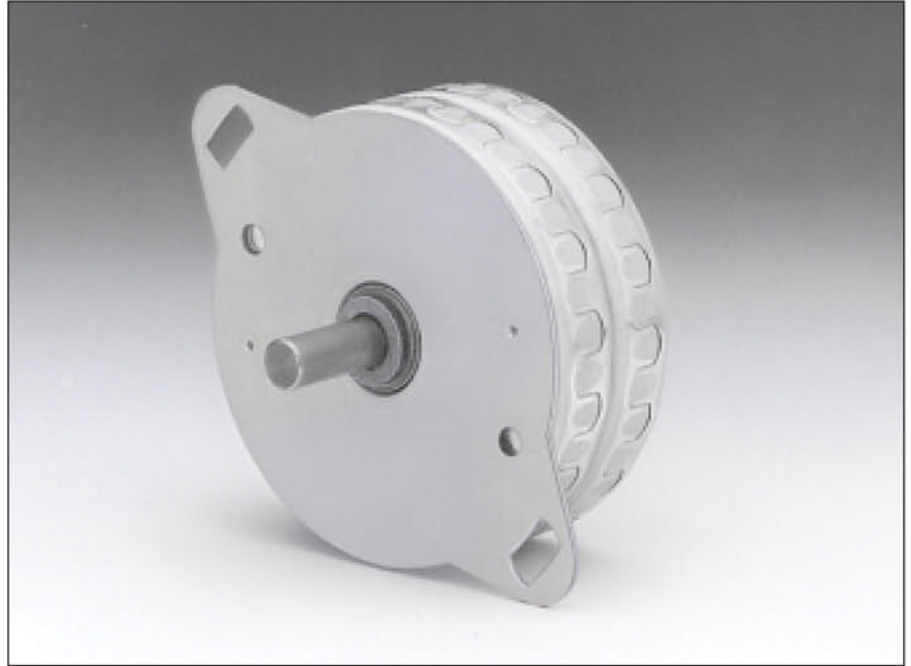

		Résistance de phase Phasenwiderstand Phase resistance $\Omega$	Induct. de phase Phaseninduktivität Phase inductance mH	Courant de phase Phasenstrom Phase current A	Couple de retenue Haltemoment Holding torque mNm	Puissance nominale Nennleistung Nominal power W	Code câble Kabelcode Cable-code	
<b>bipolar</b>	<b>6161-2S-2.2</b>	2.2	3.6	1.37	120	8.3	rose rosa pink	
	<b>6161-2S-9</b>	9	15.0	0.68	120	8.3	rouge rot red	
	<b>6161-2S-36</b>	36	56.0	0.34	120	8.3	bleu blau blue	
<b>unipolar</b>	<b>6161-4S-2.2</b>	2.2	2.0	1.37	100	8.3	rose rosa pink	
	<b>6161-4S-9</b>	9	8.0	0.68	100	8.3	rouge rot red	
	<b>6161-4S-36</b>	36	30.0	0.34	100	8.3	bleu blau blue	

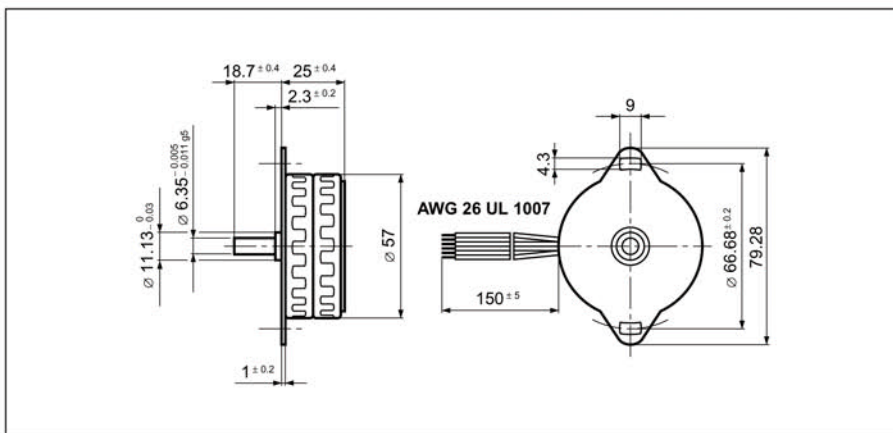

Pas/t Schritte/U Steps/rev	<b>48</b>
Précision/pas Schrittgenauigkeit Step accuracy	<b>± 7 %</b>
Inertie du rotor Rotorträgheitsmoment Rotor inertia	<b>30 gcm<sup>2</sup></b>
Classe d'isolation Isolationsklasse Insulation class	<b>E 120 °C</b>
Protection Schutzart Protection	<b>DIN 40050 IP 30</b>
Tension d'essai Prüfspannung Test voltage	<b>500 VAC</b>
Couple résiduel Restmoment Detent torque	<b>8 mNm</b>

**Caractéristiques dynamiques**  
**Dynamische Daten**  
**Dynamic characteristics**

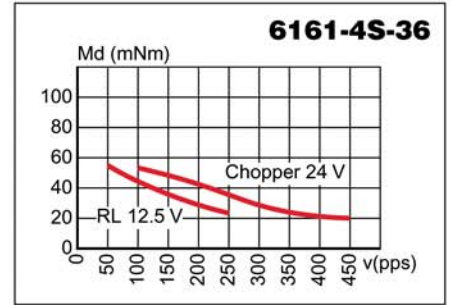
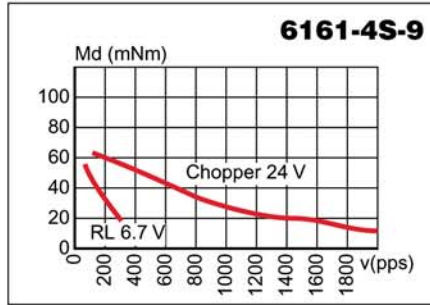
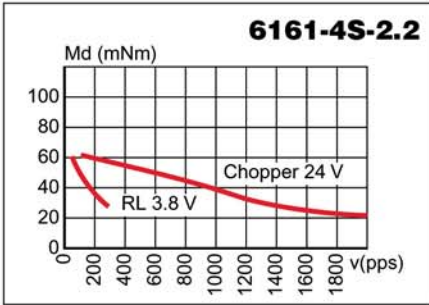
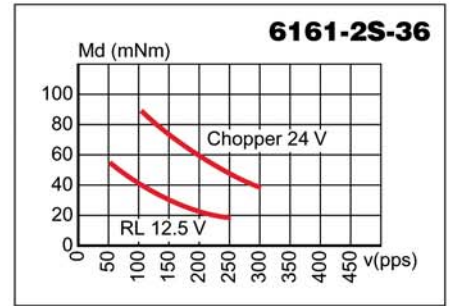
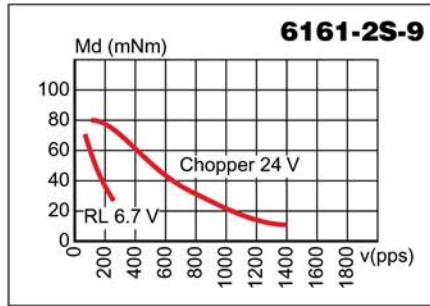
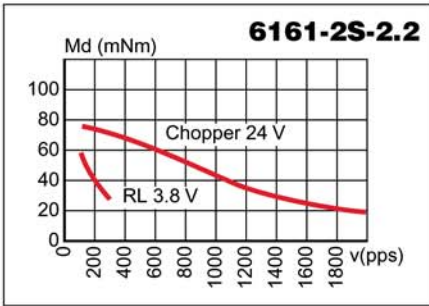

**Caractéristiques statiques**  
**Statische Daten**  
**Static characteristics**

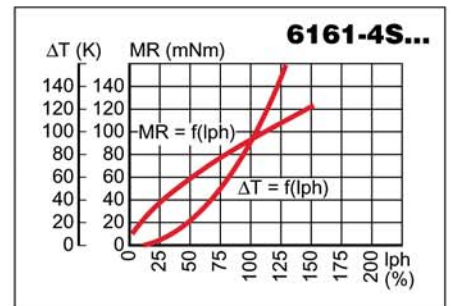
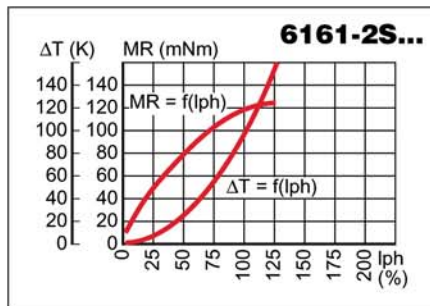

Possibilités d'exécutions adaptées sur demande.  
 Auf Wunsch werden kundenspezifische Anforderungen berücksichtigt.  
 Special requirements can be made to customer specification.

**ACP&D Limited**  
 Units 6 & 9A,  
 Charlestown Industrial Estate,  
 Robinson Street,  
 Ashton-under-Lyne,  
 Lancashire, OL6 8NS.

Tel: +44 (0)161 343 1884  
 Fax: +44 (0)161 339 0650  
 e-mail: sales@acpd.co.uk  
 Websites: www.acpd.com &  
 www.acpd.co.uk

