



# Operation Manual

J D : 5 3 3

*AC Inverter*

**380 to 460V 1HP~400HP**

**200 to 230V 1HP~100HP**

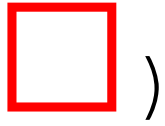

M O T O R C O M P A N Y

# Operation Manual

J D : 5 3 3

*AC Inverter*

**380 to 460V 1HP~400HP**

**200 to 230V 1HP~100HP**

---

The GA7200 is a high-performance/low noise general-purpose inverter. This manual describes the operation procedures for the digital operator (JNEP--12) provided with the GA7200.

A thorough understanding of this operation manual and the GA7200 installation manual is recommended before using the GA7200.

---

# CONTENTS

	Page
<b>1. OUTLINE .....</b>	<b>5</b>
1.1 MAIN FUNCTIONS.....	5
1.2 DIGITAL OPERATOR KEYPAD.....	6
<b>2. DRIVE MODE AND PROGRAM MODE.....</b>	<b>8</b>
2.1 DISPLAY CONTENTS .....	9
2.2 CONSTANT GROUPS.....	10
<b>3. CONSTANTS SETTING AND CHANGE.....</b>	<b>11</b>
3.1 STANDARD FACTORY SETTING.....	11
3.2 FREQUENCY REFERENCE SETTING AND CHANGE .....	11
3.3 CONSTANTS CHANGE AND FUNCTION SELECTION.....	12
3.4 OPERATION ERRORS “ $\square$ PE $\square$ $\square$ ” .....	13
<b>4. WIRING.....</b>	<b>14</b>
4.1 CONNECTION DIAGRAMS .....	14
4.2 TERMINAL FUNCTIONS (MAIN CIRCUIT).....	16
<b>5. DIGITAL OPERATOR PROGRAMMING.....</b>	<b>18</b>
<b>6. PROGRAM MODE SETTING AND CHANGE .....</b>	<b>20</b>
6.1 V/f PATTERN SETTING .....	Sn-02..... 23
6.2 ACCEL/DECEL TIME SETTING.....	bn-01 to-04 (Sn-06, Sn-15 to -18)..... 24
6.3 INPUT SIGNAL SELECTION .....	Sn-04..... 27
6.4 PROTECTIVE CHARACTERISTICS SELECTION.....	Sn-10 to-14 ..... 28
6.5 MULTI-FUNCTION INPUT SELECTION.....	Sn-04, Sn-15 to 19, bn-09..... 31
6.6 CONTACT OUTPUT SELECTION .....	Sn-20..... 37
6.7 FREQUENCY REFERENCE CHANGE .....	bn-05, -06..... 40
6.8 DC INJECTION BRAKING (DC).....	Cn-10 to -13 ..... 41
6.9 FULL-RANGE DC INJECTION BRAKING STOP (DCB STOP).....	Sn-04=10 XX, Cn-12..... 42
6.10 UPPER/LOWER LIMIT OF FREQUENCY REFERENCE.....	Cn-14, -15 ..... 43
6.11 PROHIBITED (SKIP) FREQUENCY.....	Cn-16 to -19 ..... 44
6.12 DISPLAY MODE CHANGE.....	Cn-20..... 45
6.13 STALL PREVENTION LEVEL WHILE RUNNING .....	Cn-30 (Sn-10) ..... 46
6.14 AUTO RESET/RESTART OPERATION AT FAULT .....	Cn-36..... 47
6.15 INITIALIZING CONSTANTS.....	Sn-03..... 48

---

<b>7. CONSTANTS/FUNCTION LIST .....</b>	<b>50</b>
7.1 FREQUENCY REFERENCE.....An-□ □ .....	50
7.2 CONSTANT CHANGE WHILE RUNNING .....	bn-□ □ ..... 51
7.3 SYSTEM CONSTANTS.....Sn-□ □ .....	55
■ Inverter Capacity Selection .....	Sn-01..... 62
■ V/f Pattern Selection .....	Sn-02..... 66
■ Operation Mode Selection 1.....	Sn-04..... 70
■ Operation Mode Selection 2.....	Sn-05..... 73
■ Operation Mode Selection 3.....	Sn-06..... 74
■ Operation Mode Selection 4.....	Sn-07..... 77
■ Operation Mode Selection 5.....	Sn-08..... 78
■ Operation Mode Selection 6.....	Sn-09..... 79
■ Protective Characteristic Selection 1 .....	Sn-10..... 80
■ Protective Characteristic Selection 2 .....	Sn-11 ..... 82
■ Protective Characteristic Selection 3 .....	Sn-12..... 83
■ Protective Characteristic Selection 4 .....	Sn-13..... Not Used
■ Protective Characteristic Selection 5 .....	Sn-14..... 84
7.4 MULTI-FUNCTION CONTACT INPUT SELECTION.....	Sn-15 to -18 ..... 85
7.5 MULTI-FUNCTION ANALOG INPUT SELECTION.....	Sn-19..... 97
7.6 MULTI-FUNCTION CONTACT OUTPUT SELECTION... Sn-20 to -22 .....	98
7.7 CONTROL CONSTANTS .....	Cn-□ □ ..... 102
7.8 MONITOR DISPLAY.....	Un-□ □ ..... 118
<b>8. FAULT DISPLAY AND TROUBLESHOOTING .....</b>	<b>120</b>
<b>9. GA7200 TERMINAL FUNCTIONS .....</b>	<b>124</b>
<b>10. APPENDIX (OPTIONS AND PERIPHERALS) .....</b>	<b>125</b>
10.1 OPTION CARDS .....	125
10.2 ANALOG OPERATOR .....	126
10.3 BRAKING RESISTOR AND BRAKING UNIT .....	127
10.4 AC REACTOR .....	129
10.5 NOISE FILTER .....	130

---

# 1. OUTLINE

## 1.1 MAIN FUNCTIONS

<b>Function</b>	<b>Description</b>
Drive Mode	GA7200 can be operated easily with the digital operator.
Program Mode	Function selection and constant setting for GA7200 can be performed with the digital operator.
Monitor Function	Monitoring of output frequency, output current, output voltage or status of run / stop commands can be performed with the digital operator.
Fault Contents Display	If a fault occurs, its contents order of occurrence is displayed. When the power supply is turned ON, maintenance inspection or troubleshooting can be performed since fault is recorded.

## 1.2 DIGITAL OPERATOR KEYPAD

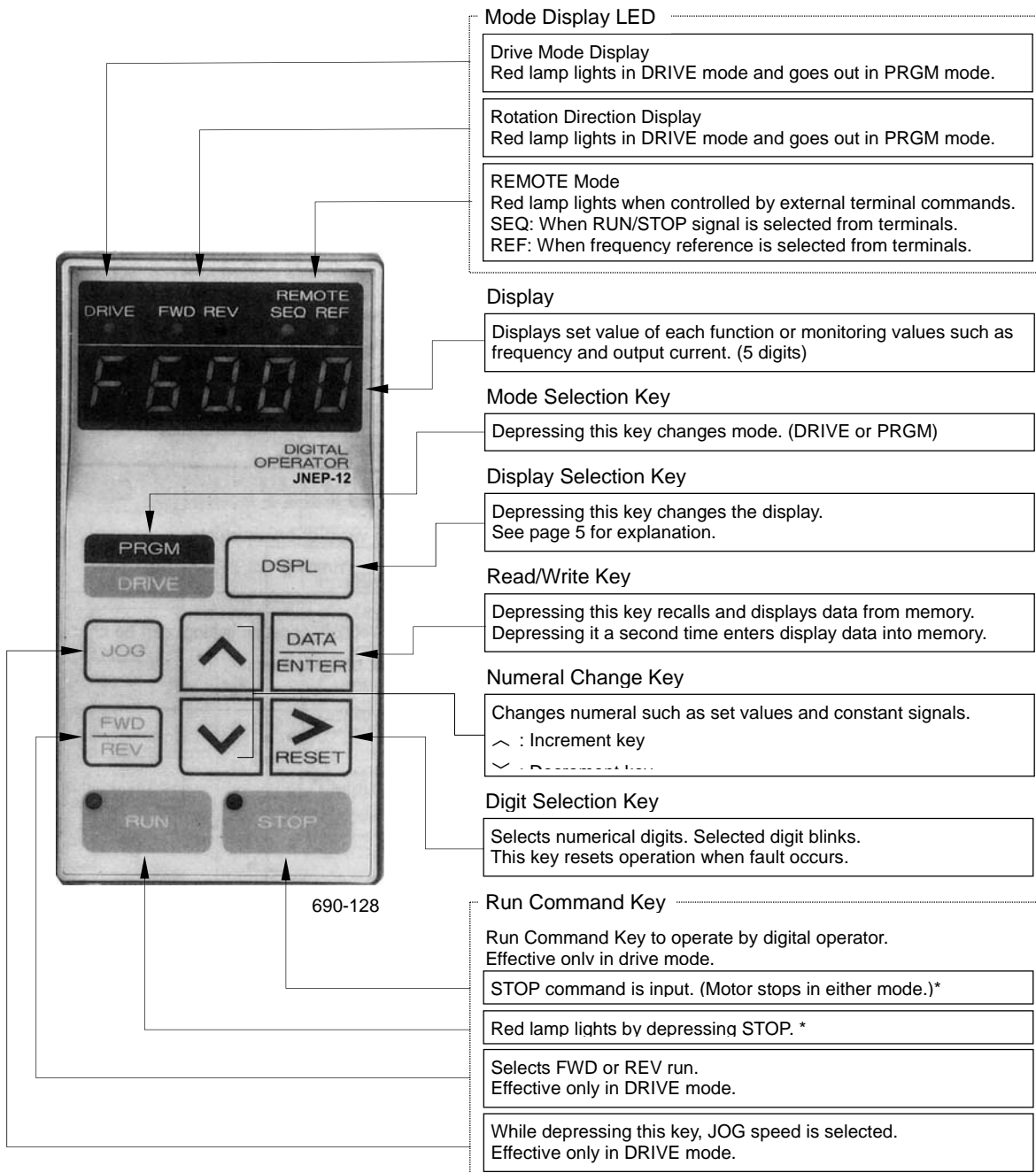

\* RUN or STOP lamp changes in accordance with the following operations.

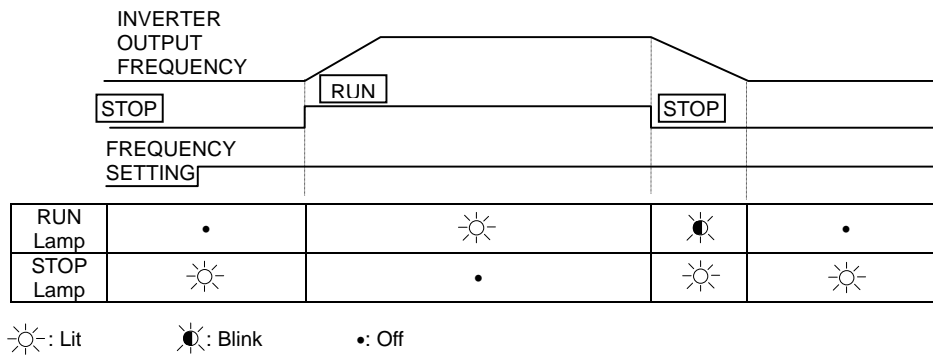







---

## 2. DRIVE MODE AND PRGM (PROGRAM) MODE

Selection of DRIVE mode or PRGM mode can be performed by using the  key when the inverter is stopped. When function selection or a change of set value is required, switch to the PRGM mode.

DRIVE mode functions	<ul style="list-style-type: none"><li>• Operation is enabled.</li><li>• An operation can be performed by  </li><li> and  keys.</li><li>• Frequency reference value or bn constants can be changed while running.</li></ul>
PRGM mode functions	<ul style="list-style-type: none"><li>• Program (function selection, constant setting) can be changed.</li></ul> <p>Note: Cannot be performed while running.</p>

## 2.1 DISPLAY CONTENTS

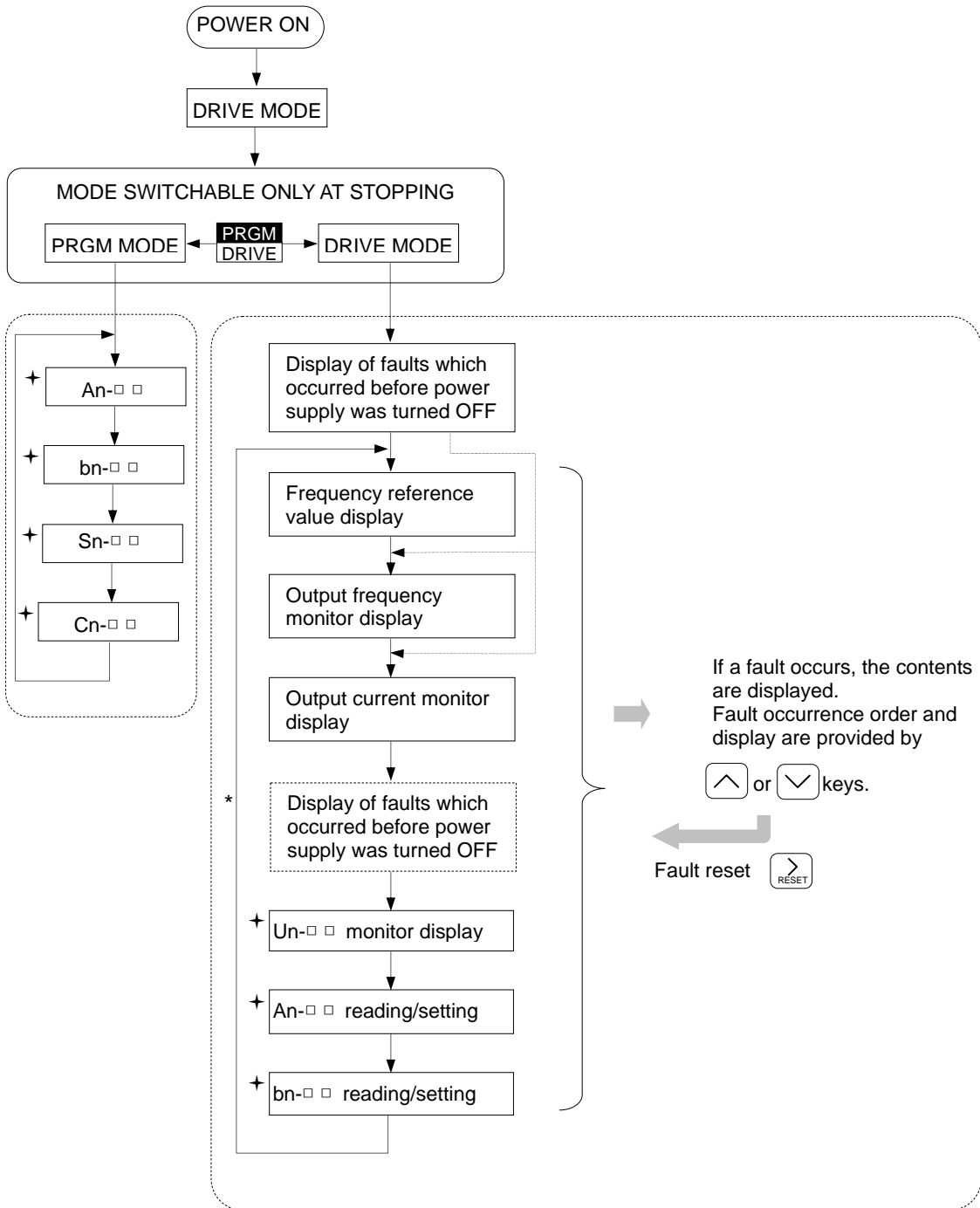

\* The constant group to be displayed is changed each time display selection key **DSPL** is depressed.

+For details of constants ( An-□ □, bn-□ □, Cn-□ □, Sn-□ □, Un-□ □, refer to Section 7, "CONSTANTS/FUNCTION LIST."

## 2.2 CONSTANT GROUPS

Constants of GA7200 are classified as follows:

Constant Group	Contents
An-□ □	Frequency reference setting
bn-□ □	Constant group able to be changed while running
Cn-□ □	Constant, among control constant groups, related to operation change characteristics
Sn-□ □	Constant, among system constant groups, to be used for function selection

The ability to set or read the different groups of constants is determined by Sn-03 as shown below.

Sn-03	DRIVE Mode		PRGM Mode		Remarks
	Setting	Reading	Setting	Reading	
<u>0000</u>	An, bn	Sn, Cn	An, bn, Sn, Cn	...	Factory set
0101	An	bn, Sn, Cn	An	bn, Sn, Cn	*

\* It is recommended that Sn-03 be set to 0101 and reading mode entered after test run adjustment.

Note: To read the Sn or Cn constants while in the DRIVE mode, depress the DSPL key with



key depressed.

## 3. CONSTANTS SETTING AND CHANGE







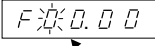

### 3.1 STANDARD FACTORY SETTING

Contents	Set Value
Frequency Reference Input	Can be set by digital operator.
Run Command Input	Can be set by digital operator. (RUN/STOP/FWD/REV/JOG)
V/f Pattern	60Hz, constant torque characteristics (Standard motor)
Acceleration Time	10 seconds
Motor Protection	Electronic overload thermal protection (Standard motor)

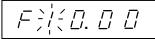
Note: For more details, refer to Section 7 "CONSTANTS/FUNCTION LIST."

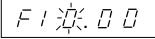
### 3.2 FREQUENCY REFERENCE SETTING AND CHANGE

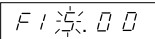

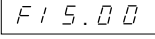







(Example) Frequency reference value is set to 15Hz.

Description	Keypad Operation	Digital Operator Display	Remarks
<ul style="list-style-type: none"> <li>Frequency reference value is displayed.</li> </ul>		 <p style="text-align: center;">Blinking</p>	
<ul style="list-style-type: none"> <li>Set or change reference value. (Input "1").</li> </ul>	 		
<ul style="list-style-type: none"> <li>Select digit.</li> </ul>			
<ul style="list-style-type: none"> <li>Set or change reference value. (Input "5".)</li> </ul>	 		
<ul style="list-style-type: none"> <li>Write-in constant.</li> </ul>			Stops blinking for 2 seconds.

### 3.3 CONSTANTS CHANGE AND FUNCTION SELECTION

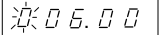
- All constants are changed and functions are selected in the same manner.
- When changing Cn-□□ and Sn-□□ constants, program mode must be selected.

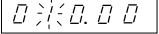
(Example) Jog frequency (An-09) set value is changed from 6Hz to 10Hz.

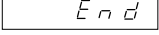
Description	Keypad Operation	Digital Operator Display	Remarks
<ul style="list-style-type: none"> <li>• Constant group to be set or changed is displayed.</li> </ul>			
<ul style="list-style-type: none"> <li>• Select constant No. to be set or changed.</li> </ul>	 		
<ul style="list-style-type: none"> <li>• Constant set value is displayed.</li> </ul>			
<ul style="list-style-type: none"> <li>• Constant is set or changed.</li> </ul>	 		
<ul style="list-style-type: none"> <li>• Set value is written in.</li> </ul>			("End" is displayed for 0.5 second). Confirm "End" displayed for each constant.

### 3.4 OPERATION ERRORS “ $\alpha P E$ □ □”

The constant setting fault  $\alpha P E$  is checked when power is applied or **PRGM** is changed to **DRIVE** mode. Digital operator displays faults if the  $\alpha P E$  is detected. The fault contact output of the inverter is not executed. If the following “conditions” occur at power ON or changing **PRGM** into **DRIVE**, it becomes  $\alpha P E$ .

Display	Fault	Conditions	Example
$\alpha P E 01$	kVA Constant Setting Fault (Sn-01)	<ul style="list-style-type: none"> <li>When 460V class constant is set for 230V class inverter or 230V class constant is set for 460V.</li> </ul>	
$\alpha P E 02$	Constant Setting Range Fault	<ul style="list-style-type: none"> <li>When “out of setting range” constant is set.</li> </ul>	
$\alpha P E 03$	Multi-function Input Setting Fault (Sn-15 to-18)	<p>When multi-function inputs Sn-15 to -18 are set as follows:</p> <ul style="list-style-type: none"> <li>Set values are not arranged in numerical order. (including equal values)</li> <li>Both search references “61” and “62” are set.</li> <li>Up command (set value = 10) and DOWN command (set value = 11) cannot be set simultaneously.</li> <li>Up command (set value = 10), DOWN command (set value = 11) and accel prohibit command (set value = 0A) are set together.</li> <li>More than two set values except FF are set.</li> </ul>	Sn-15 = 3 Sn-16 = 4 Sn-17 = 6 Sn-18 = 5
$\alpha P E 10$	V/f Data Set Fault (Cn-02 to-08)	<p>When Cn-02 to 08 do not satisfy the following conditions.</p> <ul style="list-style-type: none"> <li><math>F_{max} \geq F_A &gt; F_B \geq F_{min}</math>. (Cn-02) (Cn-04) (Cn-05) (Cn-07)</li> </ul>	Cn-02 = 50 Cn-04 = 60 Cn-05 = 3 Cn-07 = 1.5
$\alpha P E 11$	Constant Set Fault	<p>When any following set fault:</p> <ul style="list-style-type: none"> <li>Carrier frequency upper limit (Cn-23) &gt; 5kHz and Carrier frequency lower limit (Cn-24) <math>\leq</math> 5kHz.</li> <li>Carrier frequency proportional Gain (Cn-25) &gt; 6 and (Cn-23) &lt; (Cn-24)</li> </ul>	Cn-23 = 6kHz Cn-24 = 5kHz
$E r r$	Constant Write-in Fault	<ul style="list-style-type: none"> <li>The constant is not written in correctly to NV-RAM. (Only at initialization)</li> </ul>	

## 4. WIRING

GA7200 has been programmed to operate from the digital operator when shipped from the factory. Therefore, just connecting the main circuit power enables drive operation.

Note: When external signals or external devices and digital operator are used, refer to Section 7, "CONSTANTS/FUNCTION LIST", in this manual.

### 4.1 CONNECTION DIAGRAM

#### 230V Class

- 10 HP (7.5kW, 13.7kVA) or smaller

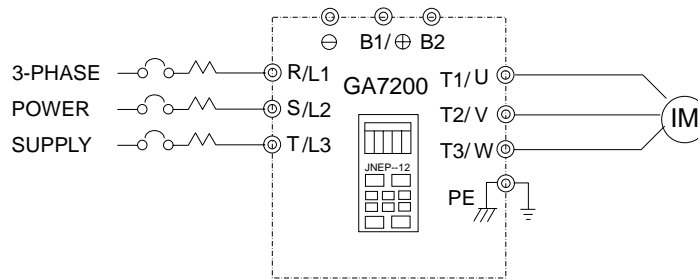

- 15/20 HP (11/15kW, 20.6/27.4kVA)

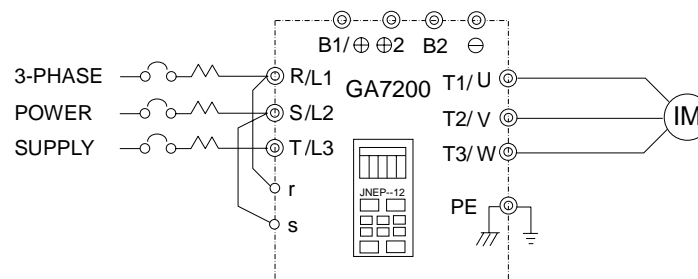

- 25 HP (18.5kW, 34kVA) or larger

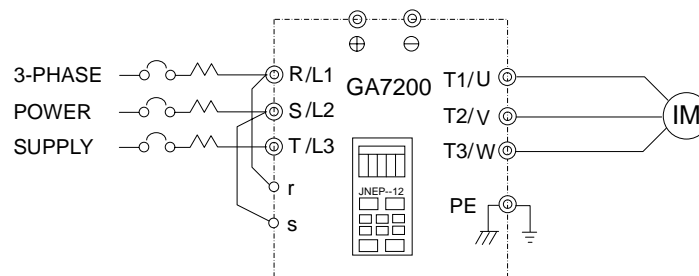

## 460V Class

- 10 HP (7.5kW, 13.7kVA) or smaller

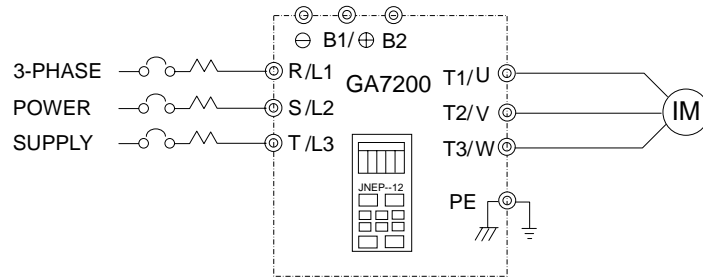

- 15/20 HP (11/15kW, 20.6/27.4kVA)

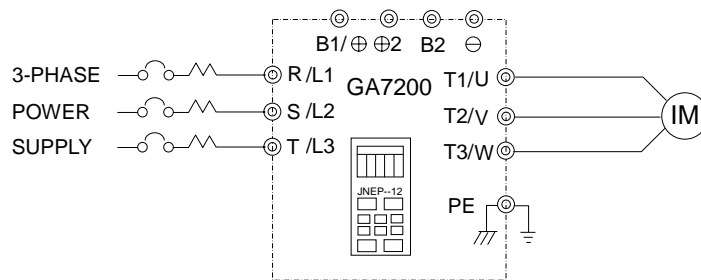

- 25 HP (18.5kW, 34kVA) or larger

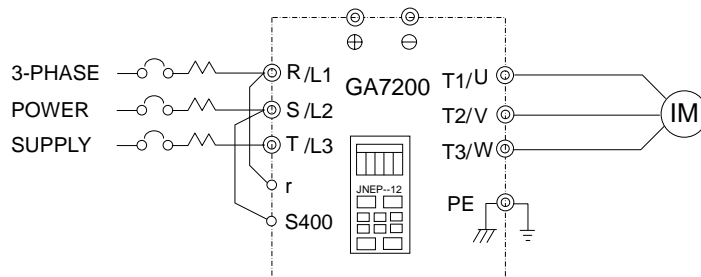



## 4.2 TERMINAL FUNCTIONS

### ■ MAIN CIRCUIT

VOLTAGE	230V CLASS				460V CLASS			
Rating Terminal	1~10HP	15~20HP	25~30HP	40~100HP	1~10HP	15~20HP	25~60HP	75~400HP
R(L1)	Circuit input power supply							
S(L2)								
T(L3)								
U(T1)	Inverter output							
V(T2)								
W(T3)								
B1/φ	● B1/φ,B2: braking resistor	● B1/φ, B2: braking resistor	-	-	● B1/φ,B2: braking resistor	● B1/φ,B2: braking resistor	-	-
B2								
⊖	● B1/φ,⊖: DC power supply	● B1/φ, φ 2:optional DCL	● φ1, ⊖: DC power supply or Braking Unit	φ, ⊖: DC power supply or Braking Unit	● B1/φ,⊖: DC power supply	● B1/φ, φ 2:optional DCL	● φ1, ⊖: DC power supply or Braking Unit	● φ, ⊖: DC power supply or Braking Unit
φ1, φ								
φ2	-	● B1/φ,⊖: DC power supply	● φ2,φ3: DCL	-	-	● B1/φ,⊖: DC power supply	● φ2,φ3: DCL	
φ3	-	-			-	-		
s	-		● r-s: cooling fan power supply	● r-s: cooling fan power supply	-		● r-s: cooling fan power supply	● r-s400: cooling fan power supply
r								
s400								
PE (⊕)	Grounding							

## ■ CONTROL CIRCUIT

Classification	Terminal	Signal Function	Description		Signal Level
Sequence Output Signal	1	Forward operation-stop signal	Forward run at closed, stop at open		Photo-coupler insulation input +24V DC 8mA
	2	Reverse operation-stop signal	Reverse run at closed, stop at open		
	3	External fault input	Fault at closed, normal state at open		
	4	Fault reset input	Reset at closed		
	5	Master/Aux. Multi-step speed ref. 1	Auxiliary freq. ref. at "closed"	Multi-function contact input: the following signals are available to select. Forward/reverse select, run mode select, multi-speed select, jog frequency select, accel/decel time select, external fault, external base clock stop, hold command, aux. input effective, speed search, energy-saving operation.	
	6	Multi-step speed ref. 2	Effective at "closed"		
	7	Jog command	Jog run at "closed"		
	8	External coast to stop	Inv. output stop at "closed"		
11	Sequence common	-			
Analog Input Signal	15	Power supply terminal for speed reference	Speed reference power supply		+15V (Allowable current 20mA max.)
	13	Master speed frequency reference	0 to +10V/100% freq.		0 to +10V (20kΩ)
	14		4 to 20mA/100% freq.		4 to 20mA (250Ω)
	16	Aux. frequency reference	0-10V/100%	Multi-function contact input: one of the following signals are available to select. Speed command, speed gain, speed bias, over torque, over voltage bias, rate of accel/decel, DB current.	0 to +10V (10kΩ)
	17	Common terminal for control circuit	0		-
	12	Shield connection	-		-
Sequence Output Signal	9	During running (NO)	Run at "closed"	Multi-function contact input: one of the following signals available to output. Output during running, zero speed, synchronized speed, arbitrary speed agreed, frequency detection, overtorque, undervoltage, run mode, coast to stop, braking resistor overheat..	Dry contact Contact capacity: 250V AC 1A or less 30VDC 1A or less
	10				
	25	Zero speed detection	Occurs at minimum freq. (Cn-07) or less		
	26	Speed agreed detection	Occurs when the frequency reaches $\pm 1\%$ of set freq.	Open collector output +48V 50mA or less	
	27	Open collector output common		-	
	18	Fault contact output common (NO, NC)	Fault at closed between terminals 18 and 20 Fault at open between terminals 19 and 20		Dry contact Contact capacity: 250VAC 1A or less 30VDC 1A or less
	19				
20					
Analog Output Signal	21	Frequency meter output	0 to 10V/100% freq.	Ammeter/voltmeter/wattmeter output selection available	0 to 11V max. 2mA or less
	22	Common			

## 5. DIGITAL OPERATOR PROGRAMMING

The following is an operation example for the digital operator keypad.

### PRECAUTION

#### Before Power ON

- For the 460V class, 25HP (18.5kW, 34kVA) or larger inverter, change the supply voltage selection tap of control transformer to the same tap as input voltage. Refer to Installation Manual.

#### Before Operation





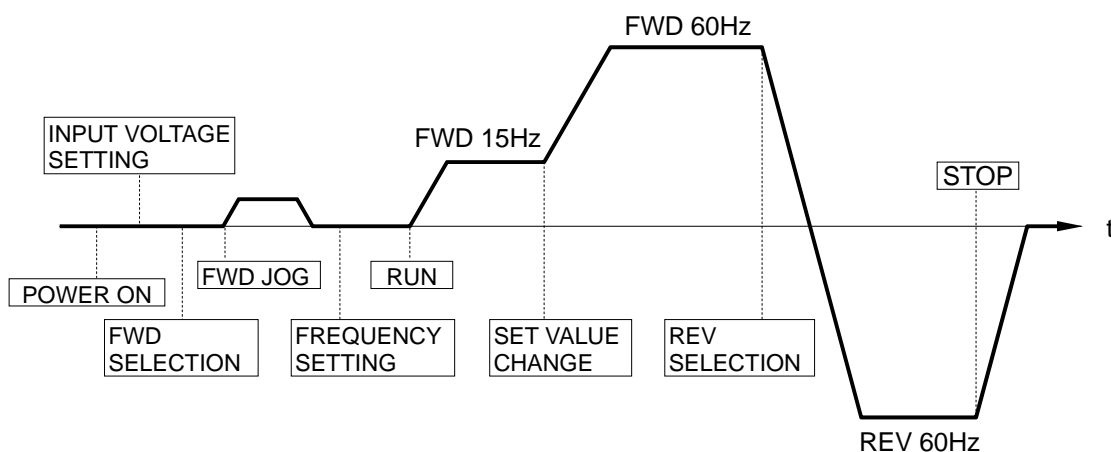





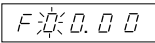
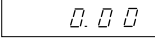
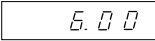

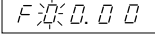
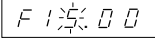
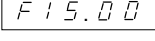
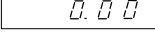

- Be sure to set input voltage in control constant Cn-01. The initial value is 220 for 230V class, 440 for 460V class.

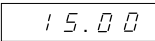
### ■ Operation Pattern

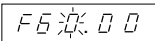
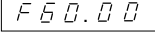
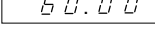
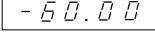

### ■ Typical Operation

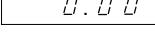
Description	Keypad Operation	Digital Operator Display	Remarks
<sup>①</sup> Turn on power supply • Frequency reference value is displayed. • Select PRGM mode.	<b>PRGM</b> <b>DRIVE</b>		LED <b>DRIVE</b> OFF
<sup>②</sup> Set input voltage power supply • Select control constant (Cn-□□) (ex. 220V) • Display Cn-01 data. • Set 220V as input voltage.	<b>DSPL</b> Depress three times. <b>DATA ENTER</b>  <b>DATA ENTER</b>	   	Displayed for 0.5 second. Confirm the display.
Cont'd			

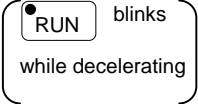
Description	Keypad Operation	Digital Operator Display	Remarks
Cont'd			
3 <b>FWD JOG</b> <ul style="list-style-type: none"> <li>Select DRIVE mode.</li> <li>Select output frequency monitor display.</li> <li>Select rotating direction. (FWD is default at power ON.)</li> <li>Jog operation.</li> </ul>	<b>PRGM DRIVE</b> <b>DSPL</b>  <b>JOG</b>	   	LED <b>DRIVE</b> lights.  LED <b>FWD</b> lights.
4 <b>Frequency Setting</b> 15Hz <ul style="list-style-type: none"> <li>Frequency reference value display is selected.</li> <li>Change reference value.</li> <li>Set value is written in.</li> <li>Select output frequency monitor display.</li> </ul>	<b>DSPL</b> Depress Six times.     <b>DATA ENTER</b> <b>DSPL</b>	    	Stops blinking for two seconds.
5 <b>FWD RUN</b> <ul style="list-style-type: none"> <li>Running operation.</li> </ul>			LED  lights.
6 <b>Change frequency reference value</b> 60Hz <ul style="list-style-type: none"> <li>Select frequency reference value display.</li> <li>Change reference value.</li> <li>Set value is written in.</li> <li>Select output frequency monitor value.</li> </ul>	<b>DSPL</b>     <b>DATA ENTER</b> <b>DSPL</b>	  	Stops blinking for two seconds.
7 <b>REV RUN</b> <ul style="list-style-type: none"> <li>Switch to reverse run.</li> </ul>	<b>FWD REV</b>		LED <b>REV</b> lights.
8 <b>STOP</b> <ul style="list-style-type: none"> <li>Decelerate to a stop.</li> </ul>			LED  lights.  

## 6. PROGRAM MODE SETTING AND CHANGE

The following shows an example of main functions and characteristics.

### 6.1 V/f PATTERN SETTING **Sn-02**













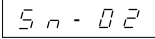

16 types of V/f patterns are available according to motor type, load characteristics and operating conditions.

#### PRECAUTION

- To select V/f pattern, set the inverter input voltage to Cn-01.
- For details on the different V/f patterns, refer to Par. 7.3 SYSTEM CONSTANTS "V/f PATTERN SELECTION" on page 66 and 67.



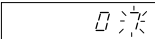

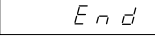





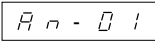

#### ■■ FIXED V/f PATTERN SELECTION

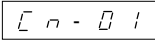
(Example) Change to variable torque characteristics (Set "7".)

Description	Keypad Operation	Digital Operator Display	Remarks
<ul style="list-style-type: none"> <li>• Select PRGM mode.</li> </ul>			LED  OFF
<ul style="list-style-type: none"> <li>• Select Sn-02.</li> </ul>	 Depress twice.  		
<ul style="list-style-type: none"> <li>• Constant display value is displayed.</li> </ul>			
<ul style="list-style-type: none"> <li>• Set or change constant.</li> </ul>	  		
<ul style="list-style-type: none"> <li>• Constant value is written in.</li> </ul>			Displayed for 0.5 second. Confirm the display for each constant.



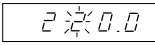

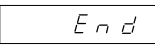





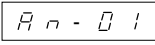



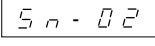

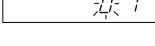



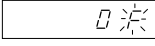

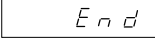



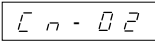

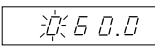



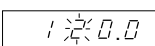

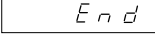



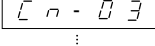

## ■ INPUT VOLTAGE SETTING

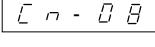
(Example) Set input voltage to 220V.

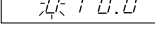
Description	Keypad Operation	Digital Operator Display	Remarks
<ul style="list-style-type: none"> <li>Select PRGM mode.</li> </ul>			LED  OFF
<ul style="list-style-type: none"> <li>Select Cn-01.</li> </ul>	 Depress three times.  		
<ul style="list-style-type: none"> <li>Constant set value is displayed.</li> </ul>			
<ul style="list-style-type: none"> <li>Set or change constant.</li> </ul>	  		
<ul style="list-style-type: none"> <li>Constant value is written in.</li> </ul>			Displayed for 0.5 second. Confirm the display for each constant.

## ■ ARBITRARY V/f SETTING (Sn-02, Cn-02 to -08)

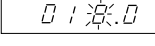
(Example) Change to “ $F_{\max} = 120\text{Hz}$ ,  $V_{\min} = 18\text{V}$ ”.

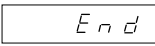
Description	Keypad Operation	Digital Operator Display	Remarks
<ul style="list-style-type: none"> <li>Select PRGM mode.</li> </ul>			LED  OFF
<ul style="list-style-type: none"> <li>Select Sn-02.</li> </ul>	 Depress twice.  		
<ul style="list-style-type: none"> <li>Constant set value is displayed.</li> </ul>			
<ul style="list-style-type: none"> <li>Set or change constant. Set to “F”.</li> </ul>	  		
<ul style="list-style-type: none"> <li>Constant is written in.</li> </ul>			
<ul style="list-style-type: none"> <li>Select Cn-02.</li> </ul>	  		Refer to the next page
<ul style="list-style-type: none"> <li>Constant set value is displayed.</li> </ul>			
<ul style="list-style-type: none"> <li>Set or change constant.</li> </ul>	  		
<ul style="list-style-type: none"> <li>Constant value is written in.</li> </ul>			
<ul style="list-style-type: none"> <li>Select Cn-02.</li> </ul>	  		
<ul style="list-style-type: none"> <li>.....</li> </ul>	<ul style="list-style-type: none"> <li>.....</li> </ul>	<ul style="list-style-type: none"> <li>.....</li> </ul>	
<ul style="list-style-type: none"> <li>Select Cn-08</li> </ul>	  		
<ul style="list-style-type: none"> <li>Constant set value is displayed.</li> </ul>			
<ul style="list-style-type: none"> <li>Set or change constant.</li> </ul>	  		
<ul style="list-style-type: none"> <li>Constant value is written in.</li> </ul>			

- Set Sn-02 to F.

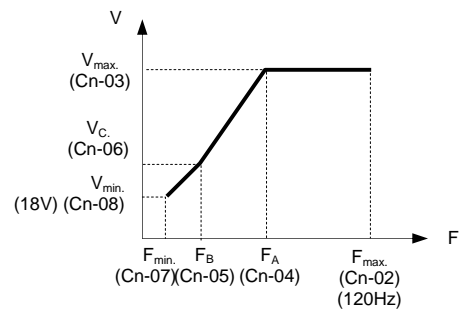

- If  $F_{MAX.} \geq F_A > F_B \geq F_{MIN.}$  is not satisfied, a setting error occurs.
- When V/f pattern is selected to be linear, set the same value for Cn-07 and Cn-05. (Cn-06 setting is disregarded). Refer to pages 67, 68 and 69 for V/f pattern selection.



## 6.2 ACCEL/DECEL TIME SETTING **bn-01 to -04 (Sn-06, Sn-15 to -18)**

Accel/decel time can be changed in DRIVE mode during running.

- Acceleration and deceleration time each has two set values. When “ accel/decel time change” is selected (7 is set in Sn-15, Sn-16, Sn-17 or Sn-18) as a multi-function terminal function, the values set in bn-03 and-04 become effective.
- S-curve characteristics of soft start can be selected in the 1-and 2-digits of Sn-06.

(Example) When S-curve not used, accel and decel times are set with bn-01 through bn-04.





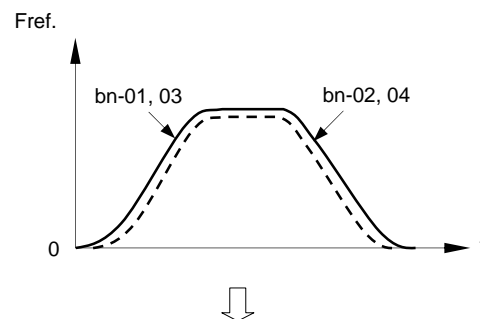



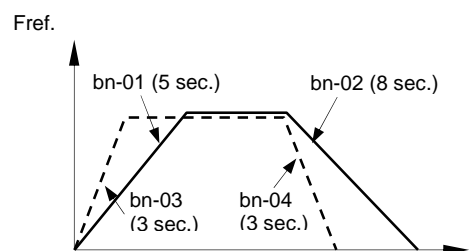

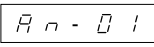





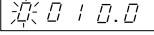



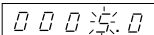

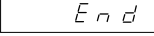





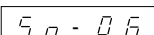





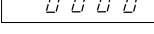



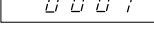

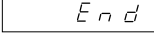

	bn-□ □	Set Value
Accel Time 1	(bn-01)	5 seconds
Decel Time 1	(bn-02)	8 seconds
Accel Time 2	(bn-03)	3 seconds
Decel Time 2	(bn-04)	3 seconds

Factory setting  
 (S-curve characteristics: provided)  
 bn-01 to 04: 10 seconds

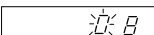

Setting change  
 (S-curve characteristics: not provided)

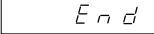

Description	Keypad Operation	Digital Operator Display	Remarks
<ul style="list-style-type: none"> <li>Select PRGM mode.</li> </ul>			LED  OFF
<ul style="list-style-type: none"> <li>Select bn-01.</li> </ul>	  		
<ul style="list-style-type: none"> <li>Constant set value is displayed.</li> </ul>			
<ul style="list-style-type: none"> <li>Set or change constant.</li> </ul>	  		
<ul style="list-style-type: none"> <li>Constant value is written in.</li> </ul>			Displayed for 0.5 second. Confirm the display for each constant.
<ul style="list-style-type: none"> <li>Select bn-02.</li> </ul>	  		
<ul style="list-style-type: none"> <li>...</li> </ul>			
<ul style="list-style-type: none"> <li>Select Sn-06.</li> </ul>	  		
<ul style="list-style-type: none"> <li>Constant set value is displayed.</li> </ul>			Refer to the next page
<ul style="list-style-type: none"> <li>Set or change constant.</li> </ul>	  		
<ul style="list-style-type: none"> <li>Constant value is written in.</li> </ul>			Displayed for 0.5 second. Confirm the display for each constant.
<ul style="list-style-type: none"> <li>Select Sn-18.</li> </ul>	  		
<ul style="list-style-type: none"> <li>Constant set value is displayed.</li> </ul>			
<ul style="list-style-type: none"> <li>Set or change constant.</li> </ul>	  		
<ul style="list-style-type: none"> <li>Constant value is written in.</li> </ul>			Displayed for 0.5 second. Confirm the display for each constant.

## 6.2 ACCEL/DECEL TIME SETTING bn-01 to -04 (Sn-06, Sn-15 to -18) (Cont'd)

\* Input signal selection

Sn-06 Operation mode selection 3

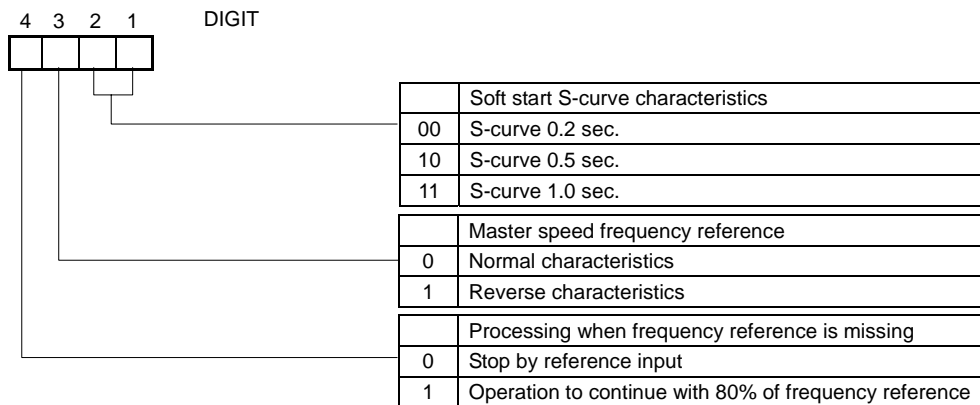













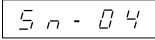

### Application Example

Machine requires soft start at acceleration and soft stop at deceleration.

## 6.3 INPUT SIGNAL SELECTION **Sn-04**

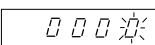
(Example) Change from operator control to terminal control of run/stop and frequency reference.

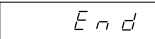
Description	Keypad Operation	Digital Operator Display	Remarks
<ul style="list-style-type: none"> <li>Select PRGM mode.</li> </ul>			LED  OFF
<ul style="list-style-type: none"> <li>Select Sn-04.</li> </ul>	  		
<ul style="list-style-type: none"> <li>Constant display value is displayed.</li> </ul>			<ul style="list-style-type: none"> <li>Refer to the diagram shown below.</li> </ul>
<ul style="list-style-type: none"> <li>Set or change constant.</li> </ul>	  		
<ul style="list-style-type: none"> <li>Constant value is written in.</li> </ul>			Displayed for 0.5 second. Confirm the display for each constant.

\* Input signal selection **Sn-04**



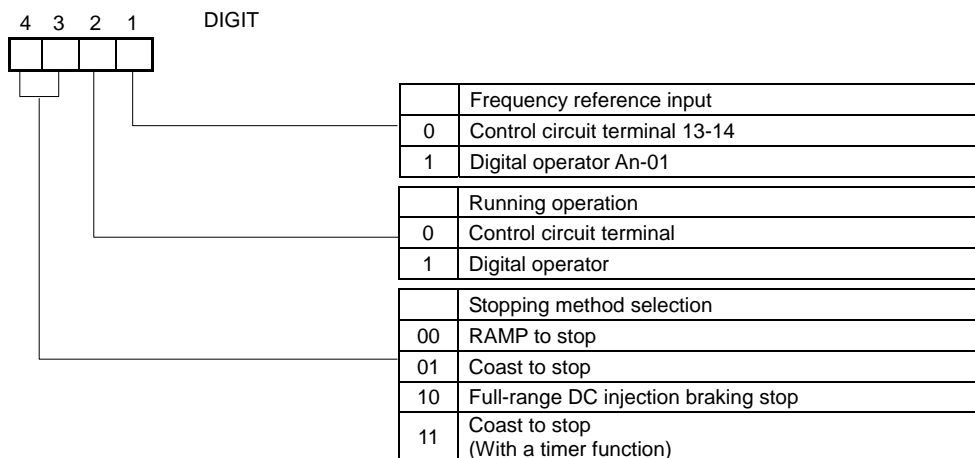







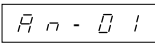



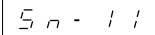

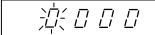



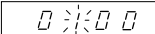

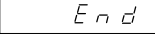

**Sn-04 Operation mode selection**

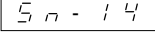

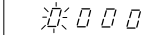
## 6.4 PROTECTIVE CHARACTERISTICS SELECTION **Sn-10 to -14**

Protective characteristics can be selected by Sn-10, Sn-11, Sn-12 and Sn-14.

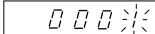
(Example) Operation is continued after recovery from momentary power loss and the electronic thermal protection is turned OFF.

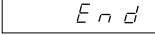
Description	Keypad Operation	Digital Operator Display	Remarks
<ul style="list-style-type: none"> <li>Select PRGM mode.</li> </ul>			LED  OFF
<ul style="list-style-type: none"> <li>Select Sn-11.</li> </ul>	  		
<ul style="list-style-type: none"> <li>Constant set value is displayed.</li> </ul>			<ul style="list-style-type: none"> <li>Refer to pages 29 and 30.</li> </ul>
<ul style="list-style-type: none"> <li>Set or change constant.</li> </ul>	  		
<ul style="list-style-type: none"> <li>Constant value is written in.</li> </ul>			Displayed for 0.5 second. Confirm the display for each constant.
	  		
<ul style="list-style-type: none"> <li>Constant set value is displayed.</li> </ul>			
<ul style="list-style-type: none"> <li>Set or change constant.</li> </ul>	  		
<ul style="list-style-type: none"> <li>Constant value is written in.</li> </ul>			Displayed for 0.5 second. Confirm the display for each constant.

\* Protective characteristics

**Sn-10 Protective characteristic 1 (stall prevention)**

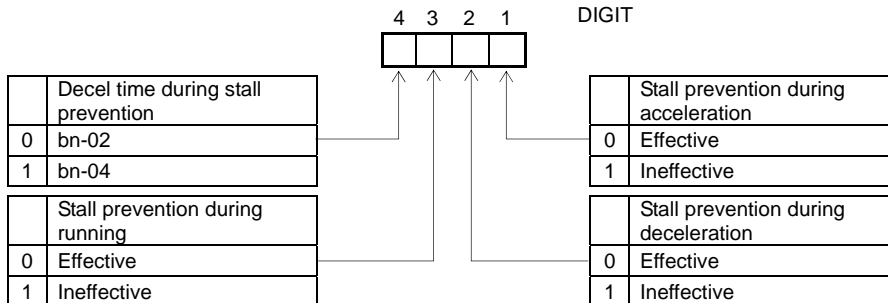

**Sn-11 Protective characteristic 2 (Momentary power loss ride-thru)**

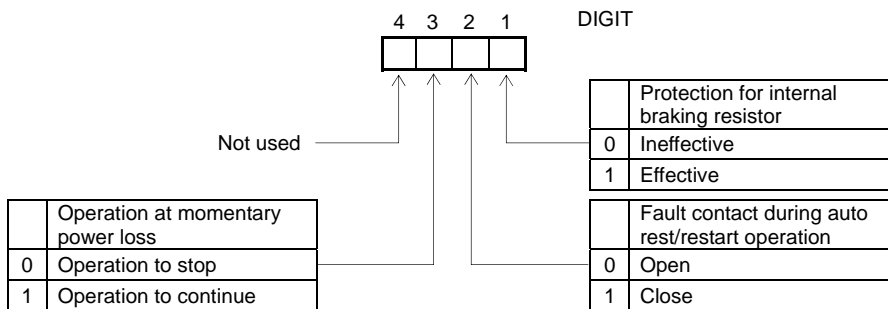

**Sn-12 Protective characteristic 3 (External fault terminal 3)**

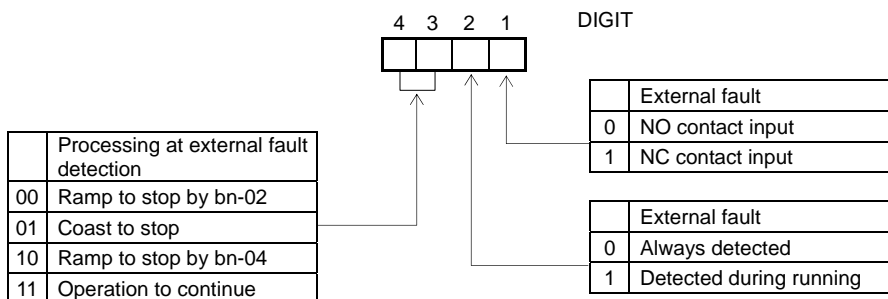

6.4 PROTECTIVE CHARACTERISTICS SELECTION **Sn-10 to -14** (Cont'd)

**Sn-13 Protective characteristic 4 (Fan fault protection)**

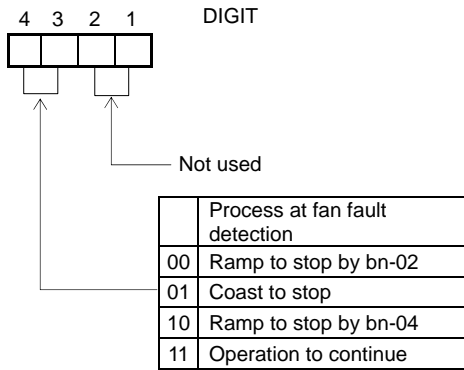

**Sn-14 Protective characteristic 5 (Motor protection)**

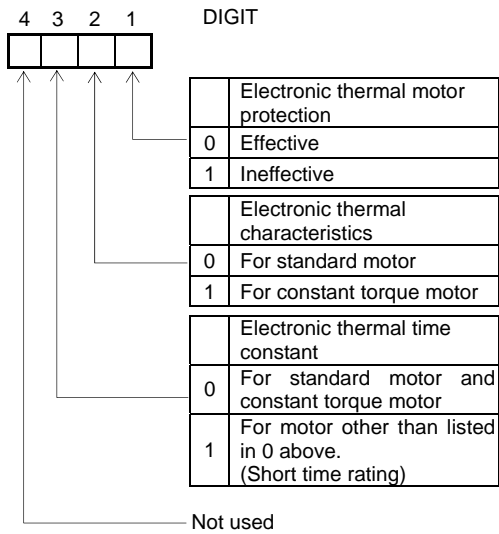

## 6.5 MULTI-FUNCTION INPUT SELECTION Sn-04, Sn-15 to -19, bn-09

Response to constant input is selected by the setting of Sn-15 to -19.

(Example 1) 2-step speed operation by analog reference. (Set Sn-04 to 0000)

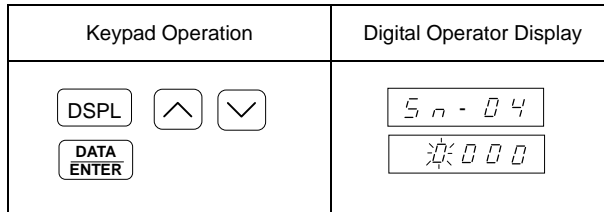

Constant Setting				
Terminal	Sn-	Set Value	Factory Setting	Name
5	15	3	3	Multi-step speed reference 1
6	16	4	4	Multi-step speed reference 2
7	17	6	6	Jog frequency *
8	18	8	8	External baseblock command
16	19	0	0	Auxiliary frequency

\* If jog frequency reference and multi-step speed reference (1, 2) are turned ON simultaneously, jog frequency reference has priority.

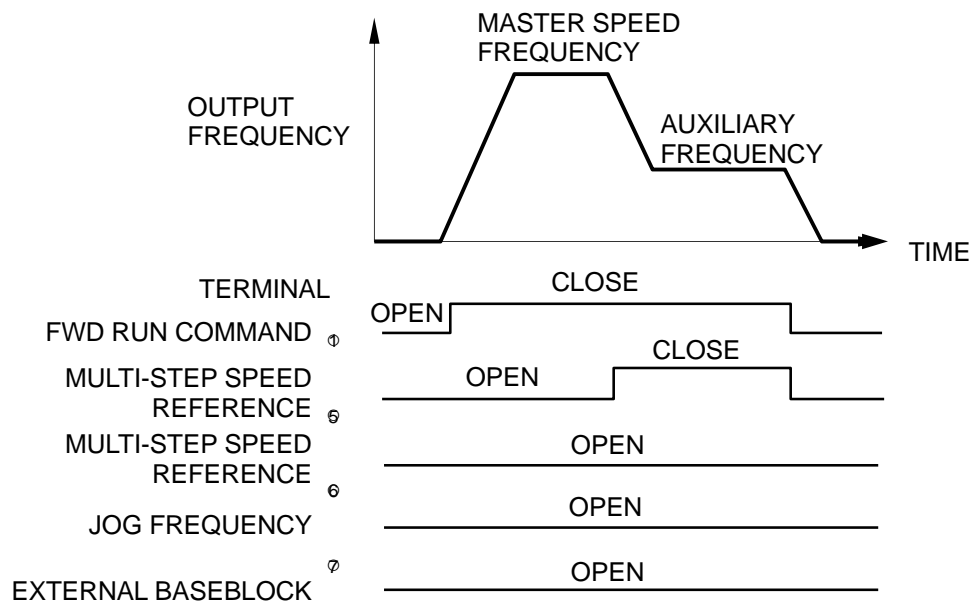



## 6.5 MULTI-FUNCTION INPUT SELECTION Sn-04, Sn-15 to -19, bn-09 (Cont'd)

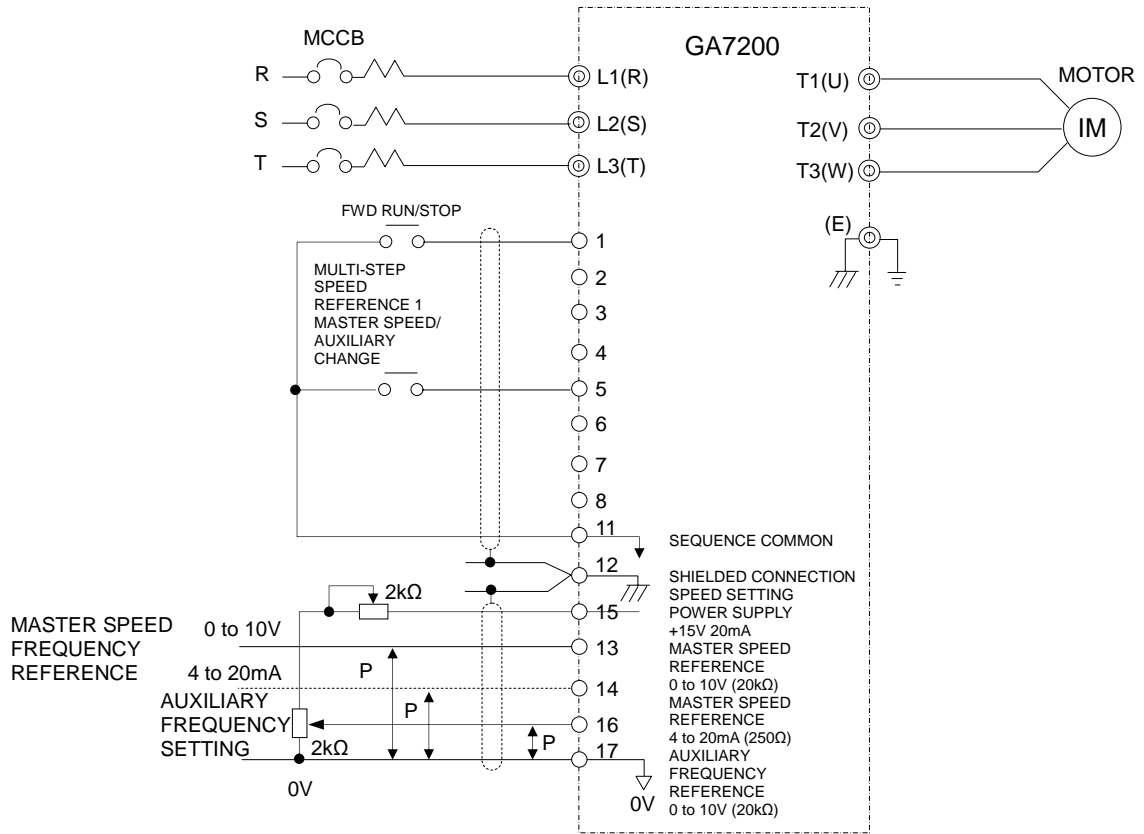

(Example 2) 5-step speed operation + energy-saving operation  
(terminal 8)

Keypad Operation	Digital Operator Display	Remarks
DSPL    ^    v DATA ENTER >    ^    v RESET DATA ENTER Only check set value { DSPL    ^    v DATA ENTER	5 n - 1 8 5 8 6 8 E n d 6 n - 0 9 5 8 0	Displayed for 0.5 second. Confirm the display for each constant.

The following shows a sequence to perform 5-step speed operation.

Constant Setting				
Terminal	Sn-	Set Value	Factory Setting	Name
5	1	3	3	Multi-step speed reference 1 *
6	16	4	4	Multi-step speed reference 2 +
7	17	6	6	Jog frequency **
8	18	63	8	Energy-saving operation

\* For combination of multi-step speed operations, refer to pages 84 and 85.

+For frequency reference, set in the form of An-□ □.

\*\*Jog reference has priority over multi-step speed reference (1,2) when they are turned ON simultaneously.

6.5 MULTI-FUNCTION INPUT SELECTION **Sn-04, Sn-15 to -19, bn-09** (Cont'd)

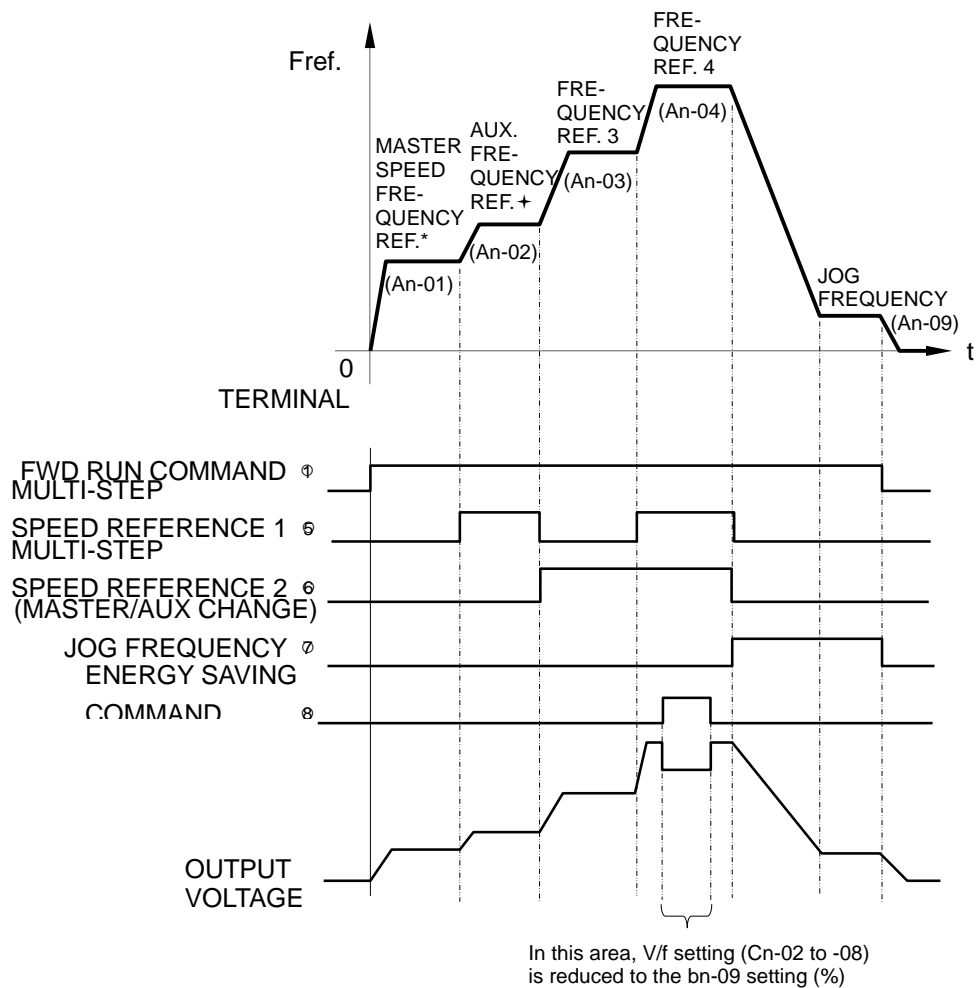

- \* When Sn-04 is set to x x x 1, that value will be the internal set value (An-01).
- + When Sn-19 is set with any value other than 00, An-02 will be effective. When multi-function analog reference input is not used, set 0F as the set value.

(Example 3) 9-step speed operation

Keypad Operation	Digital Operator Display	Remarks
DSPL    ^    v DATA ENTER >    ^    v RESET DATA ENTER	Sn - 1 7 0.6 0.6 End	Displayed for 0.5 second. Confirm the display for each constant.
DSPL    ^    v DATA ENTER >    ^    v RESET DATA ENTER	Sn - 1 8 0.8 0.8 End	

Constant Setting				
Terminal	Sn-	Set Value	Factory Setting	Name
5	15	3	3	Multi-step speed reference 1 *
6	16	4	4	Multi-step speed reference 2 +
7	17	6	6	Multi-step speed reference 3
8	18	63	8	Jog frequency **

\* For combination of multi-step speed operations, refer to pages 84 and 85.

+For frequency reference, set in the form of An-□□.

\*\*Jog reference has priority over multi-step speed reference (1 to 3) when they are turned ON simultaneously.

## 6.5 MULTI-FUNCTION INPUT SELECTION Sn-04, Sn-15 to -19, bn-09 (Cont'd)

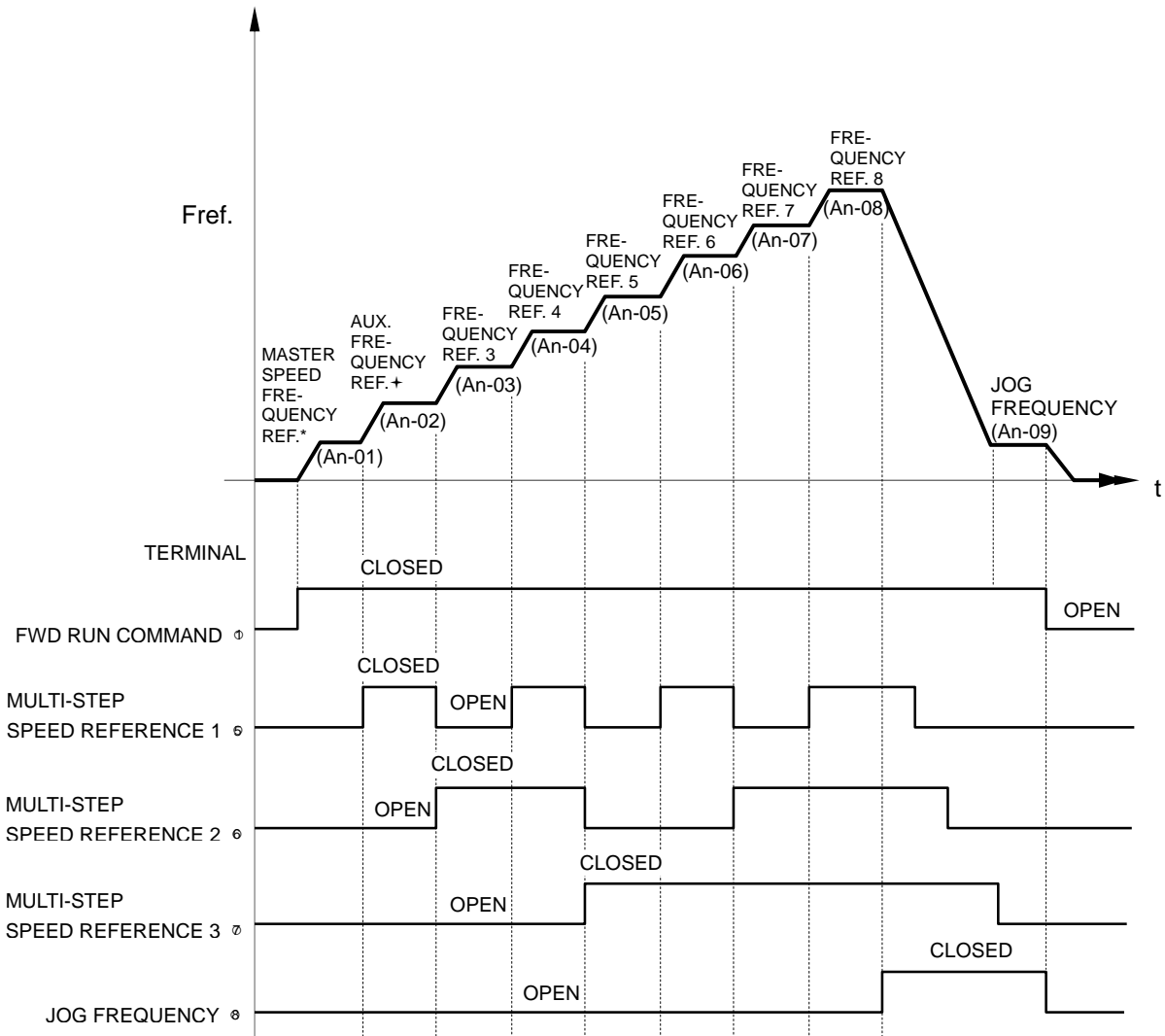

\* When Sn-04 is set to x x x 1, that value will be the internal set value (An-01).

+ When Sn-19 is set with any value other than 00, An-02 will be effective. When multi-function analog reference input is not used, set 0F as the set value.

## 6.6 CONTACT OUTPUT SELECTION **Sn-20**

Contact output function can be selected by the setting of Sn-20.

**(Example) Overtorque signal is read out from contact output.**

- Applicable inverter: 230V, 10HP (rated current 32A)
- Applicable motor : 10HP (7.5kW), 4P (motor rated current 26.8A)  
(TECO MOTOR)

Overtorque detection level is equivalent to motor rated torque. Set a mode in which overtorque signal is output only when overtorque is detected during constant speed running. Inverter rated current is regarded as 100% value.

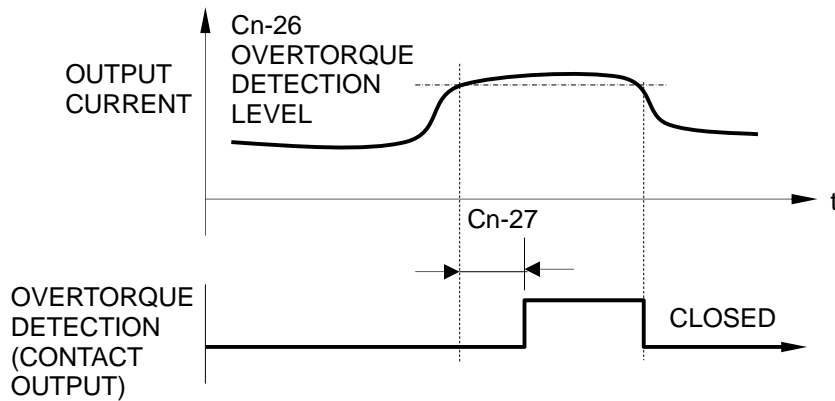

## 6.6 CONTACT OUTPUT SELECTION Sn-20 (Cont'd)

Keypad Operation	Digital Operator Display	Remarks
DSPL    ^    v DATA ENTER >    ^    v <small>RESET</small> DATA ENTER	Sn-07 0.00 0001 End	Displayed for 0.5 second. Confirm the display for each constant.
DSPL    ^    v DATA ENTER >    ^    v <small>RESET</small> DATA ENTER	Sn-20 0.0 0.0 End	
DSPL    ^    v DATA ENTER >    ^    v <small>RESET</small> DATA ENTER	Cn-26 26.0 0.0 End	$\frac{26.8A}{32A} \times 100\%$ =84% Displayed for 0.5 second. Confirm the display for each constant.
DSPL    ^    v DATA ENTER	Cn-27 0.1	

### Application Example

As with an extruder, a cutter, or other machines, when a load is applied beyond a given set value, the machines (particularly cutting tools) should be protected.

## 6.7 FREQUENCY REFERENCE CHANGE bn-05, -06

Any output frequency value for frequency set value (0 to 10V or 4 to 20mA) can be set.

(Example)

Adjust to 10% speed (6Hz) at frequency reference input 4mA and 100% speed at 16.8mA (Set bn-05 = 0122.5 and bn-06 = +010).

Keypad Operation	Digital Operator Display	Remarks
DSPL    ^    v DATA ENTER >    ^    v RESET    ^    v DATA ENTER	bn-05 100.0 0122.5 <sup>1</sup> End	Displayed for 0.5 second. Confirm the display for each constant.
DSPL    ^    v DATA ENTER >    ^    v RESET    ^    v DATA ENTER	bn-06 000 <sup>2</sup> 001 End	Displayed for 0.5 second. Confirm the display for each constant.



## 6.7 FREQUENCY REFERENCE CHANGE bn-05, -06 (Cont'd)

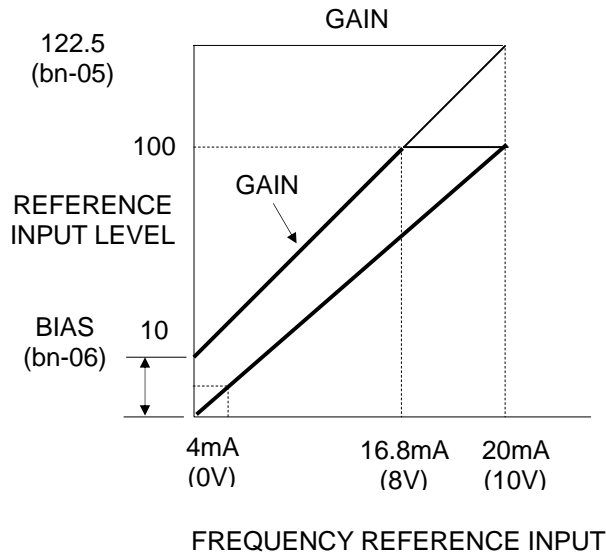

Note: Frequency reference gain (bn-05) and frequency reference bias (bn-06) can be changed while running in DRIVE mode.

\*1 How to calculate gain

$$X = \frac{100 - b}{a} \dots (1) \quad G = X + b \dots (2)$$

X is obtained from equation (1)

$$X = \frac{100 - 10}{0.8} = 112.5$$

G is obtained by substituting X obtained in equation (1) to equation (2).

$$G = 112.5 + 10 = 122.5$$

a: Reference input ratio at 100% frequency. Since it is 100% speed (60 Hz) at 16.8mA in this example, the following equation is established.

$$\frac{16.8\text{mA} - 4\text{mA}}{20\text{mA} - 4\text{mA}} = 0.8a = 0.8$$

b: Bias level (%)

Since it is 10% (6Hz) at frequency reference input 4mA in this example, the following equation is established.

$$b = 10$$

G: Gain set value

122.5 in this example

\*2  $\square$  in the uppermost digit indicates “+ (plus).”

- is displayed when it is “(- minus).”

### Application Example

For instrumentation input of 4 to 20mA, the amount should be adjusted at startup. Maximum frequency should be adjusted.

## 6.8 DC INJECTION BRAKING (DC) Cn-10 to -13

DC injection braking at starting or stopping function is selected by the setting of Cn-10 to -13.

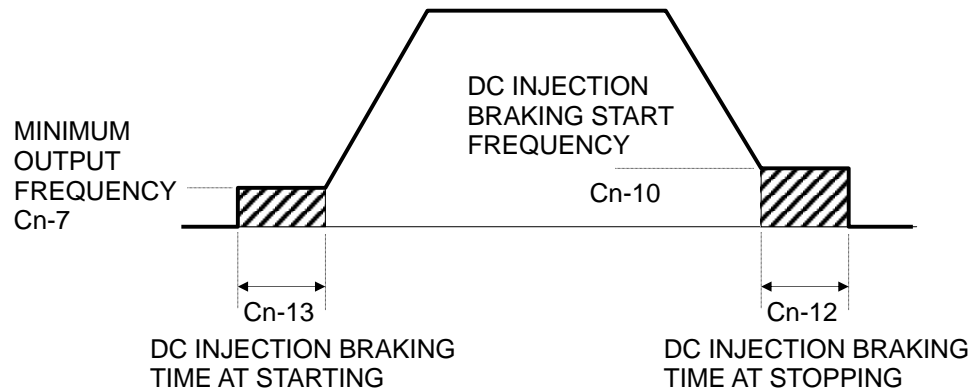

Time Chart of DC injection braking time at starting.

(Example) Set 3 seconds to DC injection braking time at starting.

Keypad Operation	Digital Operator Display	Remarks
DSPL    ^    v DATA ENTER >    ^    v RESET    ^    v DATA ENTER	C n - 1 3 0 0 . 0 0 0 0 E n d	Displayed for 0.5 second. Confirm the display for each constant.

### Application Example

When an idle fan slips and the direction of rotation is indefinite, "OC" and "OV" trip should be avoided.

## 6.9 FULL-RANGE DC INJECTION BRAKING STOP (DCB STOP)

**Sn-04 = 10XX, Cn-12**

When the full-range DC injection braking stop function is used, the inverter can be stopped without a braking resistor. When stop command is input, DC injection braking stop is executed. DC injection braking time while stopping is set by Cn-12 at 10% speed and varies according to output frequency at stop command input as shown below.

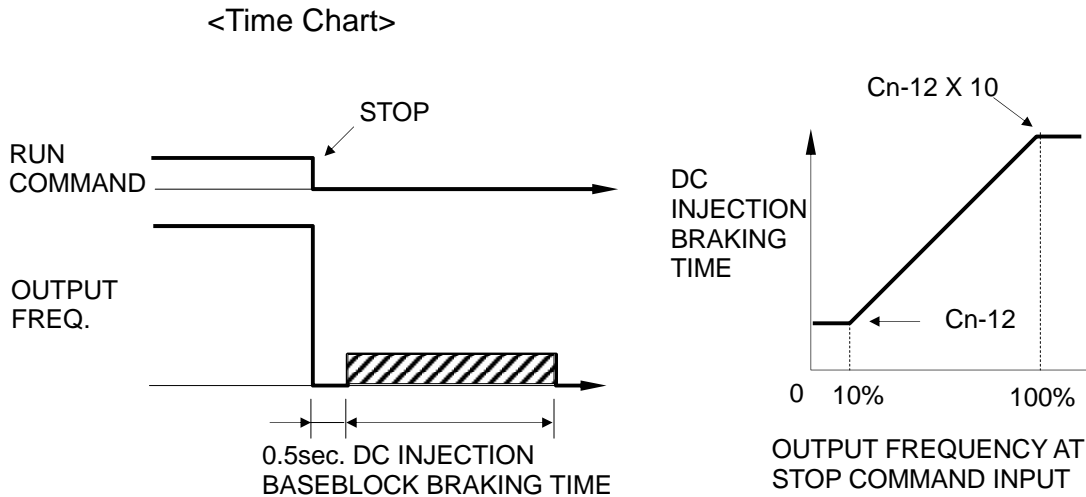

(Example)

Full-range DC injection braking stop is selected to set DC injection braking time to 1 second.

Keypad Operation	Digital Operator Display	Remarks
DSPL    ^    v DATA ENTER	Sn-04	
^    v DATA ENTER	011	
^    v DATA ENTER	011	
DSPL    ^    v DATA ENTER	End	Displayed for 0.5 second. Confirm the display for each constant.
DSPL    ^    v DATA ENTER	Cn-12	
DSPL    ^    v DATA ENTER	0.5	
>    ^    v RESET    DATA ENTER	01.0	Displayed for 0.5 second. Confirm the display for each constant.
>    ^    v RESET    DATA ENTER	End	

### Application Example

DC injection brake should be applied sparingly without a braking resistor. (Within 3 - 5% duty cycle).

## 6.10 UPPER/LOWER LIMIT OF FREQUENCY REFERENCE Cn-14 , -15

Output frequency upper/lower limit value can be set.

When the lower limit value is less than minimum output frequency, rotation continues at the lower limit value until frequency reference reaches the value, by inputting the run command.

(Example)

Set upper, lower limit of frequency reference.

Upper limit: 80% of set frequency

Lower limit: 10% of set frequency

Keypad Operation	Digital Operator Display	Remarks
DSPL    ^    v DATA ENTER	C n - 14	
>    ^    v RESET    ^    v DATA ENTER	000	
>    ^    v RESET    ^    v DATA ENTER	000	
DSPL    ^    v DATA ENTER	E n d	Displayed for 0.5 second. Confirm the display for each constant.
DSPL    ^    v DATA ENTER	C n - 15	
>    ^    v RESET    ^    v DATA ENTER	000	
>    ^    v RESET    ^    v DATA ENTER	000	
>    ^    v RESET    ^    v DATA ENTER	E n d	Displayed for 0.5 second. Confirm the display for each constant.

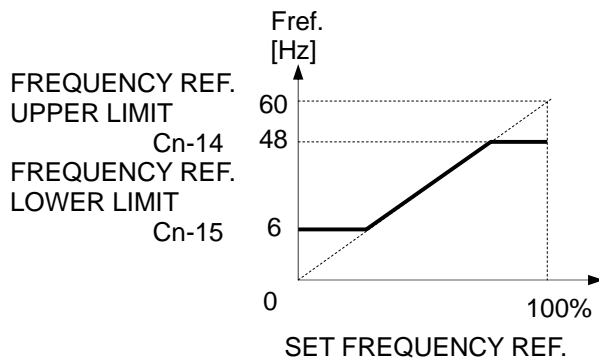

Note: Setting Cn-14 to 109% enables frequency up to  $Cn-02 \times 1.09$  to be output.

Example: Assuming  $Cn-02 = 60\text{Hz}$ ,  $Cn-14 = 109\text{Hz}$ , up to  $65.4\text{Hz}$  can be output. However, when  $400\text{Hz}$  is exceeded, the value is clamped to  $400\text{Hz}$ .

### Application Example

The maximum air quantity (upper limit) allowed and the minimum air quantity (lower limit) required should be maintained for a fan or a blower.

## 6.11 PROHIBITED (SKIP) FREQUENCY Cn-16 to -19

When an operation is required to avoid mechanical resonance frequency, the setting prohibited frequency function is effective.

Setting prohibited frequency is set in Cn-16 to -18 in units of 0.1Hz.  
Setting prohibited frequency width is set to Cn-19 in units of 0.1Hz.

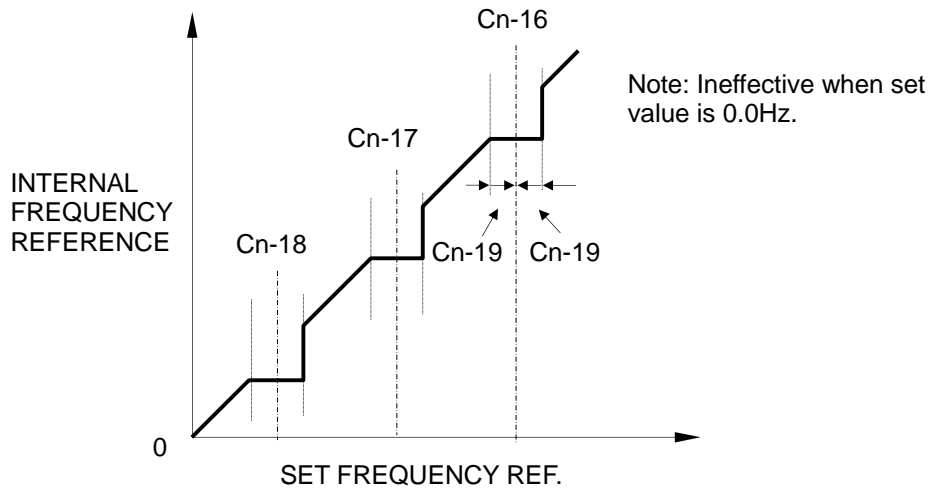

(Example) 30Hz  $\pm$  0.5Hz setting is prohibited.

Keypad Operation	Digital Operator Display	Remarks
DSPL    ^    v DATA ENTER	C n - 1 6	
	0 0 0 . 0	
>    ^    v RESET	0 0 0 . 0	
DATA ENTER	E n d	Displayed for 0.5 second. Confirm the display for each constant.
DSPL    ^    v DATA ENTER	C n - 1 9	Initial value 1.0Hz
	0 0 1 . 0	
>    ^    v RESET	0 0 0 . 0	
DATA ENTER	E n d	Displayed for 0.5 second. Confirm the display for each constant.

### Application Example

Operation avoiding mechanical resonance points in HVAC systems are required.

## 6.12 DISPLAY MODE CHANGE Cn-20

(Example)

Frequency reference An-□□ is set or read in the units of 0.01%.

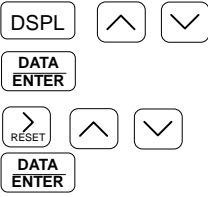
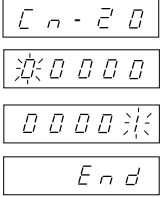
Keypad Operation	Digital Operator Display	Remarks
		<p>Displayed for 0.5 second. Confirm the display for each constant.</p>

## Operator Display Mode

Cn-20	Unit of Setting / Reading
0	Units of 0.01Hz
1	Units of 0.01%
2 to 39	Unit of r/min (0 to 39999) $r/min = 120 \times \text{frequency reference (Hz)} / \text{Cn-20}$ (Cn-20 is the number of motor poles)
40 to 39999	<p>The position of decimal point is set by the value of the 5th digit of Cn-20.</p> <p>Value of 5th digit = 0 : Displayed as xxxx</p> <p>Value of 5th digit = 1 : Displayed as xxx.x</p> <p>Value of 5th digit = 2 : Displayed as xx.xx</p> <p>Value of 5th digit = 3 : Displayed as x.xxx</p> <p>A set value of 100% frequency is determined by the 1st digit to 4th digit of Cn-20.</p> <p>Example 1 : when the set value of 100% speed is 200.0.            Cn-20 = 12000 is entered</p> <p>Example 2 : when the set value of 100% speed is 65.00.            Cn-20 = 26500 is entered</p>

## 6.13 STALL PREVENTION LEVEL WHILE RUNNING **Cn-30 (Sn-10)**

If the inverter output current exceeds Cn-30 stall prevention level for more than 100ms, the output frequency will decrease until output current is below value in Cn-30. Once current has dropped below set value in Cn-30, the inverter rated current will increase back to set value operation. Inverter rated current is regarded as 100%.

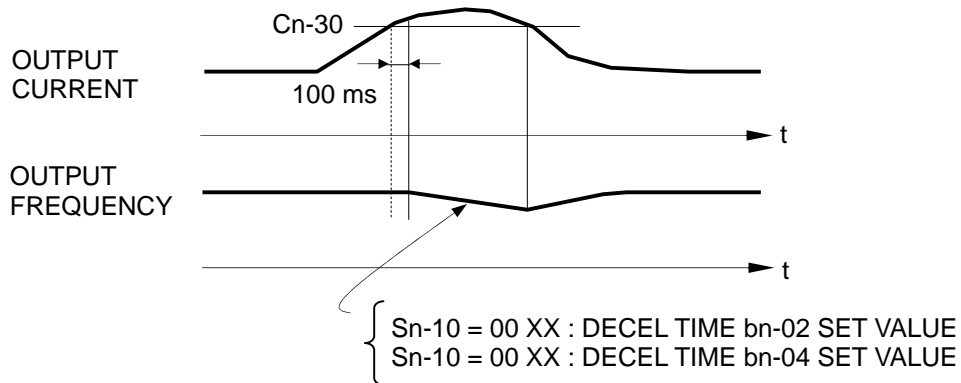

(Example) Stall prevention level while ring running 120%.  
Decel time bn-04 set value.

Keypad Operation	Digital Operator Display	Remarks
DSPL    ^    v DATA ENTER >    ^    v RESET    ^    v DATA ENTER	C n - 3 0 1 2 0 1 2 0 E n d	Displayed for 0.5 second. Confirm the display for each constant.
DSPL    ^    v DATA ENTER >    ^    v RESET    ^    v DATA ENTER	S n - 1 0 0 0 0 0 0 0 E n d	

### Application Example

Rotation speed should be automatically reduced for rated operation regardless of possible overload, and on return to normal load, the previous rotation speed should be maintained.

## 6.14 AUTO RESET/RESTART OPERATION AT FAULT (FAULT RETRY) Cn-36

If a protective function (OC, OV, OL1, OL2, OL3, OH, UV1) operates while running, auto reset/restart function can be selected. Reset/restart operation can be performed up to 10 times. By setting Cn-36 to 0, reset/restart operation at fault will not performed.

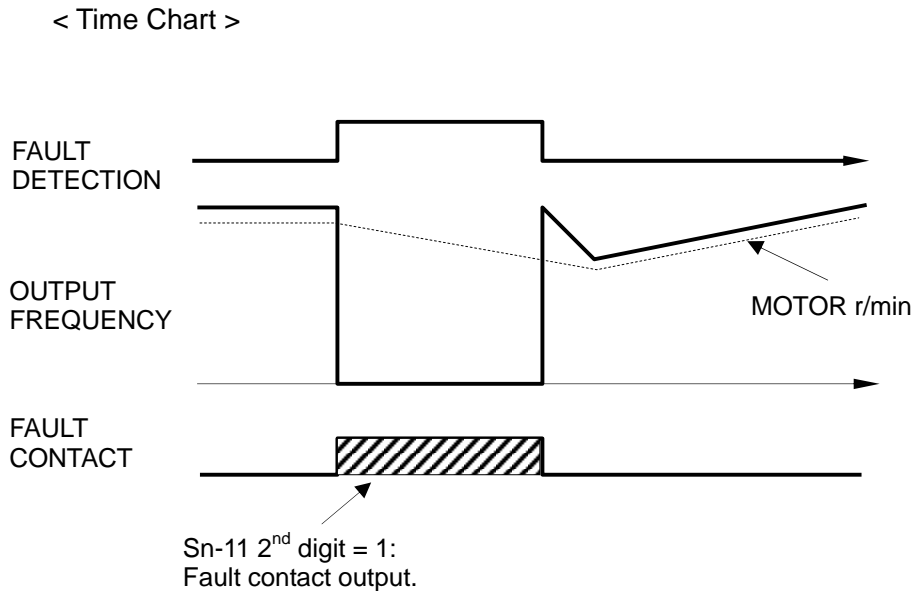

Keypad Operation	Digital Operator Display	Remarks
DSPL    ^    v DATA ENTER >    ^    v RESET DATA ENTER	Sn-11 000 0000 End	Displayed for 0.5 second. Confirm the display for each constant.
DSPL    ^    v DATA ENTER >    ^    v RESET DATA ENTER	Cn-36 0 0 End	

### Application Example

If the inverter protection function operates due to lightning surge, automatic reset will be attempted about four or five times to continue operation without stopping the motor.



## 6.15 INITIALIZING CONSTANTS Sn-03

(Example) Replacing control board.

Select inverter capacity and set V/f pattern and initialize constants.

All constants except Sn-01 (inverter capacity) and Sn-02 (V/f pattern) are initialized to the data at the factory prior to shipment.

Description	Keypad Operation	Digital Operator Display	Remarks
<div style="border: 1px solid black; padding: 2px; width: fit-content; margin-bottom: 5px;">Power ON</div> <ul style="list-style-type: none"> <li>• Frequency reference value is displayed.</li> </ul>		F  0.00	
<div style="border: 1px solid black; padding: 2px; width: fit-content; margin-bottom: 5px;">Set inverter capacity</div> <ul style="list-style-type: none"> <li>• Select PRGM mode.</li> </ul>	<b>PRGM</b> <b>DRIVE</b>	R n - 0 1	LED <b>DRIVE</b> OFF.
<div style="border: 1px solid black; padding: 2px; width: fit-content; margin-bottom: 5px;">Select 230V 15kW</div> <ul style="list-style-type: none"> <li>• Select inverter capacity constant (Sn-01).</li> <li>• Sn-01 data is displayed.</li> </ul>	DSPL Depress twice	S n - 0 1	
<ul style="list-style-type: none"> <li>• Change set value.</li> </ul>	DATA ENTER	6	
<ul style="list-style-type: none"> <li>• Set value is written in.</li> </ul>	> RESET   ^   v	0	Displayed for 0.5 second. Confirm the display for each constant.
<div style="border: 1px solid black; padding: 2px; width: fit-content; margin-bottom: 5px;">Set V/f pattern</div> <ul style="list-style-type: none"> <li>• Select V/f pattern constant (Sn-[ ][ ]).</li> </ul>	DATA ENTER	E n d	
<div style="border: 1px solid black; padding: 2px; width: fit-content; margin-bottom: 5px;">Select 60HZ stand. pattern</div> <ul style="list-style-type: none"> <li>• Select Sn-02.</li> <li>• Sn-02 data is displayed.</li> </ul>	DSPL	S n - 0 1	
<ul style="list-style-type: none"> <li>• Change set value.</li> </ul>	^   v	S n - 0 2	
<ul style="list-style-type: none"> <li>• Set value is written in.</li> </ul>	DATA ENTER	6	
	> RESET   ^   v	0	Displayed for 0.5 second. Confirm the display for each constant.
Cont'd	DATA ENTER	E n d	

## 6.15 INITIALIZING CONSTANTS Sn-03

Description	Keypad Operation	Digital Operator Display	Remarks
<p style="text-align: center;">Cont'd</p> <div style="border: 1px solid black; padding: 2px; margin-bottom: 10px;">Constant is initialized</div> <ul style="list-style-type: none"> <li>• Select initialization constant.</li> <li>• Select Sn-03.</li> <li>• Data is displayed.</li> <li>• Set to " 1110".</li> <li>• Set value is written in.</li> </ul> <div style="border: 1px solid black; padding: 5px; margin: 10px 0 10px 20px; display: inline-block;">             When <span style="border: 1px solid black; padding: 1px;">DATA ENTER</span> key is depressed, all constants except Sn-01 and Sn-02 are changed to the value set prior to shipping.         </div> <div style="border: 1px solid black; padding: 2px; margin-top: 10px;">End</div> <ul style="list-style-type: none"> <li>• Switch to DRIVE mode.</li> </ul>	<div style="border: 1px solid black; padding: 2px; margin-bottom: 10px; text-align: center;">DSPL</div> <div style="display: flex; justify-content: space-around; margin-bottom: 10px;"> <span style="border: 1px solid black; padding: 2px;">^</span> <span style="border: 1px solid black; padding: 2px;">v</span> </div> <div style="border: 1px solid black; padding: 2px; margin-bottom: 10px; text-align: center;">DATA ENTER</div> <div style="display: flex; justify-content: space-around; margin-bottom: 10px;"> <span style="border: 1px solid black; padding: 2px;">&gt; RESET</span> <span style="border: 1px solid black; padding: 2px;">^</span> <span style="border: 1px solid black; padding: 2px;">v</span> </div> <div style="border: 1px solid black; padding: 2px; margin-bottom: 10px; text-align: center;">DATA ENTER</div> <div style="border: 1px solid black; padding: 2px; margin-top: 10px; text-align: center;">PRGM DRIVE</div>	<div style="border: 1px solid black; padding: 2px; text-align: center; margin-bottom: 10px;">S n - 0 2</div> <div style="border: 1px solid black; padding: 2px; text-align: center; margin-bottom: 10px;">S n - 0 3</div> <div style="border: 1px solid black; padding: 2px; text-align: center; margin-bottom: 10px;">1 1 1 0</div> <div style="border: 1px solid black; padding: 2px; text-align: center; margin-bottom: 10px;">E n d</div> <div style="border: 1px solid black; padding: 2px; text-align: center; margin-top: 10px;">F 0 0 . 0 0</div>	<p style="text-align: center;">.</p> <p style="text-align: right;">Displayed for 0.5 second. Confirm the display for each constant.</p> <p>LED <span style="border: 1px solid black; padding: 2px;">DRIVE</span> lights.</p>

---

## 7. CONSTANTS/FUNCTION LIST

### 7.1 FREQUENCY REFERENCE **An-□□.**

These references are used during multi-speed operation. Set values of An-□□ can be changed or read during running in DRIVE mode.

#### List of An-□□ constants

An-□□	Data Name	Unit	Setting - Range	Factory Setting
01	Frequency reference 1	0.01Hz	0.00Hz to 400.00Hz	0.00Hz
02*	Frequency reference 2	0.01Hz	0.00Hz to 400.00Hz	0.00Hz
03	Frequency reference 3	0.01Hz	0.00Hz to 400.00Hz	0.00Hz
04	Frequency reference 4	0.01Hz	0.00Hz to 400.00Hz	0.00Hz
05	Frequency reference 5	0.01Hz	0.00Hz to 400.00Hz	0.00Hz
06	Frequency reference 6	0.01Hz	0.00Hz to 400.00Hz	0.00Hz
07	Frequency reference 7	0.01Hz	0.00Hz to 400.00Hz	0.00Hz
08	Frequency reference 8	0.01Hz	0.00Hz to 400.00Hz	0.00Hz
09	Jog frequency reference 9	0.01Hz	0.00Hz to 400.00Hz	6.00Hz

\*Sn-19 must be set to 1.

Note: An-□□ setting/reading units differ according to operator display mode (Cn-20) set values. The factory setting is 0.01Hz.

## 7.2 CONSTANTS CHANGE WHILE RUNNING **bn-□□.**

Set values of bn-□□ can be changed or read while running in DRIVE mode.

List of bn-□ □ constants

bn-□□	Data Name	Unit	Setting - Range	Factory Setting	
01	Acceleration time 1	0.1s	0.0 to 6000.0s	10.0s	
02*	Deceleration time 1	0.1s	0.0 to 6000.0s	10.0s	
03	Acceleration time 2	0.1s	0.0 to 6000.0s	10.0s	
04	Deceleration time 2	0.1s	0.0 to 6000.0s	10.0s	
05	Frequency reference gain	0.1%	0 to 1000.0%	100%	Sn-06 Bit 3
06	Frequency reference bias	1%	-100 to 100%	0%	
07	Torque compensation gain	0.1	0.0 to 9.9	1.0	
08	Motor rated slip	0.1%	0.0 to 9.9%+	0.0%	Cn-09 34
09	Energy-saving level gain	1%	0 to 200%	80%	
10	Monitor no. after turning ON power supply	-	1 to 3	1	
11	Analog monitor gain	0.01	0.01 to 2.55	1.00	
12	Not used	-	-	-	

## 7.2 CONSTANT CHANGE WHILE RUNNING **bn-□□ (Cont'd)**

### (1) Acceleration Time 1 (bn-01)

Acceleration time 1 is enabled when the accel/decel time change command of multi-function terminals is “open”, or the accel/decel time change function is not provided for the multifunction terminals. The acceleration time, in which frequency reference goes from 0% to 100%, is set in units of 0.1 second.

### (2) Deceleration Time 1 (bn-02)

Deceleration time 1 is enabled when the accel/decel time change command of multi-function terminals is “open”, or the accel/decel time change function is not provided for the multifunction terminals. The deceleration time, in which frequency reference goes from 100% to 0%, is set in units of 0.1 second.

### (3) Acceleration Time 2 (bn-03)

Acceleration time 2 is enabled when the accel/decel time change command of multi-function terminals is “closed”. The acceleration time, in which frequency reference goes from 0% to 100%, is set in units of 0.1 second.

### (4) Deceleration Time 2 (bn-04)

Deceleration time 2 is enabled when the accel/decel time change command of multi-function terminals is “closed”. The deceleration time, in which frequency reference goes from 100% to 0%, is set in units of 0.1 second.

### (5) Frequency Reference Gain (bn-05)

The input level when frequency reference voltage is 10V is set in units of 1%. Examples are shown below.

### (6) Frequency Reference Bias (bn-06)

The input level when frequency reference voltage is 0V is set in units of 1%.

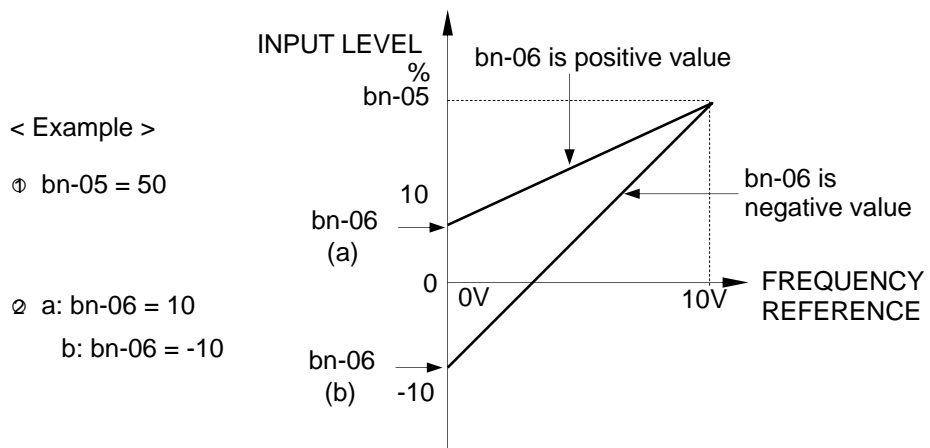

**(7) Torque Compensation Gain (bn-07)**

Torque compensation gain is set in units of 0.1.

**(8) Motor Rated Slip (bn-08)**

Motor Rated slip is set in units of 0.1%

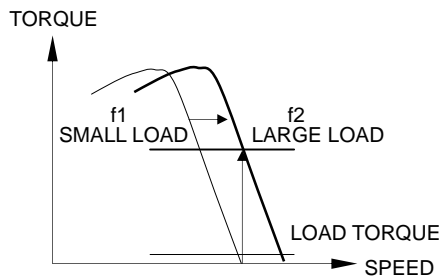

Simplified speed control is performed without encoder (PG or TG). With frequency offset  $f_1$  to  $f_2$ , speed fluctuation due to load is reduced.

When the output current of the inverter is larger than motor no-load current (Cn-34), the output frequency of the inverter is compensated.

The amount of frequency compensation is determined by the formula below. The maximum voltage frequency (Cn-04) is 100%.

If the output current is equal to the motor rated current (Cn-09), the output frequency is compensated for by the motor rated slip (bn-08).

If frequency reference is equal to or smaller than minimum output frequency (Cn-07) or motor is in a regeneration mode, slip compensation is not performed.

The amount of output frequency compensation in a constant torque area and a constant output area is shown in the figure below.

Amount of output frequency compensation =

$$\frac{\text{motor rated slip}}{\left( \frac{\text{motor rated current}}{\text{motor no-load current}} \right)} \times \left( \text{output current} - \text{motor no-load current} \right)$$

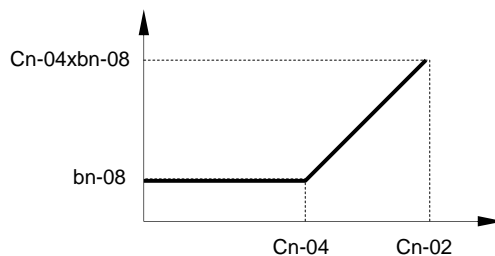

Motor rated current: Cn-09  
 Motor no-load current: Cn-34  
 Motor rated slip: bn-08

---

When 0.0 is set in bn-08, output frequency compensation is not performed.

---

## 7.2 CONSTANT CHANGE WHILE RUNNING **bn-□□** (Cont'd)

### (9) Energy-saving Level Gain (bn-09)

Energy-saving level gain is set in units of 1%.

### (10) Monitor No. after Turning ON Power Supply (bn-10)

Data to be monitored after turning ON power supply is selected with constant No. in the form of Un-□□.

① Frequency reference

② Output frequency

③ Output current

### (11) Multi-function Analog Output (bn-11)

The multi-function analog output is set in the form of  $10V \times XX$ .

<Example> When 5V is set as the 100% level, specify bn-11=0.5.

### (12) Calibrating Meter

Multi-function analog output.

When bn-11 is displayed in PRGM mode, a 100%-level voltage is output by the set value of bn-11.

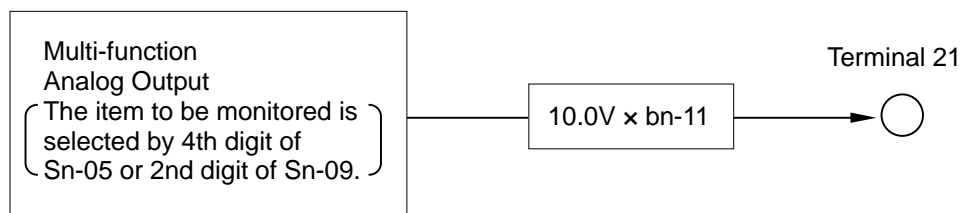

Diagram of Multi-function Analog Output



## 7.3 SYSTEM CONSTANTS

**Sn-□□**

### System Constants List (1/5)

Function	Sn- □□	Data Name	Description				Factory Setting					
							4th Digit	3rd Digit	2nd Digit	1st Digit		
Basic Setting Constant	01	Inverter Capacity	Inverter capacity selection				—*1					
	02	V/f	V/f pattern selection				01					
Operator Status	03	Display of Operator	0000	Setting and reading of An-□□, bn-□□, Sn-□□, Cn-□□ enabled				0000				
			0101	Setting and reading of An-□□ : reading of bn-□□, Sn-□□, Cn-□□ enabled								
		Constants Initialization	1110	Constants initialization (Multi-function terminals are preset prior to shipping) *2								
			1111	Constants initialization (For multi-function terminals, refer to Table of *2)								
Operation Mode Selection 1	04	Operation Method Selection			4th Digit	3rd Digit	2nd Digit	1st Digit	0011			
			Master frequency reference by analog input of control circuit terminals 13, 14	-	-	-	0					
			Master frequency reference from keypad	-	-	-	1					
			Control circuit terminal operation effective	-	-	0	-					
		Keypad operation reference effective	-	-	1	-						
		Stopping Method Selection	RAMP stop	0	0	-	-					
			Coast to stop	0	1	-	-					
			Full-range DC injection braking stop	1	0	-	-					
Coast to stop (timer function provided)	1		1	-	-							
Operation Mode Selection 2	05	Priority of Stopping	STOP key effective during operation from control terminal.	-	-	-	0	0000				
			STOP key ineffective during operation from control terminal.	-	-	-	1					
	REV RUN Prohibit	REV RUN enabled	-	-	0	-						
		REV RUN disabled	-	-	1	-						
	Control Input Scan	Control inputs are scanned twice before being accepted by MPU.	-	0	-	-						
		Control inputs are scanned once before being accepted by MPU.	-	1	-	-						

		Analog Monitor Output	Selection of item to be analog output (terminals 21,22) *3	0	-	-	-	
		Analog Monitor Output	Selection of item to be analog output (terminals 21,22) *3	1	-	-	-	

### System Constants List (2/5)

Function	Sn- □□	Data Name	Description	Factory Setting				
				4th Digit	3rd Digit	2nd Digit	1st Digit	
Operation Mode Selection 3	06	S-curve at Accel / Decel Time	0.2 second S-curve	-	-	0	0	0000
			No S-curve	-	-	0	1	
			S-curve 0.5 second	-	-	1	0	
			S-curve 1.0 second	-	-	1	1	
		Input Reference	Response to master frequency reference: 0 to 100% at 0 to 10V (4 to 20mA)	-	0	-	-	
			Response to master frequency reference: 0 to 100% at 10 to 0V (20 to 4mA)	-	1	-	-	
		Processing When Frequency Reference is Missing	Stop by reference input	0	-	-	-	
Operation to continue with 80% of frequency reference	1		-	-	-			
Operation Mode Selection 4 (Overtorque Detection)	07	Overtorque Detection	Overtorque detection disabled	-	-	-	0	0000
			Overtorque detection enabled	-	-	-	1	
			Enabled only if at agreed frequency	-	-	0	-	
			Enabled during operation (except during DC injection)	-	-	1	-	
			Operation continued after overtorque is detected	-	0	-	-	
			Coasts to stop if overtorque is detected	-	1	-	-	
			Not used	0	-	-	-	
Operation Mode Selection 5	08	Priority of Frequency Reference (When input option card is used)	Frequency reference is from option card (if installed)	-	-	-	0	0100
			Frequency reference is from inverter	-	-	-	1	
		Priority of Run Command (When input option card is used)	Run command is from option card (if installed)	-	-	0	-	
			Run command is from inverter	-	-	1	-	

	Stopping Method Selection at Communication Interface Card (SC-C) Communication Error	Ramp stop (decel time: bn-02)	0	0	-	-	
		Coast to stop	0	1	-	-	
		Ramp stop (decel time: bn-04)	1	0	-	-	
		Operation to continue	1	1	-	-	

## 7.3 SYSTEM CONSTANTS **Sn-□□ (Cont'd)**

### System Constants List (3/5)

Function	Sn-□□	Data Name	Description	Factory Setting				
				4th Digit	3rd Digit	2nd Digit	1st Digit	
Operation Mode Selection 6	09	Analog Output Selection Method	Analog output (terminals 21-22) depends on Sn-05 4th digit and Sn-09 2nd digit	-	-	-	0	0000
			Analog output (terminals 21-22) is set by communication interface card (SC-C)	-	-	-	1	
		Analog Monitor Selection	Analog output (terminals 21-22) *3	-	-	0	-	
			Analog output (terminals 21-22) *3	-	-	1	-	
		—	—	0	0	-	-	
Protective Characteristic Selection 1 (Stall Prevention)	10	Stall Prevention	Stall prevention during acceleration enabled	-	-	-	0	0000
			Stall prevention during acceleration disabled	-	-	-	1	
			Stall prevention during deceleration enabled	-	-	0	-	
			Stall prevention during deceleration disabled	-	-	1	-	
			Stall prevention during running enabled	-	0	-	-	
			Stall prevention during running disabled	-	1	-	-	
			Decel time during stall prevention: "DECEL TIME 1" (bn-02 set value)	0	-	-	-	
			Decel time during stall prevention: "DECEL TIME 2" (bn-04 set value)	1	-	-	-	
Protective Characteristic Selection 2	11	DB Resistor	No. DB protection calculated or provided by inverter	-	-	-	0	0000
			Protection provided for TECO DB resistor only, if installed	-	-	-	1	
		Fault Contact during Auto	Fault contact is not energized during auto reset/restart operation	-	-	0	-	

	Reset/Restart Operation	Fault contact is energized during auto reset/restart operation	-	-	1	-	
		Operation stopped by momentary power loss detection	-	0	-	-	
		Operation continues after momentary power loss	-	1	-	-	
	———	Not used	0	-	-	-	

## 7.3 SYSTEM CONSTANTS **Sn-□□ (Cont'd)**

System Constants List (4/5)

Function	Sn- □□	Data Name	Description	Factory Setting				
				4th Digit	3rd Digit	2nd Digit	1st Digit	
Protective Characteristic Selection 3	12	External Fault Signal Level	External fault input: NO-contact input	-	-	-	0	0100
			External fault input: NC-contact input	-	-	-	1	
		Receiving External Fault Signal	External fault signal: Always detected	-	-	0	-	
			External fault signal: Detected during running only	-	-	1	-	
		Processing at External Fault Detection	Ramp stop (major fault)	0	0	-	-	
			Coast to stop (major fault)	0	1	-	-	
			Ramp stop (major fault): ramp stop (bn-04 set value)	1	0	-	-	
			Operation to continue (minor fault)	1	1	-	-	
Protective Characteristic Selection 4	13	Not used	—	—	—	—	—	
Protective Characteristic Selection 5	14	Motor Protection (Electronic Thermal)	Electronic thermal motor protection effective	-	-	-	0	0000
			Electronic thermal motor protection ineffective	-	-	-	1	
			Electronic thermal characteristics are in accordance with standard motor	-	-	0	-	
			Electronic thermal characteristics are in accordance with constant torque motor	-	-	1	-	
			Electronic thermal time constants are standard	-	0	-	-	
			Electronic thermal time constants are short-time rated	-	1	-	-	
		Inverter Protection (Electronic Thermal) *4	Inverter Protection OL: 103% continuous, 150% for one minute	0	-	-	-	
			Inverter Protection OL: 113% continuous, 123% for one minute	1	-	-	-	

## 7.3 SYSTEM CONSTANTS **Sn-□□ (Cont'd)**

### System Constants List (5/5)

Function	Sn- □□	Data Name	Description				Factory Setting		
							4th Digit	3rd Digit	2nd Digit
Multi-function Selection	Contact Input Signal	15	Terminal 5 Function	00 - FF	Selects terminal 5 function (factory preset for multi-step speed reference 1)				03
		16	Terminal 6 Function	00 - FF	Selects terminal 6 function (factory preset for multi-step speed reference 2)				04
		17	Terminal 7 Function	00 - FF	Selects terminal 7 function (factory preset for jog frequency reference)				06
		18	Terminal 8 Function	00 - FF	Selects terminal 8 function (factory preset for internal baseblock by NO contact input)				08
	Analog Input	19	Multi-function Analog Input	00 - FF	Selects multi-function analog input (terminal 16) function				00
	Output Signal	20	Multi-function Output 1	00 - FF	Selects multi-function contact output (terminals 9, 10) function (factory preset for during running)				00
		21	Multi-function Output 2	00 - FF	Selects multi-function open collector (terminal 25) function (factory preset for zero speed)				01
		22	Multi-function Output 3	00 - FF	Selects multi-function open collector (terminal 26) function (factory preset for agreed frequency)				02
Option Card Function Selection	25	Not used	—	—				—	
	26	Not used	—	—				—	
	27	Pulse Monitor Card PM-C (Number of Output Pulses) F: Inverter Output Frequency	X1 of inverter output frequency (1F)		0	0	0	-	001 -
			X6 of inverter output frequency (6F)		0	0	1	-	
			X10 of inverter output frequency (10F)		0	1	0	-	
			X12 of inverter output frequency (12F)		0	1	1	-	
X36 of inverter output frequency (36F)		1	0	0	-				
28	Not used	—	—				—		

\*1 Differs according to inverter capacity.

\*2 Initialization (Sn-03 = 1110, 1111)

After depressing the **ENTER** key, input the initial value of An-□□, bn-□□, Sn-□□, Cn-□□, (except Sn-01,Sn-02) into NV-RAM. When the value is written in without an error, is displayed. When the value is written in with an error, is displayed. The values of Sn-15 to -18 differ as follows between initializations with Sn-03 = 1110 and with Sn-03 = 1111.

Multi-function Terminal	1110 (2 Wire Sequence)	1111 (3 Wire Sequence)
Terminal 5 (Sn-15)	3* (Multi-step speed command 1)	0 (FWD/REV run select)
Terminal 6 (Sn-16)	4* (Multi-step speed command 2)	3 (Multi-step speed reference 1)
Terminal 7 (Sn-17)	6* (Jog frequency reference)	4 (Multi-step speed reference 2)
Terminal 8 (Sn-18)	8* (External baseblock command)	6 (Jog frequency reference)

\* Values have been factory-set.

\*3 Setting of Sn-05 4th digit and Sn-09 2nd digit.

Sn-05 4th Digit	Sn-09 2nd Digit	Description
0	0	Output analog signal proportional to inverter output frequency. (Max. frequency/100%)
1	0	Output analog signal proportional to inverter output current. (Rated current/100%)
0	1	Output analog signal proportional to inverter output voltage reference. (Cn-01/100%)
1	1	Output analog signal proportional to inverter output power. (Max. applicable motor capacity/100%)

\*4 Effective only for inverter models of capacity 230V 40HP (30kW) or more, 460V 75HP (55kW) or more.

## ▣ Inverter Capacity Selection **Sn-01**

Inverter capacity has been preset at the factory. However, if a spare control board is used, reset the inverter capacity referring to the table below. Control constant Cn-□□ factory setting values (initial values) differ according to Sn-01 setting.

### Inverter Capacity Selection

#### 230V Class

Name		Data of Sn-01									
		00	01	02	03	04	05	06	07		
Inverter rating	HP	0.5	1	2	3	5	7.5	10	15		
Inverter rated capacity	kVA	1.4	2.1	2.7	4.1	6.9	10.3	13.7	20.6		
Max. applicable motor capacity	HP (kW)	0.5 (0.4)	1 (0.75)	2 (1.5)	3 (2.2)	5 (3.7)	7.5 (5.5)	10 (7.5)	15 (11)		
Inverter rated current	A	3.2	4.8	6.4	9.6	16	24	32	48		
Factory Setting	Cn-09	Motor rated current	A	1.9	3.4	6.1	8.7	13.5	20.1	25.1	36.7
	Cn-23	Carrier frequency upper limit	kHz	15.0	15.0	15.0	15.0	15.0	15.0	15.0	15.0
	Cn-24	Carrier frequency lower limit	kHz	15.0	15.0	15.0	15.0	15.0	15.0	15.0	15.0
	Cn-25	Carrier frequency proportional gain		0	0	0	0	0	0	0	0
	Cn-31	Motor phase-to-phase resistance	Ω	11.760	5.732	2.407	1.583	0.684	0.444	0.288	0.159
	Cn-32	Torque compensation iron loss	W	48	64	108	142	208	252	285	370
	Cn-33	Torque compensation limit	V	50	50	50	50	50	50	50	50
	Cn-37	Momentary power loss assurance time	s	0.7	1.0	1.0	1.0	2.0	2.0	2.0	2.0
	Cn-40	Minimum baseblock time	s	0.5	0.5	0.5	0.5	0.5	0.7	0.7	0.7
Cn-41	V/f during speed search	%	100	100	100	100	100	100	100	100	



## 7.3 SYSTEM CONSTANTS **Sn-□□ (Cont'd)**

### Inverter Capacity Selection

230V Class

Name		Data of Sn-01		08	09	0A	0B	0C	0D	0E	0F
Inverter rating		HP		20	25	30	40	50	60	75	100
Inverter rated capacity		kVA		27.4	34	41	54	68	78	95	130
Max. applicable motor capacity		HP (kW)		20 (15)	25 (18.5)	30 (22)	40 (30)	50 (37)	60 (45)	75 (55)	100 (75)
Inverter rated current		A		64	80	96	130	160	183	224	300
Factory Setting	Cn-09	Motor rated current	A	50.3	62.9	72.9	96.7	124	143.5	183.5	230
	Cn-23	Carrier frequency upper limit	kHz	15.0	15.0	15.0	10.0	10.0	10.0	10.0	10.0
	Cn-24	Carrier frequency lower limit	kHz	15.0	15.0	15.0	10.0	10.0	10.0	10.0	10.0
	Cn-25	Carrier frequency proportional gain		0	0	0	36	36	36	36	36
	Cn-31	Motor phase-to-phase resistance	$\Omega$	0.109	0.077	0.060	0.041	0.033	0.028	0.019	0.007
	Cn-32	Torque compensation iron loss	W	471	425	582	536	641	737	790	1800
	Cn-33	Torque compensation limit	V	50	50	50	50	50	50	50	50
	Cn-37	Momentary power loss assurance time	s	2.0	2.0	2.0	2.0	2.0	2.0	2.0	2.0
	Cn-40	Minimum baseblock time	s	0.7	1.0	1.0	1.0	1.0	1.0	1.0	1.0
	Cn-41	V/f during speed search	%	100	100	100	80	80	80	80	80

## Inverter Capacity Selection

### 460V Class

Name		Data of Sn-01											
		20	21	22	23	24	25	26	27	28	29	2A	
Inverter rating HP		0.5	1	2	3	5	7.5	10	15	20	25	30	
Inverter rated capacity kVA		1.4	2.1	3.4	4.1	6.9	10.3	13.7	20.6	27.4	34	41	
Max. applicable motor capacity HP (kW)		0.5 (0.4)	1 (0.75)	2 (1.5)	3 (2.2)	5 (3.7)	7.5 (5.5)	10 (7.5)	15 (11)	20 (15)	25 (18.5)	30 (22)	
Inverter rated current A		1.6	2.6	4.0	4.8	8	12	16	24	32	40	48	
Factory Setting	Cn-09	Motor rated current A	1.0	1.7	2.9	4.0	6.8	10.0	12.6	18.6	24.8	31.1	36.3
	Cn-23	Carrier frequency upper limit kHz	15.0	15.0	15.0	15.0	15.0	15.0	15.0	15.0	15.0	15.0	15.0
	Cn-24	Carrier frequency lower limit kHz	15.0	15.0	15.0	15.0	15.0	15.0	15.0	15.0	15.0	15.0	15.0
	Cn-25	Carrier frequency proportional gain	0	0	0	0	0	0	0	0	0	0	0
	Cn-31	Motor phase-to-phase resistance $\Omega$	47.02	22.929	9.629	6.333	2.735	1.776	1.151	0.634	0.436	0.308	0.239
	Cn-32	Torque compensation iron loss W	48.1	63.9	108	142	208	252	285	370	471	425	582
	Cn-33	Torque compensation limit V	100	100	100	100	100	100	100	100	100	100	100
	Cn-37	Momentary power loss assurance time s	1.0	1.0	1.0	1.0	2.0	2.0	2.0	2.0	2.0	2.0	2.0
	Cn-40	Minimum baseblock time s	0.5	0.5	0.5	0.5	0.5	0.7	0.7	0.7	1.0	1.0	1.0
	Cn-41	V/f during speed search %	100	100	100	100	100	100	100	100	100	100	100

## 7.3 SYSTEM CONSTANTS **Sn-□□** (Cont'd)

### Inverter Capacity Selection

460V Class

		Data of Sn-01	2B	2C	2D	2E	2F	30	31	32	33	34	35	36	
Name															
Inverter rating		HP	40	50	60	75	100	125	150	175	215	250	300	400	
Inverter rated capacity		kVA	54	68	82	110	138	180	195	230	260	290	385	514	
Max. applicable motor capacity		HP (kW)	40 (30)	50 (37)	60 (45)	75 (55)	100 (75)	125	150 (110)	175	215 (160)	250 (185)	300 (220)	400 (300)	
Inverter rated current		A	64	80	96	128	165	192	224	270	300	340	450	600	
Factory Setting	Cn-09	Motor rated current	A	48.7	59.0	70.5	88.0	114	143	175	206	235	290	348	465
	Cn-23	Carrier frequency upper limit	kHz	15.0	10.0	10.0	10.0	10.0	10.0	10.0	10.0	10.0	2.0	2.0	2.0
	Cn-24	Carrier frequency lower limit	kHz	15.0	10.0	10.0	10.0	10.0	10.0	10.0	10.0	10.0	1.0	1.0	1.0
	Cn-25	Carrier frequency proportional gain		0	0	0	0	0	0	0	0	0	0	0	0
	Cn-31	Motor phase-to-phase resistance	Ω	0.164	0.133	0.110	0.074	0.027	0.036	0.036	0.020	0.022	0.020	0.022	0.014
	Cn-32	Torque compensation iron loss	W	536	641	737	790	1800	2900	2900	2600	2500	2600	1850	3600
	Cn-33	Torque compensation limit	V	100	100	100	100	100	100	100	100	100	100	100	100
	Cn-37	Momentary power loss assurance time	s	2.0	2.0	2.0	2.0	2.0	2.0	2.0	2.0	2.0	2.0	2.0	2.0
	Cn-40	Minimum baseblock time	s	1.0	1.0	1.0	1.0	1.0	1.0	2.0	2.0	2.0	2.0	2.0	2.0
	Cn-41	V/f during speed search	%	100	100	100	80	80	80	80	80	80	80	80	80

---

## ■ V/f Pattern Selection **Sn-02**

V/f pattern is selected by the setting of Sn-02. When V/f pattern is selected, set input voltage of the inverter in Cn-01.

- Data 0 - 9 (of Sn-02): Change disabled
- Data 10 (of Sn-02): Change enabled  
(V/f patterns are shown on the following pages).

## 7.3 SYSTEM CONSTANTS **Sn-□□ (Cont'd)**

V/f Pattern for 230V Class\* 0.5 to 2 HP (0.4 to 1.5kW)

Specifications		Sn-02	V/f Pattern+	Specifications		Sn-02	V/f Pattern+				
General-purpose	50Hz	0		High Starting Torque*	50Hz	8					
	60Hz	60Hz Saturation	Φ F		60Hz	Low Starting torque	A				
		50Hz Saturation	∅			High Starting torque	B				
72Hz		∅		90Hz		C					
Variable Torque Characteristics	50Hz	Variable torque 1		Rated Output Operation (Machine tool)	120Hz	D					
		Variable torque 2						∅			
	60Hz	Variable torque 3						∅	180Hz	E	
		Variable torque 4						∅			

\* For 460V class, 2 times voltage value shown in table above.

+ Consider the following items as conditions for selecting a V/f pattern. They must be suitable for:

- (1) The voltage and frequency characteristics of the motor.
- (2) The maximum rotation speed of the motor.

× Select high starting torque only in the following conditions. Normally, this selection is not required.

- (1) The wiring distance is long [492ft (150m) and above].
- (2) Voltage drop at startup is large.
- (3) AC reactor is inserted in the input or output of the inverter.

(4) A motor smaller than the maximum applicable inverter is used.  
 V/f Pattern of 230V Class\* 3 to 60 HP (2.2 to 45kW)

Specifications		Sn-02	V/f Pattern +	Specifications		Sn-02	V/f Pattern +			
General-purpose	50Hz	o		High Starting Torque*	50Hz	ø				
	60Hz	60Hz Saturation	ø F			60Hz	A			
		50Hz Saturation	ø			60Hz	B			
	72Hz		ø			90Hz		C		
	Variable Torque Characteristics	50Hz	Variable torque 1			Rated Output Operation (Machine tool)	120Hz		D	
			Variable torque 2				ø	180Hz	E	
60Hz		Variable torque 3	ø							
		Variable torque 4	ø							

\* For 460V class, 2 times voltage value shown in table above.

+ Consider the following items as conditions for selecting a V/f pattern. They must be suitable for:

- (1) The voltage and frequency characteristics of the motor.
- (2) The maximum rotation speed of the motor.

× Select high starting torque only in the following conditions. Normally, this selection is not required.

- (1) The wiring distance is long [492ft (150m) and above].
- (2) Voltage drop at startup is large.
- (3) AC reactor is inserted in the input or output of the inverter.
- (4) A motor smaller than the maximum applicable inverter is used.

## 7.3 SYSTEM CONSTANTS **Sn-□□ (Cont'd)**

V/f Pattern of 230V Class\* 75 and 100HP (55 and 75kW), (75 to 400HP for 460V class)

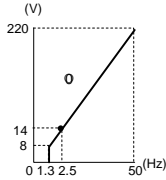
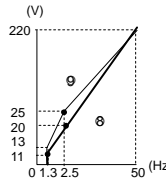
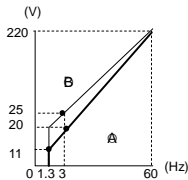
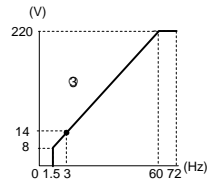
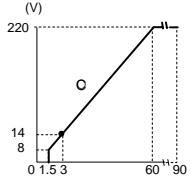
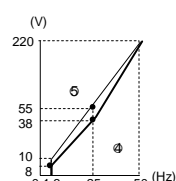
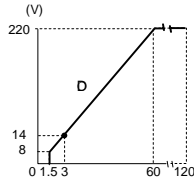
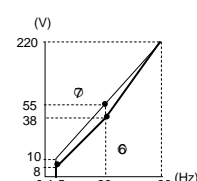
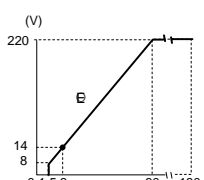
Specifications		Sn-02	V/f Pattern +	Specifications		Sn-02	V/f Pattern +		
General-purpose	50Hz	o		High Starting Torque*	50Hz	ø			
	60Hz	60Hz Saturation	φ		60Hz	Low Starting torque	A		
		50Hz Saturation	ø			High Starting torque	B		
72Hz		ø		90Hz		C			
Variable Torque Characteristics	50Hz	Variable torque 1		Rated Output Operation (Machine tool)	120Hz		D		
		Variable torque 2			ø	180Hz			E
	60Hz	Variable torque 3	ø			180Hz		E	
		Variable torque 4	ø						

\* For 460V class, 2 times voltage value shown in table above.

+ Consider the following items as conditions for selecting a V/f pattern. They must be suitable for:

- (1) The voltage and frequency characteristics of the motor.
- (2) The maximum rotation speed of the motor.

× Select high starting torque only in the following conditions. Normally, this selection is not required.

- (1) The wiring distance is long [492ft (150m) and above].
- (2) Voltage drop at startup is large.
- (3) AC reactor is inserted in the input or output of the inverter.
- (4) A motor smaller than the maximum applicable inverter is used.

## ■ Operation Mode Selection 1 **Sn-04**

### (1) 1st digit (frequency reference selection)

1st digit = 0: Reference input from control circuit terminal 13 or 14 is the master speed frequency reference.

1st digit = 1: Frequency reference 1 (An-01) is the master speed frequency reference.

Note: For combination of multi-step speed operation, refer to pages 36 and 85.

### (2) 2nd digit (run command selection)

2nd digit = 0: Run command from control circuit terminal is accepted.

2nd digit = 1: Run command from the digital operator is accepted.

Valid run command and frequency references differ as shown in the table below, depending on the combination of the 1st and 2nd digits.

CONSTANT REFERENCE	SYSTEM CONSTANTS 4	2nd digit	1st digit	2nd digit	1st digit	2nd digit	1st digit	2nd digit	1st digit
		0	0	0	1	1	0	1	1
Control Terminal	Master Speed Frequency Reference	Control circuit terminal 13, 14		An-01		Control circuit terminal 13, 14		An-01	
	FWD Run Command (Terminal 1)	○	○	○	○	×	×	×	×
	REV Run Command (Terminal 2)	○	○	○	○	×	×	×	×
	External Fault (Terminal 3)	○	○	○	○	○	○	○	○
	Fault Reset (Terminal 4)	*	*	*	*	*	*	*	*
	Command of Terminal 5	○	○	○	○	+	+	+	+
	Command of Terminal 6	○	○	○	○	○	○	○	○
	Command of Terminal 7	○	○	○	○	○	○	○	○
	Command of Terminal 8	○	○	○	○	○	○	○	○
	Aux. Input	○	○	○	○	○	○	○	○
	Fault Contact Output	○	○	○	○	○	○	○	○
	Multi-function Contact Output	○	○	○	○	○	○	○	○
Multi-function PHC Output	○	○	○	○	○	○	○	○	
Operator	RUN Key	×	×	×	×	○	○	○	○
	JOG Key	×	×	×	×	○	○	○	○
	STOP Key	※	※	※	※	○	○	○	○
	FWD/REV Key	×	×	×	×	○	○	○	○
	>/RESET Key	*	*	*	*	*	*	*	*
	DRIVE/PRGM Key	Valid only when inverter stopped		Valid only when inverter stopped		Valid only when inverter stopped		Valid only when inverter stopped	
	REF LED	Lit		OFF		Lit		OFF	
	SEQ LED	Lit		Lit		OFF		OFF	
Monitor display	○	○	○	○	○	○	○	○	

\* Valid only when the inverter stops. (FWD run command, REV run command, and DC injection braking command are "open".)

+ FWD/REV run command is not accepted.

※ When the STOP key is depressed, processing differs as follows, depending on the setting of the 1st digit of Sn-05.

1st digit = 0: During running by signals from control circuit terminals, the STOP key from the operator is accepted.



If the STOP key is depressed, the inverter stops according to the setting of 3rd and 4th digits of Sn-04, while the STOP LED indicator blinks. This stop command is held within the inverter until both the FWD run command and REV run command of control circuit terminals become "open", or another frequency reference is selected in the multi-step speed command or jog frequency reference section.

1st digit=1: During running by signals from control circuit terminals, the STOP key from the operator is not accepted.

## 7.3 SYSTEM CONSTANTS **Sn-□□** (Cont'd)

### (3) 3rd digit, 4th digit (stop method selection)

Stop method differs by the setting of 3rd and 4th digits as shown below.

① Sn-04 = 00 XX RAMP stop

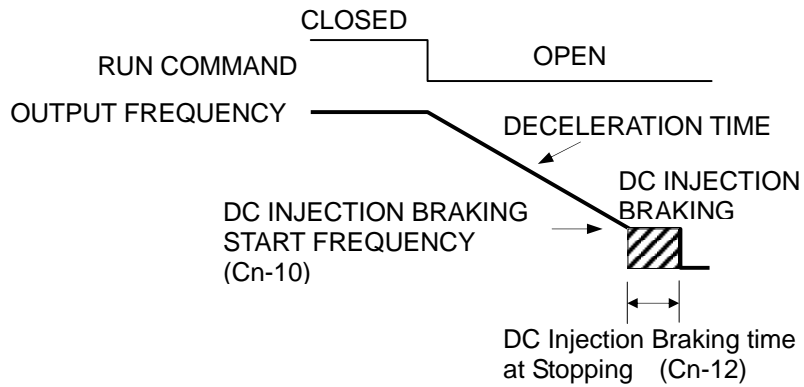

② Sn-04 = 01 XX Coast to stop

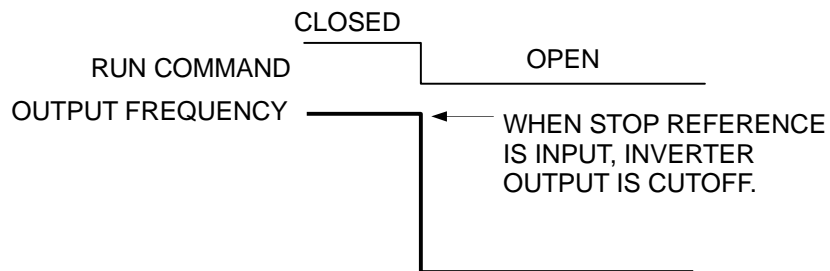

③ Sn-04 = 10 XX Full-range DC injection braking stop

DC injection braking time differs by the output frequency when stop command is input as shown below.

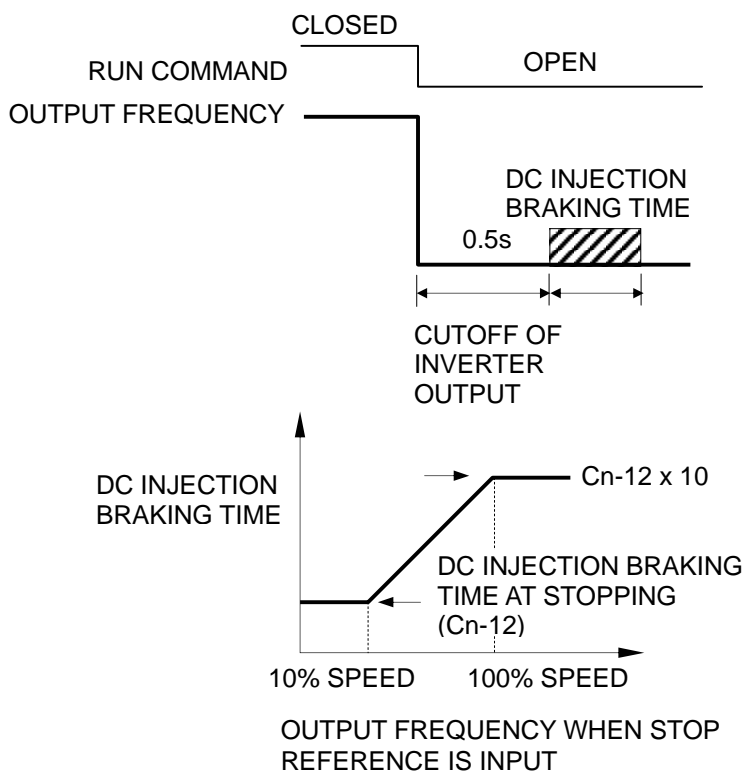

④ Sn-04 = 11 XX Coasting to a Stop (timer function provided)

Once stop command is input, run command is disregarded during  $T_1$  time.

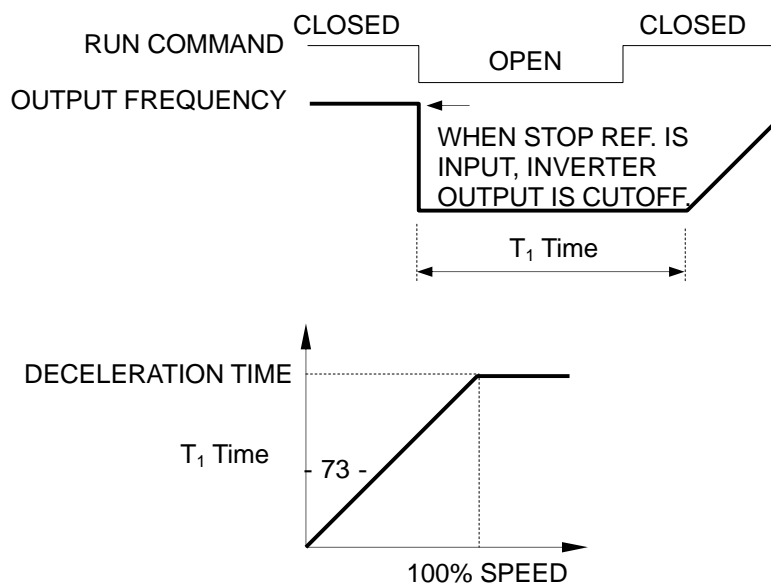

OUTPUT FREQUENCY WHEN  
STOP REFERENCE IS INPUT.

7.3 SYSTEM CONSTANTS **Sn-□□ (Cont'd)**

■ Operation Mode Selection 2 **Sn-05**

**(1) 1st digit**

Select processing to be performed when the STOP key of the digital operator is depressed during running by control circuit terminals.

1st digit 0: During running by signals from control circuit terminals, the STOP key from the digital operator is accepted. If the STOP key is depressed, the inverter stops according to the setting of the 3rd and 4th digits of Sn-04 while the STOP LED indicator blinks. This stop command is held within the inverter until both the FWD run command and REV run command of control circuit terminals become "open", or other frequency reference is selected in the multi-step speed command or jog frequency reference section.

1st digit 1: During running by signals from control circuit terminals, the STOP key from the digital operator is not accepted.

**(2) 2nd digit (REV run prohibited)**

2nd digit = 0: REV run command from control circuit terminals or the digital operator is accepted.

2nd digit = 1: REV run command from control circuit terminals or the digital operator is not accepted.

**(3) 3rd digit (selection of double scanning sequence command)**

3rd digit = 0: Sequence command (control circuit terminals 1 to 8) is scanned twice.

3rd digit = 1: Sequence command (control circuit terminals 1 to 8) is scanned once.

**(4) 4th digit (selection of the multi-function analog output)**

Multi-function analog output (control circuit terminals 21, 22) output signal can be selected by Sn-05 4th digit and Sn-09 2nd digit.

Sn-05 4th Digit	Sn-09 2nd Digit	Description
0	0	Outputs analog signal proportional to inverter output frequency. (Max. frequency/100%)
1	0	Outputs analog signal proportional to inverter current. (Rated current/100%)

---

0	1	Outputs analog signal proportional to inverter output voltage reference. (Cn-01/100%)
1	1	Outputs analog signal proportional to inverter output power. (Max motor capacity/100%)

## ■■ Operation Mode Selection 3 Sn-06

### (1) 1st digit, 2nd digit (S-curve selection of soft starter)

The S-curve characteristics of the soft starter depend on the setting of the 1st and 2nd digits as follows:

2nd digit	1st digit	Contents
0	0	The S-curve characteristic is 0.2 second.
0	1	No S-curve characteristics.
1	0	The S-curve characteristic is 0.5 second.
1	1	The S-curve characteristic is 1 second.

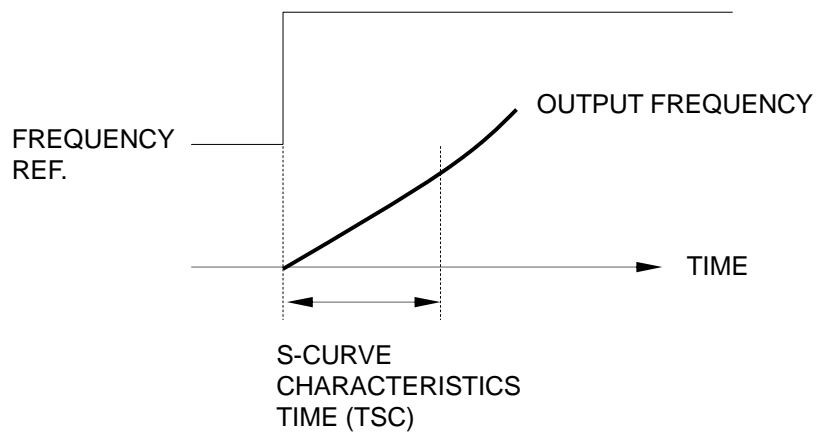

Note: S-curve characteristic time refers to the time from acceleration rate 0 to the time when a normal acceleration rate determined by a specified acceleration time is obtained.

### (a) Time chart at FWD/REV run change with S-curve characteristic

The figure below shows the time chart at FWD/REV run change during deceleration and stop.

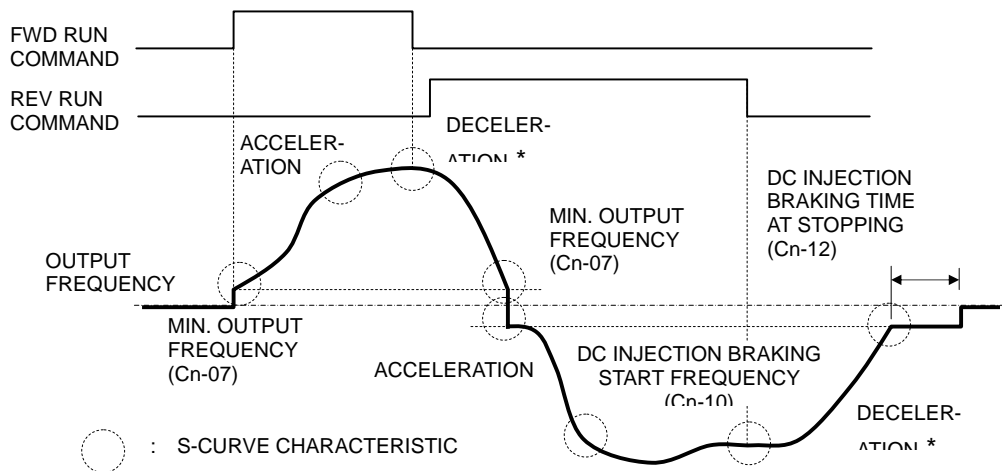

\* When 1st and 2nd digits are 00, no S-curve characteristic at completion

of deceleration.

## 7.3 SYSTEM CONSTANTS **Sn-□□ (Cont'd)**

### (b) The chart at FWD/REV run change without S-curve characteristic

The figure below shows the time chart at FWD/REV run change during deceleration and stop.

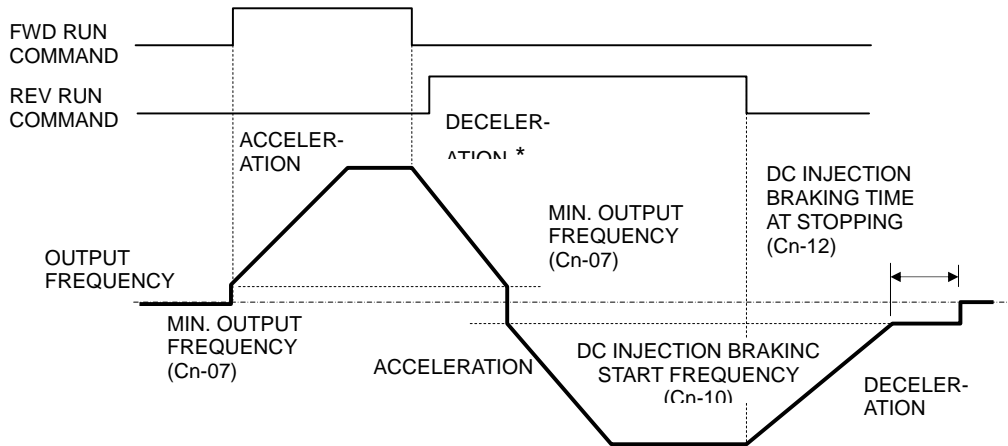

### (2) 3rd digit (reverse characteristic selection)

The input characteristics of the master speed frequency reference depend on the set value as follows. For the reverse characteristic, only + input is valid.

3rd digit = 0: Normal characteristic (0-10V or 4-20mA/0-100%)

3rd digit = 1: Reverse characteristic (10-0V or 20-4mA/0-100%)

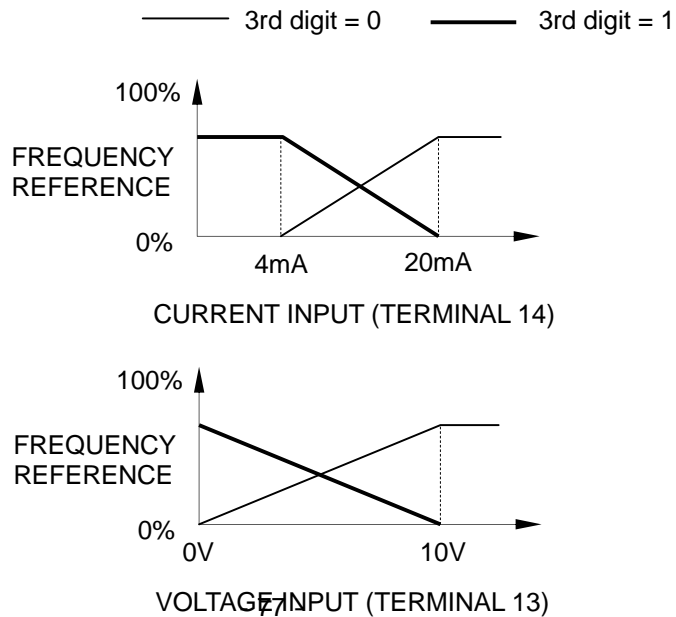

**(3) 4th digit** (operation selection when frequency reference is missing)

4th digit = 0: Normal operation (varies with change of reference)

4th digit = 1: Operation continues with 80% frequency.

When 4th digit = 1 is set, the current master speed frequency reference is compared at all times with the one that occurred 0.4 second before. When the current master speed frequency reference goes below 10% of the one that occurred 0.4 second before, operation continues with 80% (80% frequency) of the master speed frequency reference of the prior one. Consequently, the master speed frequency reference of the previous one (0.4 second before) is used as the current frequency reference.

In the following cases, this operation is released and the inverter returns to normal operation:

- Master speed frequency reference exceeding 80% frequency is input.
- Stop reference is input.
- Reference is missing during operation at less than 5% of frequency.

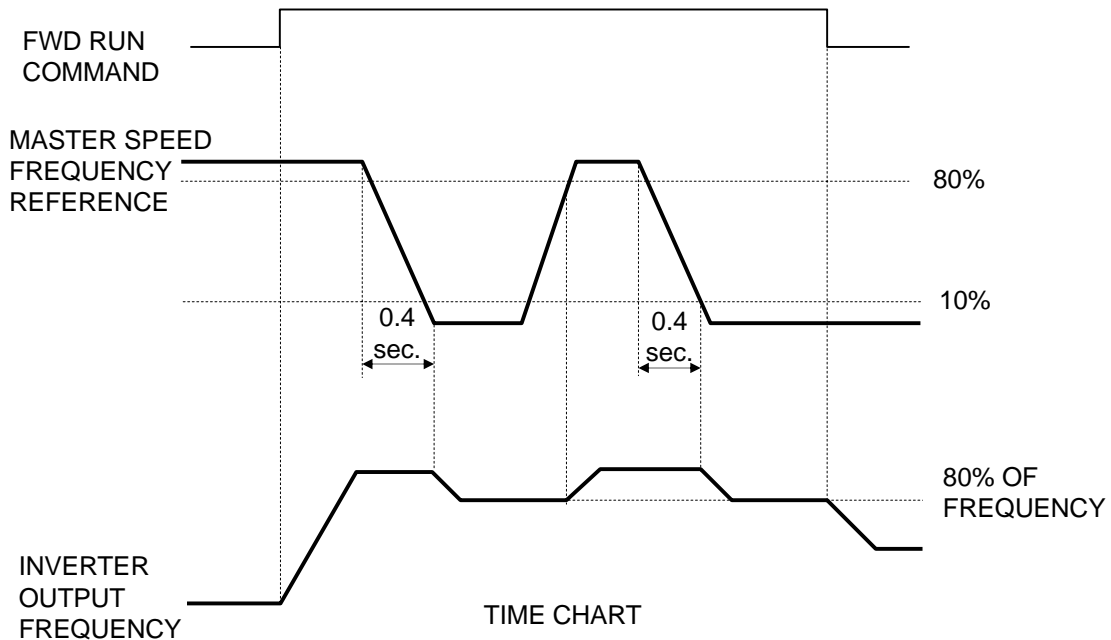

## 7.3 SYSTEM CONSTANTS **Sn-□□ (Cont'd)**

### ■ Operation Mode Selection 4 **Sn-07**

Define the operation at overtorque detection. Overtorque is detected by the following formula:

Inverter output current B overtorque detection level (Cn-26, Initial value: 160%)  
(Detection time Cn-27, Initial value: 0.1 second, Hysteresis fixed at 10%)

#### (1) 1st digit

- 1st digit = 0: Overtorque is not detected.
- 1st digit = 1: Overtorque is detected.

#### (2) 2nd digit

- 2nd digit = 0: Overtorque is detected only during agreed frequency.
- 2nd digit = 1: Overtorque is detected during stop or during running except for DB.

#### (3) 3rd digit

- 3rd digit = 0: When overtorque is detected,  $\square L \square$  blinks on the digital operator and the operation continues.
- 3rd digit = 1: When overtorque is detected,  $\square L \square$  is displayed on the digital operator and the inverter output is shut OFF. Fault contact signal is output. (Treated as a fault).

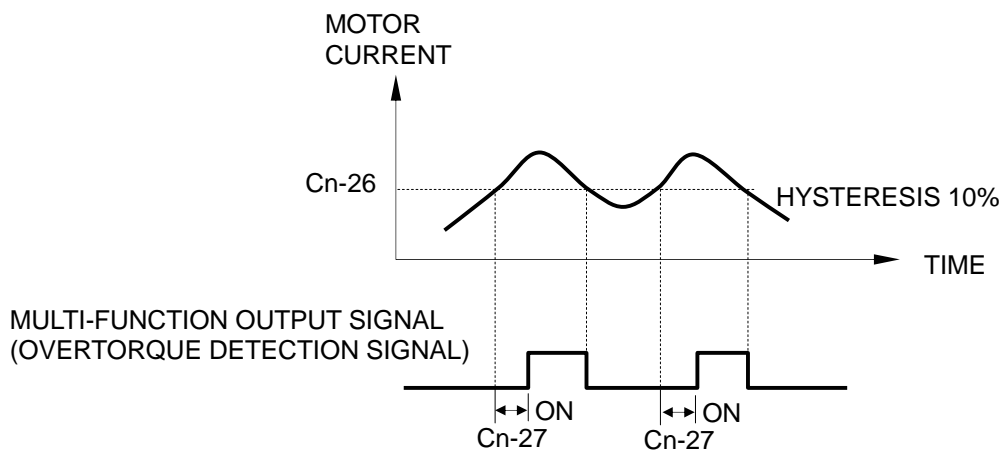

Setting either Sn-20 or 22 to "0B" enables signal to be output at overtorque detection.



---

---

**■ Operation Mode Selection 5 Sn-08****(1) 1st digit** (option/inverter change)

Specify whether option card or inverter frequency reference is used for operation.

1st digit = 0: Option card frequency reference is accepted.

1st digit = 1: Frequency reference from inverter control circuit terminals or the digital operator is accepted.

**(2) 2nd digit** (run command option/inverter change)

Select whether operation is performed by the option card or inverter run command.

2nd digit = 0: Run command from option card received.

2nd digit = 1: Run command from inverter control circuit terminal or digital operator received.

**(3) 3rd digit, 4th digit** (selection of stopping method at communication error detection)

Stopping method at communication error detection can be selected by communication interface card (SC-C).

4th digit	3rd digit	Contents
0	0	Ramp stop by bn-02 (major fault)
0	1	Coast to stop (major fault)
1	0	Ramp stop by bn-04 (major fault)
1	1	Operation to continue (minor fault)

---

## 7.3 SYSTEM CONSTANT **Sn-□□** (Cont'd)

### ■ Operation Mode Selection 6 **Sn-09**

#### (1) 1st digit (selection of analog output)

Multi-function analog output signal contents can be set either by the inverter or option card.

1st digit = 0: Output according to Sn-05 4th digit and Sn-09 2nd digit setting contents.

1st digit = 1: Output according to contents set by communication interface card (SC-C).

#### (1) 2nd digit (selection of multi-function analog output signal)

Multi-function analog output (control circuit terminals 21 - 22) output signal can be selected according to Sn-05 4th digit and Sn-09 2nd digit set value. Output signal level is set by bn-11.

Sn-05 4th Digit	Sn-09 2nd Digit	Description
0	0	Outputs analog signal proportional to inverter output frequency. (Max. frequency/100%)
1	0	Outputs analog signal proportional to inverter current. (Rated current/100%)
0	1	Outputs analog signal proportional to inverter output voltage reference. (Cn-01/100%)
1	1	Outputs analog signal proportional to inverter output power. (Max. applicable motor capacity/100%)

---

## ■ Protective Characteristic Selection 1 **Sn-10**

### (1) 1st digit (selection of stall prevention during acceleration)

1st digit = 0: Stall prevention during acceleration is enabled.

1st digit = 1: Stall prevention during acceleration is disabled.

The function of stall prevention during acceleration automatically extends acceleration according to load status (inverter output current), thus preventing the motor from stalling during acceleration. The stall prevention level during acceleration in a constant output area is reduced as follows:

$$\text{Acceleration stall prevention level of constant output field} = \frac{\text{acceleration stall prevention level (Cn-28)} \times \text{maximum voltage frequency (Cn-04)}}{\text{output frequency}}$$

When the 1st digit of Sn-10 is 1, the output frequency increases at the rate determined by acceleration time:

### (2) 2nd digit (selection of stall prevention during deceleration)

2nd digit = 0: Stall prevention during deceleration is enabled.

2nd digit = 1: Stall prevention during deceleration is disabled.

The function of stall prevention during deceleration automatically extends deceleration time according to the magnitude of the main circuit DC voltage, thus preventing overvoltage during deceleration.

When the 2nd digit of Sn-10 is 1, the output frequency decreases at the rate determined by deceleration time. For positioning applications, specify "stall prevention during deceleration not provided" (2nd digit = 1) in order to obtain stopping accuracy. With large inertia loads, use a braking resistor to prevent overvoltage.

## 7.3 SYSTEM CONSTANTS **Sn-□□** (Cont'd)

### (3) 3rd digit (stall prevention during running)

3rd digit = 0: Stall prevention during running is enabled.

3rd digit = 1: Stall prevention during running is disabled.

Stall prevention operation during running starts decelerating when the output current reaches 100ms or greater than the set value of Cn-30 during frequency coincidence (operation level of stall prevention during running). The inverter decelerates as long as the output current exceeds the set value of Cn-30 (operation level of stall prevention during running). When the output current goes below the set value, the inverter reaccelerates. The deceleration time selected in the 4th digit of Sn-10 is taken. Even during stall prevention while running, stall prevention during deceleration and stall prevention during acceleration are enabled.

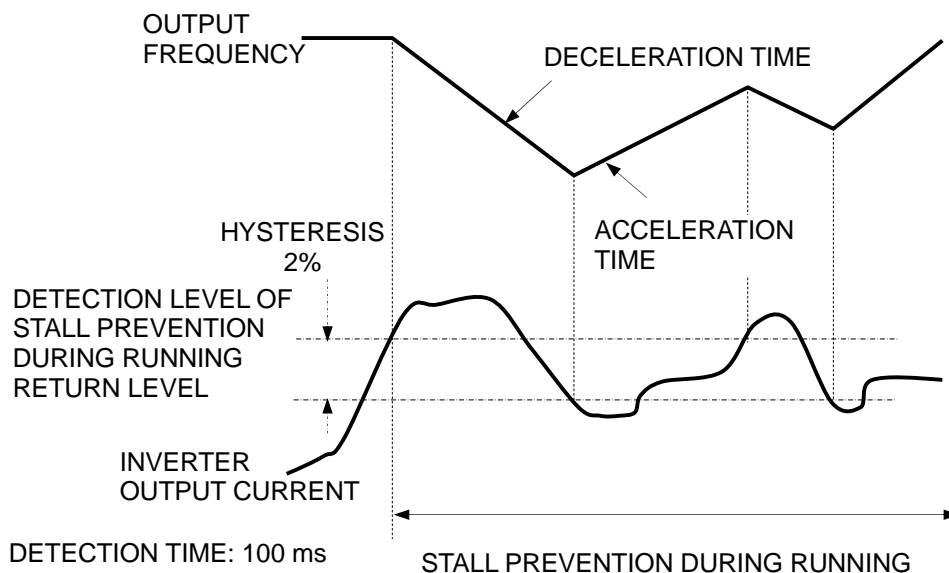

### (4) 4th digit (selection of deceleration time during stall prevention while running)

4th digit = 0: The inverter decelerates for the deceleration time specified in bn-02.

4th digit = 1: The inverter decelerates for the deceleration time specified in bn-04.

## ■ Protective Characteristic Selection 2 **Sn-11**

### (1) 1st digit (existence of braking resistor)

1st digit = 0: Braking resistor protection not provided (braking resistor is not protected from overheating).

1st digit = 1: Braking resistor protection provided (braking resistor is protected from overheating).

On detecting overheating in the braking resistor, the inverter lights rH on the operator, shuts off inverter output, and outputs fault contacts. When braking contact failure (set value = D) is selected in the multi-function contact output, the pertinent multifunction contact output is output.

The following inverters can optionally accept braking resistors:

230V class: 5HP (3.7kW) or less

460V class: 3HP (2.2kW) or less

Notes:

#### 1. Braking transistor operation level

Braking transistor operation levels depend on input voltage as shown below.

When the set value of Cn-01 is larger than the motor rated voltage, the following problems may occur. (Set Cn-01 to match the motor rated voltage).

(a) The motor is excited excessively during deceleration and heated.

(b) The motor vibrates during deceleration.

(c) The motor is saturated during deceleration and the main circuit devices are damaged.

Input Voltage (Cn-01)		LVH Signal	OV Level		BTR Level		UV Level	
Inverter	Set value		Detection	Return	Detection	Return	Detection	Return
230V Class	255 or less	L	400	380	380	375	210	220
460V Class	Set value $\geq$ 400	L	800	760	760	750	420	440
460V Class	Set value < 400	H	700	660	660	650	420	440

#### 2. Protection of braking transistor

The braking transistors are incorporated into the following models:

- 230V : 20HP (15kW) or smaller

- 460V : 20HP (15kW) or smaller to protect them.

On detecting a fault in the braking transistors, the inverter lights  $\overline{r}$  at the operator and shuts off the inverter output and braking transistor drive signal (BTA). It outputs fault contacts.

## 7.3 SYSTEM CONSTANTS **Sn-□□ (Cont'd)**

### (2) 2nd digit (fault contact signal during auto reset/restart operation)

2nd digit = 0: A fault contact signal is not output during auto reset/restart operation.

2nd digit = 1: A fault contact signal is output during auto reset/restart operation.

### (3) 3rd digit (operation continued at momentary power loss)

3rd digit = 0: When momentary power loss is detected, undervoltage fault ( $\underline{U} \underline{V} \underline{I}$ ) occurs and the inverter output is shut OFF.

3rd digit = 1: If momentary power loss time is within momentary power loss ride-thru time (Cn-37), the operation continues after the momentary power loss. If the momentary power loss ride-thru time is exceeded, undervoltage fault ( $\underline{U} \underline{V} \underline{I}$ ) occurs and the inverter output is shut OFF.

Notes:

1. When the 3rd digit = 1, be sure not to shut OFF the external sequence signal. (e.g. FWD, REV)
2. For lifters, do not use this function. (the 3rd digit = 0)

## ■ Protective Characteristic Selection 3 **Sn-12**

When an external fault signal of terminal 3 is input,  $\underline{E} \underline{F} \underline{3}$  is displayed and a fault contact signal is output immediately. The inverter stops according to the setting of the 3rd and 4th digits. The external fault signal is held within the inverter until a fault reset signal is input.

### (1) 1st digit (level selection of external fault signal)

1st digit = 0: NO contact input (when "closed", external fault operation is performed).

1st digit = 1: NC contact input (when "open", external fault operation is performed).

### (2) 2nd digit (acceptance of external fault signal)

2nd digit = 0: External fault signals are always accepted.

2nd digit = 1: External fault signals are accepted only during running. (Not accepted during baseblock).

### (3) 3rd digit, 4th digit (selection of processing at external fault detection)

4th digit	3rd digit	Contents
0	0	Ramp stop by bn-02 (major fault)
0	1	Coast to stop (major fault)
1	0	Ramp stop by bn-04 (major fault)

1	1	Operation to continue (minor fault)
---	---	-------------------------------------

## ■ Protective Characteristic Selection 5 **Sn-14**

### (1) 1st digit (motor protection)

1st digit = 0: Electronic thermal motor protection is enabled.

1st digit = 1: Electronic thermal motor protection is disabled.

### (2) 2nd digit (selection of electronic thermal characteristics)

2nd digit = 0: Electronic thermal characteristics are in accordance with reduced torque motor (standard motor).

2nd digit = 1: Electronic thermal characteristics are in accordance with constant torque motor (special motor).

### (3) 3rd digit (electronic thermal time constant)

3rd digit = 1: Used for standard motor and special motor (standard ratings).

3rd digit = 1: Used for motors other than the above (short-time ratings).

### (4) 4th digit (selection of inverter protective characteristics)

4th digit = 0: When inverter output current exceeds 103%, the inverter protection electronic thermal characteristics start operating: Inverter protection ( $\square \angle \vec{c}$ ) operates at 150% for one minute to shut OFF inverter output.

4th digit = 1: When inverter output current exceeds 113%, the inverter protection electronic thermal characteristics start operating: Inverter protection ( $\square \angle \vec{c}$ ) operates at 123% for one minute to shut OFF inverter output.

Note: This function is effective only for inverter models with capacity 40HP (30kW) or larger (230V class), and 75HP (55kW) or larger (460V class).



## 7.4 MULTI - FUNCTION CONTACT INPUT SELECTION **Sn-15 to -18**

Select the set values shown below for Sn-15 to -18.

Terminal No.	Sn-□□
Terminal 5	15
Terminal 6	16
Terminal 7	17
Terminal 8	18

Set Value	Function	Description
00	FWD / REV RUN selection	Open: FWD run, Closed: REV run, ( 3-wire sequence mode (00 set in Sn-15) terminal 1-run , 2-stop, 5 FWD / REV selection. )
01	Operation signal selection Local/Remote	Open: Operated according to setting of Sn-04 1st and 2nd digits. Closed: Operated by frequency reference and run command from digital operator.
02	Option / inverter reference selection	Open: Operated by frequency reference from option card. Closed: Operated by frequency reference from the inverter.
03	Multi-step speed reference 1	Combination of multi-step speed references 1 to 3 correspond to speed reference (master speed An-01) and speed references 2 to 8 (An-02 to 08). Refer to "SYSTEM CONSTANTS MULTI-STEP SPEED REFERENCE LIST".
04	Multi-step speed reference 2	
05	Multi-step speed reference 3	
06	Jog frequency reference selection	Closed: Jog frequency reference is selected.
07	Accel / decel time selection	Open: Accelerates/decelerates with ACCEL time 1 and DECEL time 1. (bn-01, bn-02 set values) Closed: Accelerates/decelerates with ACCEL time 2 and DECEL time 2. (bn-03, bn-04 set values)
08	External baseblock (NO contact input)	Closed: Inverter output is shut OFF. (Frequency reference is held).
09	External baseblock (NC contact input)	Open: Inverter output is shut OFF. (Frequency reference is held).
0A	Accel / decel speed prohibit command (HOLD command)	Frequency reference is held. (SFS operation is stopped).
0B	Inverter overheat alarm	Closed: OH2 blinks on operator and operation continues. (Mirror fault)
0C	Multi-function analog input enabled / disabled	Closed: Multi-function analog input is enabled. (terminal 16) Open: Multi-function analog input is disabled. (terminal 16)
0D to 0F	Not used	—

Set Value	Function	Description
10	UP command	Closed: Output frequency increment
11	DOWN command	Closed: Output frequency decrement
12	FJOG command	Closed: Forward jog run FWD LED lights. Display: 6Hz
13	RJOG command	Closed: Reverse jog run Digital operator REV LED does not light. Display: 6Hz
14 to 1F	Not used	—
20 to 2F	External fault 1	External fault signal input
30 to 3F	External fault 2	
40 to 4F	External fault 3	
50 to 5F	External fault 4	
60	DC injection braking command (JOG with priority)	Closed: DC injection braking applied when the frequency output is less than the DC injection start frequency and the DC injection braking command is closed.
61	Search 1	Closed: Search from max frequency
62	Search 2	Closed: Search from set frequency
63	Energy-saving operation	Closed: Energy-saving
64	Not used	—
65 to FF	Not used	—

Setting error (OPE3) occurs by setting to Sn-15 to -18 in the following cases.

- When set values are not listed from smaller to the larger.
- When more than two search references of set values 61, 62 and 64 are set simultaneously.

When the following combination is set at Sn-15 to -18, set value fault (OPE3) occurs.

1. Set values are not in descending order.
2. More than two search commands of set values 61 and 62 are set.
3. UP/DOWN commands are not set simultaneously. (only one command can be set)
4. UP/DOWN and accel/decel prohibit commands are set simultaneously.
5. More than two set values except FF are set.

## 7.4 MULTI-FUNCTION CONTACT INPUT SELECTION **Sn-15 to -18** (Cont'd)

### (1) FWD/REV run selection (set value = 0)

When 0 is set in Sn-15, the mode becomes 3-wire sequence mode.

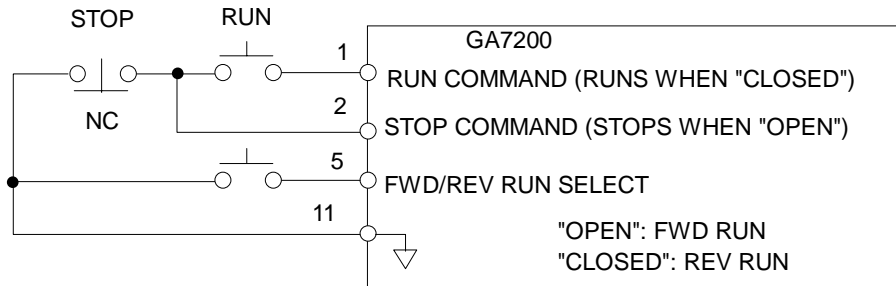

### (2) Operation signal selection (set value = 1)

Selection of operation signals is enabled only while the inverter is not running.

Open: The inverter operates according to the setting of 1st, 2nd digits.

Closed: The inverter operates by frequency reference and run command from the digital operator.

< Example >

For local/remote mode selection, set Sn-04 = x x 00.

Open: Frequency reference and run command from control circuit terminals are accepted.

Closed: Frequency reference and run command from the digital operator is accepted.

### (3) Option card/inverter reference selection (set value = 2)

Specify which of the option cards or inverter references is used for operation. The option card/inverter selection is effective only while the inverter is not running.

Open: Option card frequency reference and operation signals are accepted.

Closed: Frequency reference and operation signals from the inverter control circuit terminals or the digital operator are accepted.

### (4) Selection of multi-step speed references 1 to 3 and jogging frequency selection (set values = 3 to 6)

Up to nine step speeds can be selected by combinations of multi-step speed references and jog frequencies.

○: Closed    ×: Open    -: No relation

Jog Frequency Reference Selection	Multi-Step Reference			Frequency Reference
	3	2	1	
×	×	×	×	Master speed frequency reference*
×	×	×	○	Auxiliary analog reference
×	×	○	×	Frequency reference 3 (An-03)
×	×	○	○	Frequency reference 4 (An-04)
×	○	×	×	Frequency reference 5 (An-05)
×	○	×	○	Frequency reference 6 (An-06)
×	○	○	×	Frequency reference 7 (An-07)
×	○	○	○	Frequency reference 8 (An-08)
○	-	-	-	Jog frequency reference 3 (An-09)

\* In operator mode (1st digit of Sn-04 is 1), frequency reference 1 (An-01) is enabled.

+ When the multi-function analog input is selected by functions other the frequency reference (Sn-19 = 0), frequency reference 2 (An-02) becomes effective. When the multi-function analog input is not used, set F to the set value.

- For multi-step speed operation with frequency reference from digital operator, perform the following setting:

① Sn-04 = xxx1 → An-01 becomes effective.

② Sn-19 = 0F → An-02 becomes effective.

#### (5) Accel/decel time selection (select value = 7)

Accel/decel time is switched when "closed". Switching is permitted even during acceleration or deceleration.

Open: The accel/decel time set by bn-01 and bn-02 is accepted.

Closed: The accel/decel time set by bn-03 and bn-04 is accepted.

#### (6) External baseblock (set value = 8)

Baseblock is performed when "closed". External baseblock differs as follows depending on the input status of the run command:

- When an external baseblock signal is input during running,  $\overline{L}$   $\overline{L}$  blinks on the digital operator and inverter output is shut OFF. When the external baseblock signal disappears, the inverter restarts with the frequency reference at that time. The voltage returns to the set value in the voltage recovery time.
- When a stop signal is input and an external baseblock signal is input while the inverter is decelerating,  $\overline{L}$   $\overline{L}$  blinks on the digital operator, the inverter output is shut OFF, and the output frequency is set to 0Hz.

---

## 7.4 MULTI-FUNCTION CONTACT INPUT SELECTION **Sn-15 to -18 (Cont'd)**

### (7) External baseblock (set value =9)

Baseblock is performed when "open". All other operations are the same as when set value = 8.

### (8) Accel/decel speed prohibit command (set value = A)

As long as accel/decel speed prohibit command is input, accel/decel speed is prohibited and the output frequency at that time is held. When stop command is input, accel/decel speed prohibit state is freed and the system enters stop state. The figure below shows a time chart.

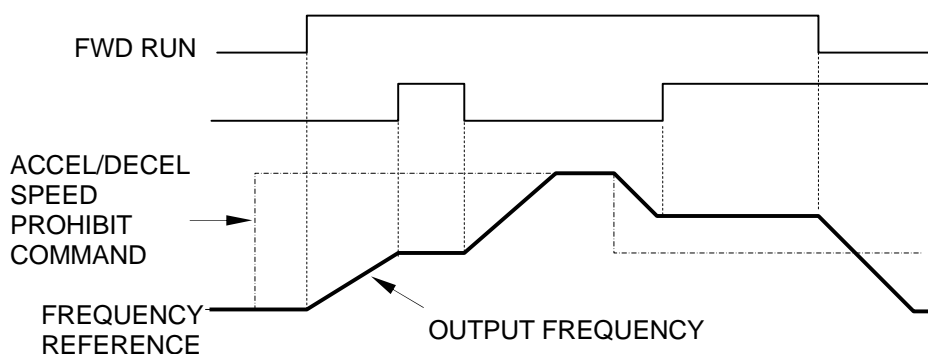

Note: If the run command is input again after the stop command is input while the accel/decel prohibit command is input, the holding output frequency is stored unless the accel/decel prohibit command is released. Therefore, operation is performed at the stored output frequency. Also when the power supply is turned OFF in the accel/decel prohibit command input status, the holding output frequency is still stored.

### (9) Inverter overheat alarm (set value = B)

As long as an inverter overheat signal is input,  $\overline{O}H\overline{2}$  blinks on the digital operator.

### (10) Auxiliary analog reference input (set value = C)

When this function is selected by the multi-function terminal, the function set in the multi-function analog input is subject to the following restrictions.

Open: Multi-function analog input is not accepted.  
(Same operation as when F is set in Sn-19)

Closed: Multi-function analog input is accepted.

**(11) UP command/DOWN command (set value = 10, 11)**

Acceleration/deceleration is performed by inputting the UP/DOWN commands without changing frequency reference in the forward (reverse) run command input status and operation can be performed at a desired speed.

Set value = 10: UP command

Set value = 11: DOWN command

UP command	Closed	Open	Open	Closed
DOWN command	Open	Closed	Open	Closed
Status	Accel	Decel	Hold	Hold

The following time chart indicates when the UP/DOWN commands are used.

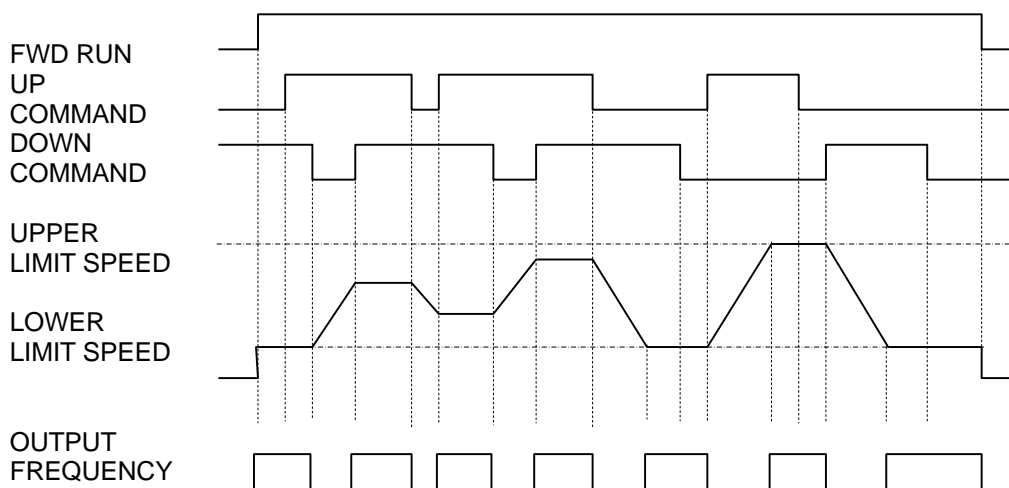

- U = UP (accel) status
- D = DOWN (decel) status
- H = HOLD (constant speed) status
- U1 = During clamp at upper limit speed even in UP status
- D1 = During clamp at lower limit speed even in DOWN status

---

## 7.4 MULTI-FUNCTION CONTACT INPUT SELECTION **Sn-15 to -18 (Cont'd)**

Notes:

1. When the UP/DOWN commands are used, set Sn-04 1st digit (frequency reference selection) as shown below.

Set 1st digit = 0 without fail.  
Setting 1st digit = 1 disables the UP/DOWN commands.

2. When the UP/DOWN commands are selected, upper limit speed is set disregarding frequency reference.

Upper limit speed = max. output freq. (Cn-02) × freq. reference lower limit (Cn-14)

3. The largest value among minimum output frequency (Cn-07), frequency reference lower limit (Cn-15) and main frequency reference input from control circuit terminal 13 or 14 is employed as lower limit speed.
4. By inputting the FWD/REV run commands, operation is started at the lower limit speed even if the UP/DOWN command is not input.

When the power supply is turned OFF in the HOLD status, the held output frequency is stored. By inputting the FWD/REV run commands in the HOLD status continuously after the power supply is turned ON, operation is performed at the stored output frequency.

5. When the JOG run command is input during running by UP/DOWN commands, the JOG run command has priority.

### **(12) FJOG command, RJOG command (set value = 12, 13)**

Forward and reverse jog frequency operation is enabled.

Set value = 12 FJOG command: Forward run by jog frequency reference (An-09) at closed.

Set value = 13 RJOG command: Reverse run by jog frequency reference (An-09) at closed.

Notes:

1. When FJOG command or RJOG command is input during running, FJOG command or RJOG command has priority.
2. When both FJOG and RJOG commands are closed for 500ms or more, the inverter stops according to the stopping method selection (Sn-04).
3. FJOG or RJOG command can be set individually.



---

**(13) External faults 1 to 4** (set values = 2X, 3X, 4X, 5X: X is O to F)

When external faults 1 to 4 are input,  $\overline{E}F\overline{S}$  to  $\overline{E}F\overline{B}$  is displayed on the digital operator, and the inverter operates according to combinations of four bits shown in the table below. The hexadecimal equivalent of combinations of four bits show below is set in the 1st digit of the setting value (2X, 3X, 4X, 5X) of external faults 1 to 4.

Bit No.	0	1
0	External fault input: NO - contact input	External fault input: NC - contact input
1	External fault signal: Always detected	External fault signal: Detected during running only
3,2	Selection of processing at external fault detection	00: Ramp to stop (major fault) 01: Coast to stop (major fault) 10: Ramp to stop by bn-04 (major fault) 11: Operation to continue (minor fault)

<Example> External fault 1 is set as follows.  
 : NO - contact input  
 : Signal is always detected  
 : Processing is coast to stop

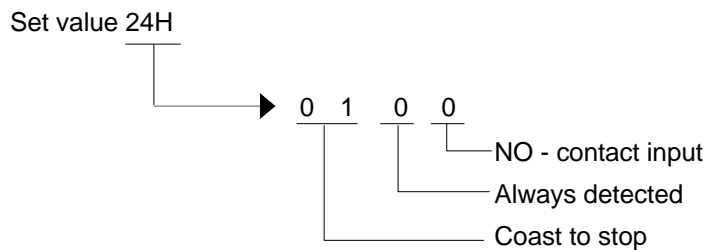

The inverter operates differently as described below when experiencing major faults or minor faults. The digits in the error display  $\overline{E}F\overline{S}$  to  $\overline{E}F\overline{B}$  indicate the terminal numbers in which external faults 1 to 4 are set.

**Major faults**

If an external fault is input, the fault is displayed and the inverter stops according to process selection at external fault detection. Fault contact output relay is output immediately.

**Minor faults**

Fault display blinks only when external fault is input (the display is made for 0.5 second even when input is less than 0.5 second).

## 7.4 MULTI-FUNCTION CONTACT INPUT SELECTION **Sn-15 to -18** (Cont'd)

<Example> External faults 1 to 4 are set to multi-function terminals 1 to 4.  
(Nos. of terminal 5 to 8)

No. of Fault	Multi-function Terminal	Display on Digital Operator	
		(Major Fault)	(Minor Fault)
External Fault 1	Terminal 5	<i>EF5</i> lights (holding)	<i>EF5</i> blinks
External Fault 2	Terminal 6	<i>EF6</i> lights (holding)	<i>EF6</i> blinks
External Fault 3	Terminal 7	<i>EF7</i> lights (holding)	<i>EF7</i> blinks
External Fault 4	Terminal 8	<i>EF8</i> lights (holding)	<i>EF8</i> blinks

Additional Notes of External Faults:

1. External fault reset is enabled in baseblock status.
2. The following shows the priority order of process selection when more than one external fault is input.  
Coast to stop > ramp stop by bn-04 > ramp stop by bn-02.
3. Fault retry is disabled when an external fault is input.

### (14) DC injection braking command (set value = 60)

When DC braking command is input when the inverter stops, DC braking operation is performed. When operation signal or jog operation command is input, the DC braking operation is stopped and the operation is started. (Privileged operation)

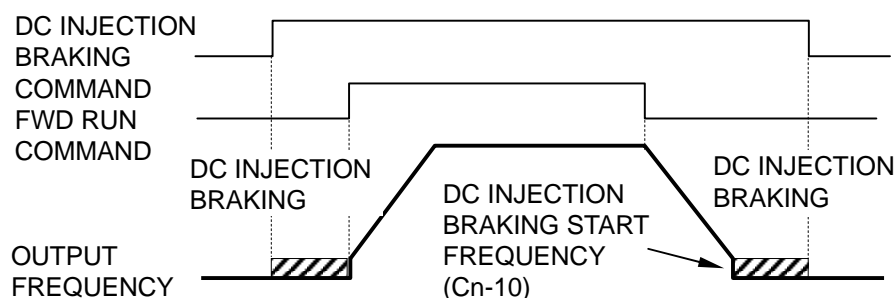

**(15) Search command** (set value = 61,62)

To start the motor during coasting when commercial power supply/inverter changing operation is performed, the motor can be operated without tripping by using the speed search function.

Set value = 61: Speed search starts with the maximum frequency.

Set value = 62: Speed search starts with the frequency reference value when search command is input.

Search commands with set values of 61 and 62 cannot be set at the same time.

By inputting the run command with the search command "closed" during baseblock, speed search starts after shutting down the inverter output for the minimum baseblock time (Cn-40).

Speed search operation starts when inverter output current is larger than the set value of the speed search operation level (Cn-38). The frequency at which inverter output current is smaller is determined as the speed synchronous point: Re-acceleration/deceleration is performed in the set accel/decel time up to the set frequency.

The following shows the time chart where the speed search command is input.

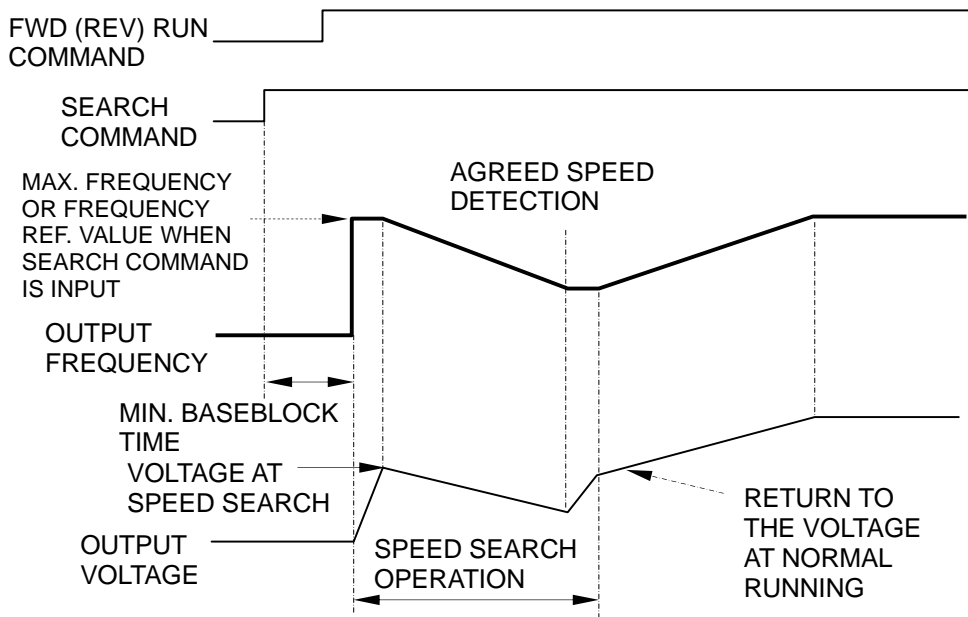

**Notes:**

1. In momentary power loss operation continuation mode, speed search operation is performed beginning with current output frequency, regardless of the existence of search command. After completion of speed search, the operation is performed according to the run command.

## 7.4 MULTI-FUNCTION CONTACT INPUT SELECTION **Sn-15 to -18 (Cont'd)**

- Determine a sequence so that FWD/REV run command enters at the same time or later than search command.

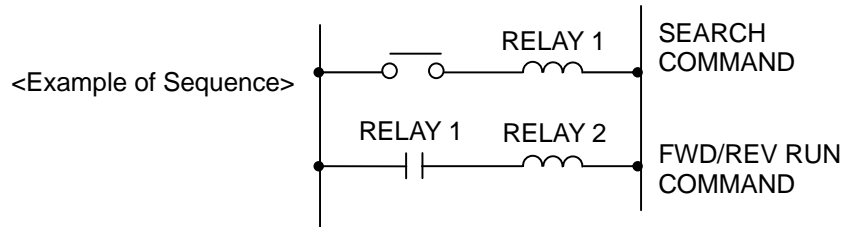

- More than two search commands for set values of 61 and 62 cannot be set.

### (12) Energy-saving operation command (set value = 63)

When energy-saving operation command is input, output voltage is reduced only during agreed frequency and energy-saving operation is performed. The output voltage during energy-saving operation command is the product of normal V/f (Cn-02 to Cn-08) and energy-saving gain (bn-09 initial value 80%). Output voltage attenuates and returns in voltage recovery time.

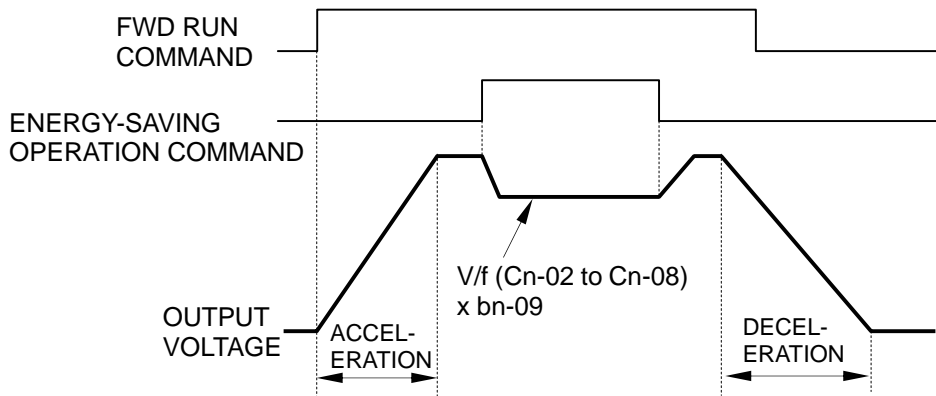

Time Chart - When energy-saving operation command is input

## 7.5 MULTI-FUNCTION ANALOG INPUT SELECTION **Sn-19**

Select the set values shown below for Sn-19.

Set value	Function	Remarks
00	AUX frequency reference*	Used for MASTER/AUX frequency reference selection.
01	Frequency reference gain (F GAIN)	Total gain: Internal gain (bn-05) x F GAIN
02	Frequency reference bias 1 (F BIAS 1)	Total bias: Internal bias (bn-06) + F BIAS 1
03	Frequency reference bias 2 (F BIAS 2) (+ -)	Total bias: Internal bias (bn-06) + F BIAS 2
04	Overtorque detection level	Internal overtorque detection level (Cn-26) ineffective.
05	V BIAS +	V BIAS addition after V/f conversion.
06	Accel/decel time reduction coefficient	Accel/decel time varied by analog input.
07	DC braking current	DC injection braking current varied by analog input. (10V/inverter rated current) Internal DC braking current setting (Cn-11) ineffective.
08	Stall level during running	Stall level during running is set by analog input. Cn-30 becomes ineffective.
09	Frequency reference lower limit	Frequency reference lower limit value is set by analog input. Either Cn-15 set value or analog input whichever is larger becomes effective.
0A	Setting prohibit frequency 4	Setting prohibit frequency is set. The fourth value in addition to frequency values set by Cn-16 to 18 can be set.
0B to 0F	Not used (no function provided)	

\* Not to be used with An-02.

+460 class: V BIAS value 0 to 200V

Note: For combinations of multi-step speed references at set value = 00, refer to pages 85 and 86.

## 7.5 MULTI-FUNCTION ANALOG INPUT SELECTION **Sn-19** (Cont'd)

### Multi-function Analog Input Characteristics

(1) Sn-19 = 0

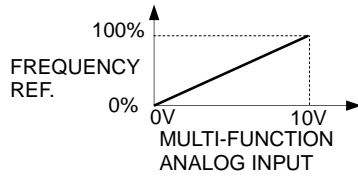

(2) Sn-19 = 1

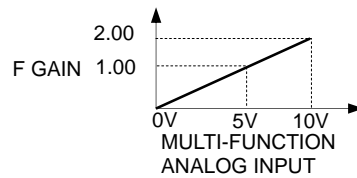

(3) Sn-19 = 2

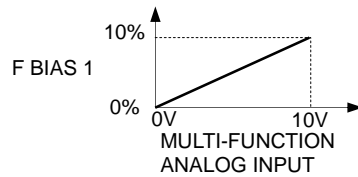

(4) Sn-19 = 3

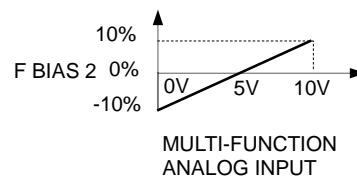

(5) Sn-19 = 4

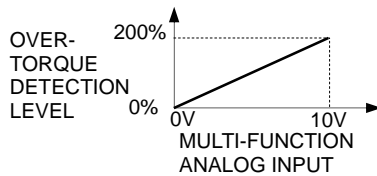

(6) Sn-19 = 5

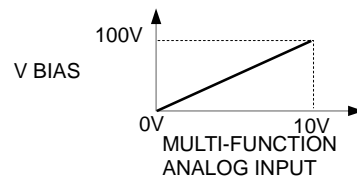

(7) Sn-19 = 6

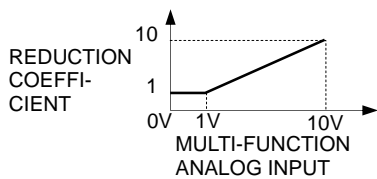

(8) Sn-19 = 7

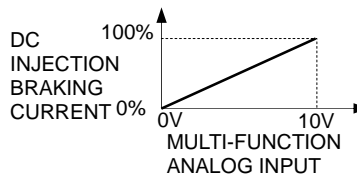

$$\text{Actual accel/decel time} = \frac{\text{Accel/decel time (bn-01 to -04)}}{\text{Reduction coefficient}}$$

(9) Sn-19 = 08

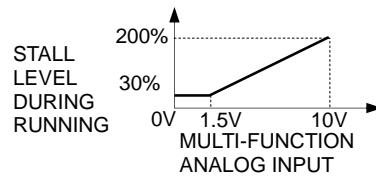

(10) Sn-19 = 09

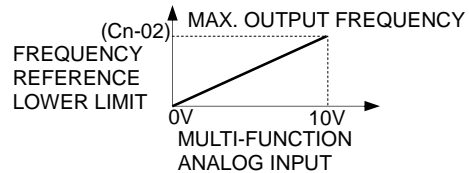

(11) Sn-19 = 0A

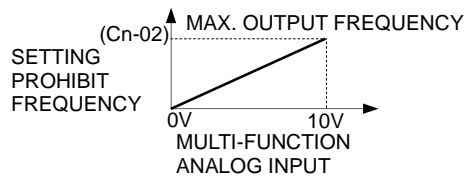

## 7.6 MULTI-FUNCTION CONTACT OUTPUT SELECTION **Sn-20 to -22**

Select the set values shown below for Sn-20 to -22.  
Contact output for 0.1 sec. while detecting signal.

Terminal No.	Sn-□□
Control circuit terminal 9, 10 (Contact output)	20
Control circuit terminal 25, 27 (Open collector output)	21
Control circuit terminal 26, 27 (Open collector output)	22

Set Value	Description	
	Name	Signal Level (Closed)
00	During running	Closed: During running
01	Zero speed	Closed: Zero speed
02	Agreed frequency	Closed: $\left( \begin{array}{c} \text{Frequency ref.} \\ \text{Output} \\ \text{Frequency ref.} \end{array} \right) \leq \text{frequency} \leq \left( \begin{array}{c} \text{Frequency ref.} \\ \text{Output} \\ \text{Frequency ref.} \end{array} \right)$ $\left( \begin{array}{c} \text{Frequency ref.} \\ \text{Output} \\ \text{Frequency ref.} \end{array} \right) \leq \text{frequency} \leq \left( \begin{array}{c} \text{Frequency ref.} \\ \text{Output} \\ \text{Frequency ref.} \end{array} \right)$
03	Agreed frequency setting	Closed: Set value 2 in agreed frequency status and $(Cn-21 - Cn-22) \leq \text{output frequency} \leq (Cn-21 + Cn-22)$
04	Frequency detection	Closed: Output frequency $\leq Cn-21$
05	Frequency detection	Closed: Output frequency $\geq Cn-21$
06	Inverter operation ready	Closed: Inverter operation ready
07	During undervoltage detection	Closed: During undervoltage detection
08	During baseblock	Closed: During inverter output baseblock
09	Frequency reference mode	Open: From control circuit terminal Closed: From operator
0A	Control command	Open: From control circuit terminal Closed: From operator
0B	Overtorque detection	Closed: During overtorque reference missing
0C	Frequency reference missing	Closed: While frequency reference missing
0D	Braking resistor fault	Open: From control circuit terminal Closed: From operator
0E	Fault	Closed: Fault (except CPF 00, CPF 01)
0F	Not used	-



## 7.6 MULTI-FUNCTION CONTACT OUTPUT SELECTION **Sn-20 to -22** (Cont'd)

**(1) Operation** (set value = 0)

The operation contact is "closed" when FWD or REV run command is input, or the inverter outputs voltage.

**(2) Zero-speed** (set value = 1)

The zero-speed contact is "closed" when inverter output frequency is less than the minimum output frequency.

**(3) Agreed frequency** (set value = 2)

This is "closed" when output frequency is within the detection width shown in the figure below.

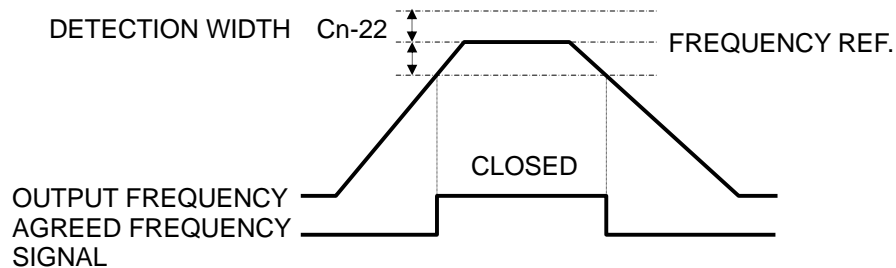

$$(\text{Frequency ref.} - \text{Cn-22}) \leq \text{Output frequency} \leq (\text{Frequency ref.} + \text{Cn-22})$$

Cn-22: Agreed frequency detection width.

**(4) Agreed frequency** (Set value = 3)

This is "closed" when acceleration or deceleration is completed and output frequency is within the detection width shown in the figure below.

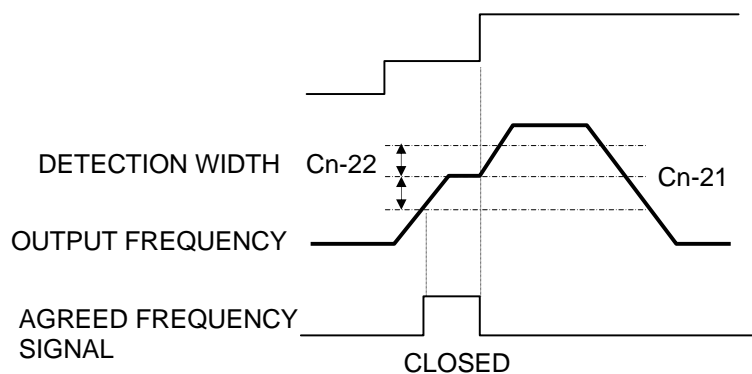

$$(\text{Cn-21} - \text{Cn-22}) \leq \text{Output frequency} \leq \text{Cn-21} + \text{Cn-22}$$

Cn-21: Agreed frequency point.

Cn-22: Agreed frequency detection width.

**(5) Frequency detection (set value = 4)**

This contact is "closed" when output frequency is equal to or less than Cn-21, as shown in the figure below.

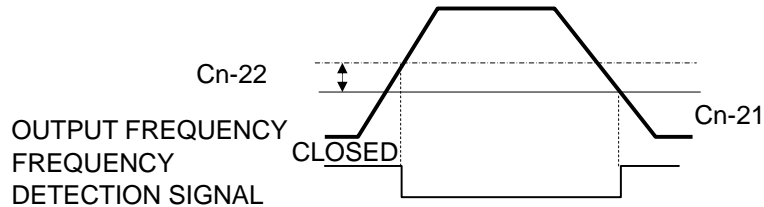

Output frequency  $\leq$  Cn-21

Cn-21: Agreed frequency point.

Cn-22: Agreed frequency detection width.

**(6) Frequency detection (set value = 5)**

This contact is "closed" when output frequency is equal to or greater than Cn-21, as shown in the figure below.

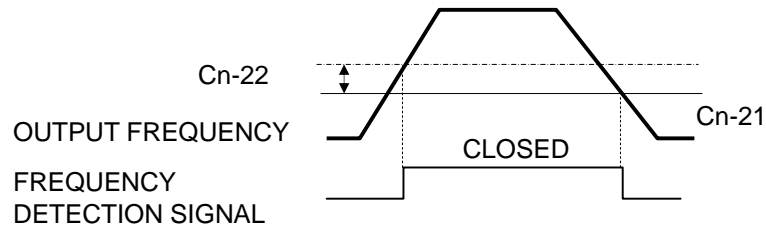

Output frequency  $\geq$  Cn-21

Cn-21: Agreed frequency point.

Cn-22: Agreed frequency detection width.

**(7) Inverter operation ready (set value = 6)**

This is "closed" when the inverter has become ready for operation.

**(8) During undervoltage (UV) detection (set value = 7)**

This contact remains "closed" as long as the inverter is detecting undervoltage.

**(9) During baseblock (set value = 8)**

This contact is always "closed" when inverter output is shut OFF.

**(10) Frequency reference mode (set value = 9)**

This contact is "closed" when the frequency reference mode from the operator is selected.

---

## 7.6 MULTI-FUNCTION CONTACT OUTPUT SELECTION **Sn-20 to -22**(Cont'd)

**(11) Control command** (set value = A)

This contact is "closed" when the control command from the keyboard is selected.

**(12) Overtorque detection** (set value = B)

This contact remains "closed" as long as the inverter is detecting overtorque. Set overtorque detection level in Cn-26 and set overtorque detection time in Cn-27.

**(13) Frequency reference missing** (set value = C)

This is "closed" when frequency reference missing is detected.

**(14) Braking resistor fault** (set value = D)

This is "closed" when the braking resistor is overheated or a fault is detected in the braking transistor.

**(15) Fault** (set value = E)

This contact is "closed" when the inverter detects a major fault. However, in the event of a fault in the watchdog (CPF00) or transmission between the mainframe and operator, the inverter is not operated.

**(16) Not used** (set value = F)

Multi-function contact output not used.

## 7.7 CONTROL CONSTANTS **Cn-□□**

Function	Cn-□□	Data Name	Set Unit	Set Range	Factory Setting
V/f Patten Setting	01	Input voltage	0.1V	150 - 255.0* <sup>1</sup>	220.0 * <sup>2</sup>
	02	Max. output frequency	0.1Hz	50.0 - 400.0	60.0
	03	Max. voltage	0.1V	0.1 - 255.0 * <sup>1</sup>	220.0 * <sup>2</sup>
	04	Max. voltage frequency	0.1Hz	0.1 - 400.0	60.0
	05	Mid. output frequency	0.1Hz	0.1 - 400.0	3.0
	06	Mid. output frequency voltage	0.1V	0.1 - 255.0 * <sup>1</sup>	16.5
	07	Min. output frequency	0.1Hz	0.1 - 400.0	1.5
	08	Min. output frequency voltage	0.1V	0.1 - 255.0 * <sup>1</sup>	11.0 * <sup>2</sup>
Electronic Thermal Reference Current	09	Motor rated current	0.1A	* <sup>3</sup>	3.3 * <sup>4</sup>
DC Injection Braking Function	10	DC braking start frequency	0.1Hz	0.1 - 10.0	1.5
	11	DC braking current	1%	0 - 100	50
	12	DC braking time at stopping	0.1sec	0.0 - 25.5	0.5
	13	DC braking time at starting	0.1sec	0.0 - 25.5	0.0
Frequency Limit Control	14	Frequency reference upper limit	1%	0 - 109	100
	15	Frequency reference lower limit	1%	0 - 109	0
Frequency Prohibited Control	16	Setting prohibit (skip) frequency 1	0.1Hz	0.0 - 400.0	0.0
	17	Setting prohibit (skip) frequency 2	0.1Hz	0.0 - 400.0	0.0
	18	Setting prohibit (skip) frequency 3	0.1Hz	0.0 - 400.0	0.0
	19	Setting prohibit frequency range	0.1Hz	0.0 - 25.5	1.0
Operator Display Change	20	Operator display mode	1	0 - 39999	0
Agreed Speed Detection	21	Agreed frequency	0.1Hz	0.0 - 400.0	0.0
	22	Agreed frequency detection width	0.1Hz	0.1 - 25.5	2.0

## 7.7 CONTROL CONSTANTS **Cn-□□**

Function	Cn-□□	Data Name	Set Unit	Set Range	Factory Setting
Carrier Frequency Adjustment	23	Carrier frequency upper limit	0.1kHz	0.4 - 15.0* <sup>6</sup>	15.0 * <sup>6</sup>
	24	Carrier frequency lower limit	0.1kHz	0.4 - 15.0* <sup>6</sup>	15.0 * <sup>6</sup>
	25	Carrier frequency proportion gain	1	0 - 99	0 * <sup>6</sup>
Overtorque Detection	26	Overtorque detection level	1%	30 - 200	160
	27	Overtorque detection time	0.1sec	0.0 - 25.5	0.1
Stall Prevention	28	Stall prevention level during acceleration	1%	30 - 200	170
	29	Constant HP (kW) area stall prevention	1%	30 - 200	50
	30	Stall prevention level during running	1%	30 - 200	160
Torque Boost Control	31	Motor terminal resistance (Motor phase to phase resistance)	0.001	0.000-65.535	5.732* <sup>4</sup>
	32	Motor iron loss	1W	0 - 65535	64 * <sup>4</sup>
	33	Torque compensation limiter	1V	0 - 50 * <sup>1</sup>	50 * <sup>4</sup>
Simplified Speed Control	34	Motor no load current	1%	0 - 99 * <sup>5</sup>	30
	35	Slip compensation primary delay time	0.1sec	0.0 - 25.5	2.0
Fault Retry	36	No. of auto reset/restart operation	1	0 - 10	0
Corrective Action for Momentary Power Loss	37	Power loss ride-thru time	0.1sec	0.0 - 2.0	0.7 * <sup>4</sup>
Speed Search Control	38	Speed search deactivation current level	1%	0 - 200	150
	39	Speed search decel time	0.1sec	0.1 - 25.5	2.0
	40	Min. baseblock time	0.1sec	0.5 - 5.0	0.5 * <sup>4</sup>
	41	V/f during speed search	1%	10 - 100	100
	42	Voltage recovery time	0.1sec	0.1 - 5.0	0.3

\*1 For 230V class. x2 for 460V class.

\*2 For 230V class. x2 for 460V class.

\*3 Setting range becomes 10 to 200% of inverter rated current.

\*4 Factory settings differ depending on inverter capacity. (Sn-01 set value).

This example shows combination of (1HP 0.75kW) and TECO standard motor 220v 60Hz 1HP 0.75kW. (Refer to the table on pages 62 to 65).

At setting Sn-01, the set value changes to the factory setting. For any application other than TECO standard motors, set the value shown on the nameplate of the motor.

\*5 Motor rated current (Cn-09) becomes 100% level.

\*6 Factory setting and setting range differ depending on inverter capacity. (Sn-01 set value).

---

**(1) Input voltage (Cn-01)**

Set inverter input voltage. (in units of 0.1V).

**(2) V/f constant (Cn-02 to Cn-08)**

Set inverter output frequency/voltage characteristics. (V/f characteristics).

(a) Changing V/f characteristics

Sn-02 = 0 to E: V/f characteristics determined by set value. Settings of Cn-02 to Cn-08 cannot be changed. (Refer to page 66).

Sn-02 = F: Any V/f characteristic can be obtained by the set values of constants Cn-02 to Cn-08.

(b) Voltage values (Cn-03, Cn-06, Cn-08) displayed in the operator depend on the set value of Sn-02 (V/f selection) as follows:

- Sn-02 = 0 to E: Proportional computation is performed with input voltage (Cn-01) as 100%

<Example> When Cn-01 = 220V and V/f pattern Sn-02 = 1, the following display is shown on the operator:

- Cn-03 = 220
- $Cn-06 = 15V \times \frac{220}{200} = 16.5V$
- $Cn-08 = 10V \times \frac{220}{200} = 11V$
- Sn-02 = F: The set value is displayed.

(c) When V/f characteristics are a straight line, the same value as Cn-07 is set in Cn-05. The set value of Cn-06 is disregarded.

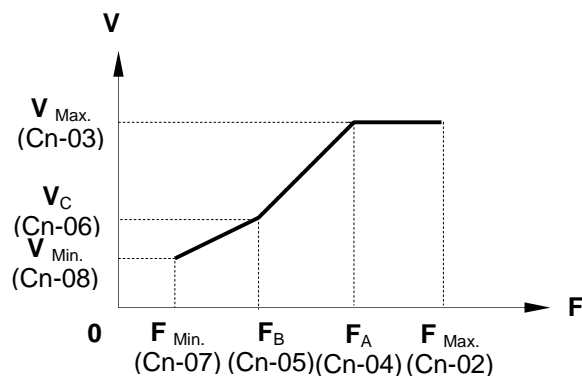

## 7.7 CONTROL CONSTANTS **Cn-□□**. (Cont'd)

Notes:

1. The maximum output voltage is limited by input voltage.
2. When the set values of Cn-02 to Cn-08 do not satisfy the following conditions, a setting error occurs and *OPF10* is displayed. The set value is checked at power ON and switching from PRGM mode to DRIVE mode.  $F_{Max.} \geq F_A > F_B \geq F_{Min.}$
3. Actual output voltage is limited to the following value even if an arbitrary V/f is set as Sn-02 = F. For setting without limit, set Sn-02 = FF. In this case, the inverter may malfunction unless V/f suitable for the motor characteristics is set.

0.5 to 5HP (0.4 to 3.7kW)

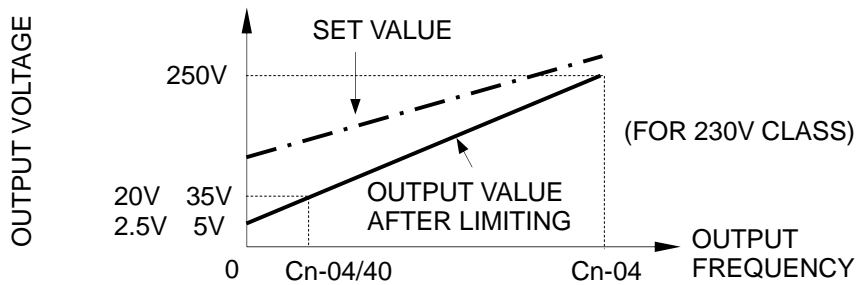

7.5 to 30HP (5.5 to 22kW)

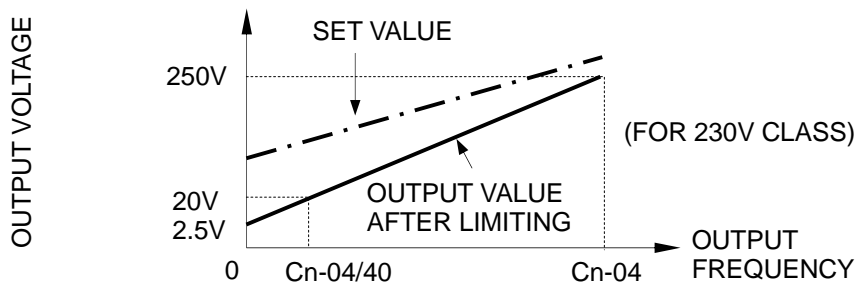

40 to 100HP (30 to 75kW), (40 to 400HP for 460V class)

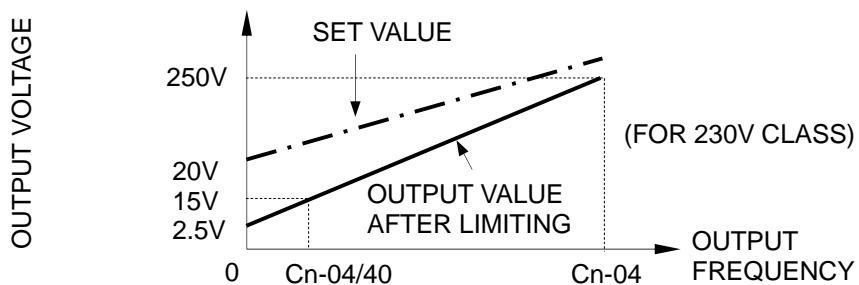

**(3) Motor rated current (Cn-09)**

Set motor rated current by the electronic thermal function in units of 0.1A for motor overload protection. The range of setting is 10% to 200% of inverter rated current. When the 1st digit of Sn-14 is 1, the electronic thermal function is disabled and the motor is not protected from overheating due to overload.

**(4) DC braking start frequency (Cn-10)**

Set a frequency for starting DC braking at deceleration stop in units of 0.1Hz. When a set value is not greater than Cn-07 (minimum output frequency), DC braking is started with the minimum output frequency.

**(5) DC braking current (Cn-11)**

Set DC braking current in units of 1%. Inverter rated current is 100%.

**(6) DC braking time at stopping (Cn-12)**

Set the duration of DC braking at stopping in units of 0.1 second. When a set value is 0, DC braking is not performed, and inverter output is shut OFF at the start of DC braking.

**(7) DC braking time at starting (Cn-13)**

Set the duration of DC braking at starting in units of 0.1 second. When a set value is 0, DC braking is not performed, and acceleration begins with the minimum output frequency.

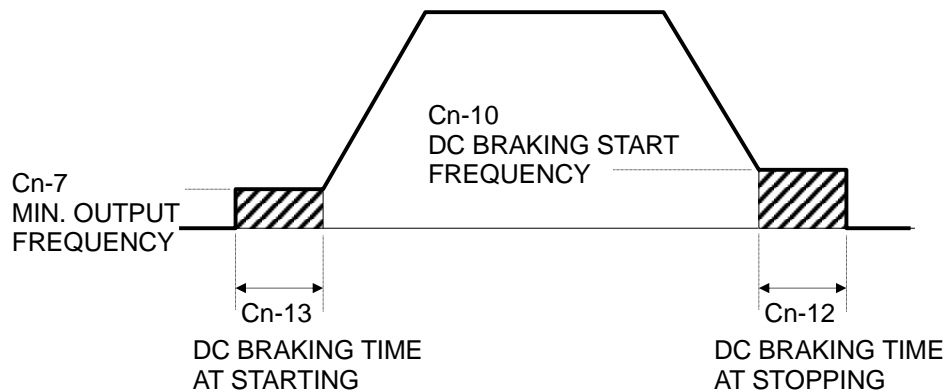

**(8) Frequency reference upper limit (Cn-14)**

Set the upper limit of frequency reference in units of 1%. Cn-02 (maximum frequency) is regarded as 100%.



## 7.7 CONTROL CONSTANTS Cn- □□ . (Cont'd)

### (9) Frequency reference lower limit (Cn-15)

Set the lower limit of frequency reference in units of 1%. Cn-02 (maximum frequency) is regarded as 100%. When the run command is input with a frequency reference of 0, acceleration continues from the minimum frequency to the lower frequency reference limit, and operation continues in the lower frequency reference limit.

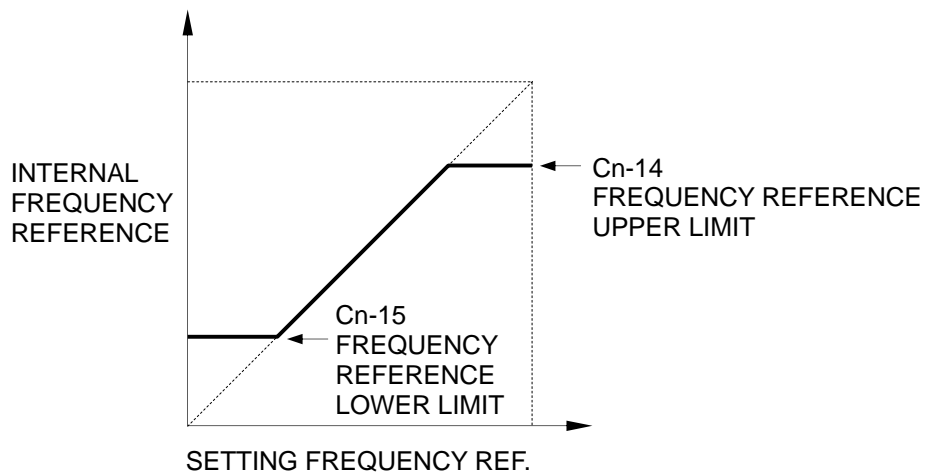

### (10) Setting prohibit (skip) frequencies 1 to 3 (Cn-16 to Cn-18)

Set a setting prohibit frequency in units of 0.1Hz. A set value of 0.0Hz disables this function.

Note: If the setting prohibit frequency ranges overlap, set prohibit (skip) frequency 1 to 3 as shown below:

$$\left( \begin{array}{c} \text{Cn-18} \\ \text{setting prohibit} \\ \text{frequency 3} \end{array} \right) \leq \left( \begin{array}{c} \text{Cn-17} \\ \text{setting prohibit} \\ \text{frequency 2} \end{array} \right) \leq \left( \begin{array}{c} \text{Cn-16} \\ \text{setting prohibit} \\ \text{frequency 1} \end{array} \right)$$

**(11) Setting prohibit (skip) frequency range (Cn-19)**

Set the range of setting prohibit (skip) frequency in units of 0.1Hz. The range of the setting prohibit (skip) frequency is determined as follows, depending on combinations with Cn-16 to Cn-18.

$Cn-16 \text{ to } Cn-18 - Cn-19 \leq \text{the range of the setting prohibit frequency} \leq Cn-16 \text{ to } Cn-18 + Cn-19$ .

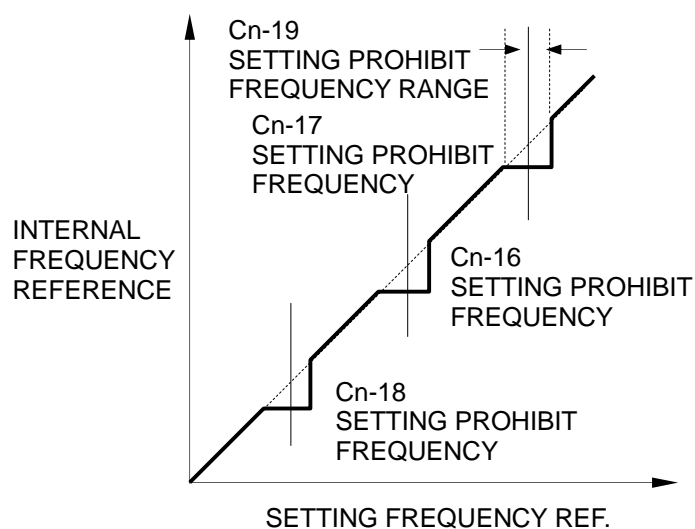

Note: Constant speed operation is prohibited in the setting prohibit frequency range. Output frequency does not jump during acceleration or deceleration, which is performed smoothly.

## 7.7 CONTROL CONSTANTS Cn-□□. (Cont'd)

### (12) Operator display mode (Cn-20)

The setting unit of frequency references 1 to 8 and jog frequency reference depends on the set value of operator display mode (Cn-20) as follows:

Cn-20	Setting / Reading Unit
0	Units of 0.01Hz
1	Units of 0.01%
2 to 39	Set in the units of r/min (0 to 39999). $r/min = 120 \times \text{frequency reference (Hz)} / Cn-20$ (Set the number of motor poles in Cn-20).
40 to 39999	The position of decimal point is set by the value of the 5th digit of Cn-20. Value of 5th digit = 0: Displayed as XXXX Value of 5th digit = 1: Displayed as XXX.X Value of 5th digit = 2: Displayed as XX.XX Value of 5th digit = 3: Displayed as X.XXX A set value of 100% frequency is determined by the 1st digit to 4th digit of Cn-20. Example 1: When the set value of 100% speed is 200.0, Cn-20 = 12000 is set. 100% speed is displayed as 200.0 at Cn-20 = 12000. 60% speed is displayed as 120.0 Example 2: When the set value of 100% speed is 65.00, Cn-20 = 26500 is set. 60% speed is displayed as 39.00 at Cn-20 = 26500.

**(13) Agreed frequency (Cn-21)**

Set an agreed frequency point in units of 0.1Hz.

**(14) Agreed frequency detection width (Cn-22)**

Set an agreed frequency detection width in units of 0.1Hz. The relationship with the multi-function contact outputs are shown in the four figures below [(a) to (d)].

(a) Agreed frequency (set value of multi-function contact output = 2)

This is "closed" when output frequency is within the detection width shown in the following figure.

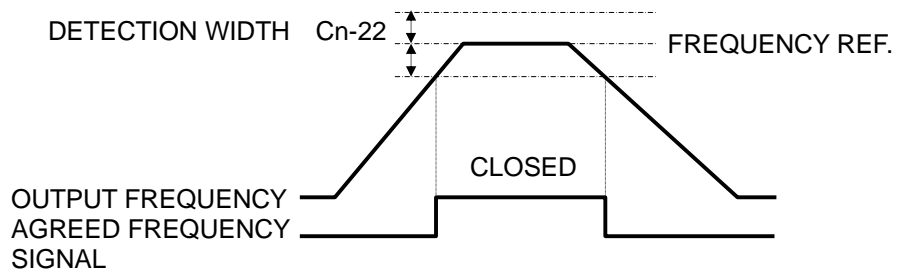

$$(\text{Frequency ref.} - \text{Cn-22}) \leq \text{Output frequency} \leq (\text{Frequency ref.} + \text{Cn-22})$$

Cn-21: Agreed frequency point.

Cn-22: Agreed frequency detection width.

(b) Agreed frequency (set value of multi-function contact output = 3)

This is "closed" when acceleration or deceleration is completed and output frequency is within the detection width shown in the figure below.

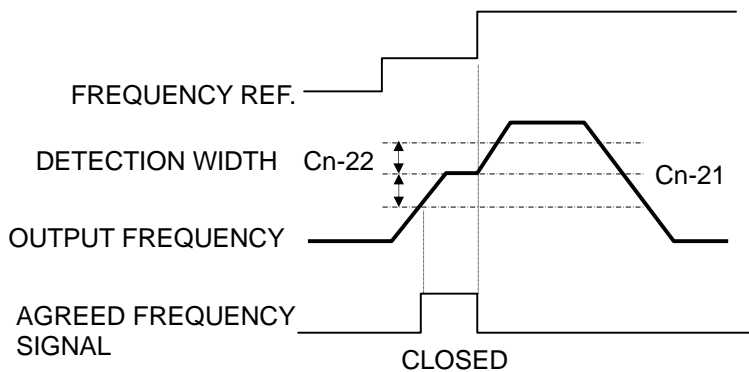

$$(\text{Cn-21} - \text{Cn-22}) \leq \text{Output frequency} \leq (\text{Cn-21} + \text{Cn-22})$$

Cn-21: Agreed frequency point.

Cn-22: Agreed frequency detection width.

## 7.7 CONTROL CONSTANTS Cn-□□. (Cont'd)

- (c) Frequency detection contact (set value of multi-function contact output = 4)

This contact is "closed" when output frequency is equal to or less than Cn-21, as shown in the figure below.

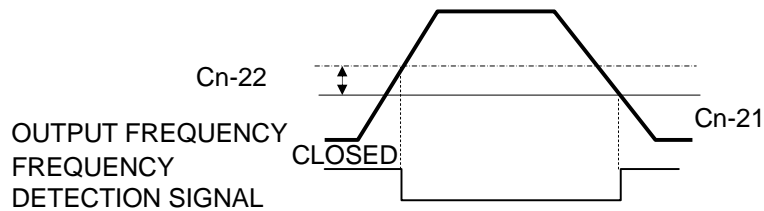

Output frequency  $\leq$  Cn-21

Cn-21: Agreed frequency point.

Cn-22: Agreed frequency detection width.

- (d) Frequency detection contact (set value of multi-function contact output = 5)

This contact is "closed" when output frequency is equal to or more than Cn-21, as shown in the figure below.

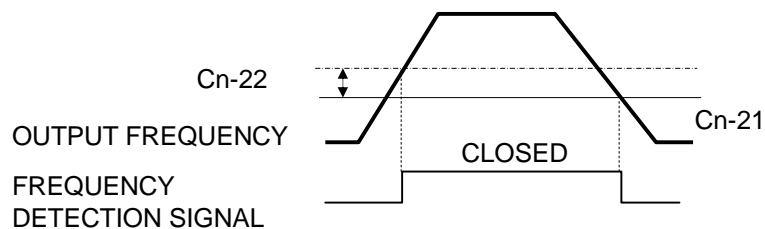

Output frequency  $\geq$  Cn-21

Cn-21: Agreed frequency point.

Cn-22: Agreed frequency detection width.

**(15) Carrier frequency upper/lower limit, proportion gain (Cn-23 to Cn-25)**

The relationship between output frequency and carrier frequency is determined as follows from the set values of Cn-23 to Cn-25.

(a) For constant carrier frequency (set value of Cn-23):

Set 0 in Cn-25 and set the same value in Cn-23 and Cn-24.

(b) For carrier frequency: Carrier frequency changes according to Cn -23 to Cn-25 set values and output frequency as shown below.

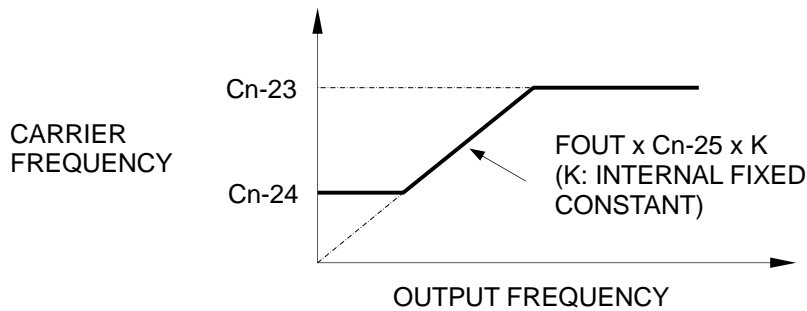

$\square P E I I$  is displayed in the following cases:

- ① Cn-25 > 6 and Cn-24 > Cn-23
- ② Cn-23 > 5kHz and Cn-24  $\leq$  5kHz

**(16) Overtorque detection level (Cn-26)**

Set overtorque level in units of 1%. Inverter rated current is regarded as 100%.

**(17) Overtorque detection time (Cn-27)**

Set overtorque detection time in units of 0.1 second.

**(18) Stall prevention level during acceleration (Cn-28)**

Set stall prevention level during acceleration in units of 1%. Inverter rated current is regarded as 100%.

## 7.7 CONTROL CONSTANTS **Cn-□□**. (Cont'd)

### (19) Constant HP (kW) area stall prevention limiter (Cn-29)

Set constant HP (kW) area stall prevention level in units of 1%. Inverter rated current is regarded as 100%.

The function of stall prevention during acceleration automatically extends acceleration according to load status (inverter output current), thus preventing the motor from stalling during acceleration. The stall prevention level during acceleration in a constant output area is reduced as follows:

When the 1st digit of Sn-10 is 1, the output frequency increases at the rate determined by acceleration time:

$$\text{Acceleration stall prevention level of constant output area} = \frac{\text{Acceleration stall prevention level (Cn-28)} \times \text{Maximum voltage frequency (Cn-04)}}{\text{Output frequency}}$$

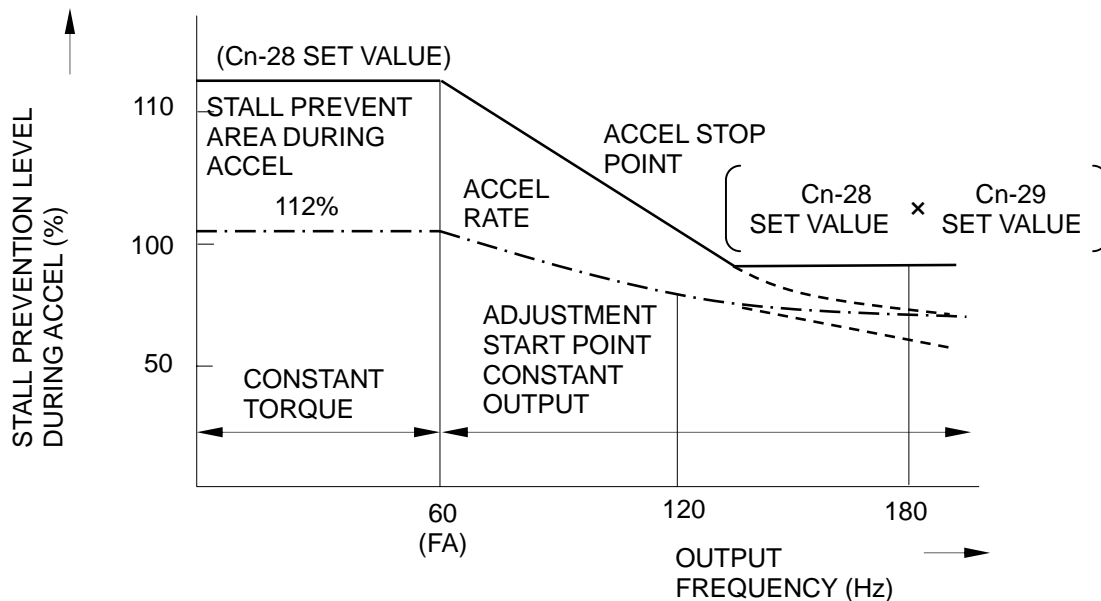

**(20) Stall prevention level during running (Cn-30)**

Set a proportion as a stall prevention level during running in units of 1%. Inverter rated current is regarded as 100%

Stall prevention during running starts deceleration when the output current is greater than the setting value of Cn-30 during agreed frequency for more than 100ms. The inverter decelerates as long as the output current exceeds the setting value of Cn-30 (stall prevention level during running). When the output current goes below the setting value, the inverter reaccelerates. The deceleration time selected in the 4th digit of Sn-10 is taken.

Even during stall prevention while running, stall prevention during deceleration and stall prevention during acceleration are enabled.

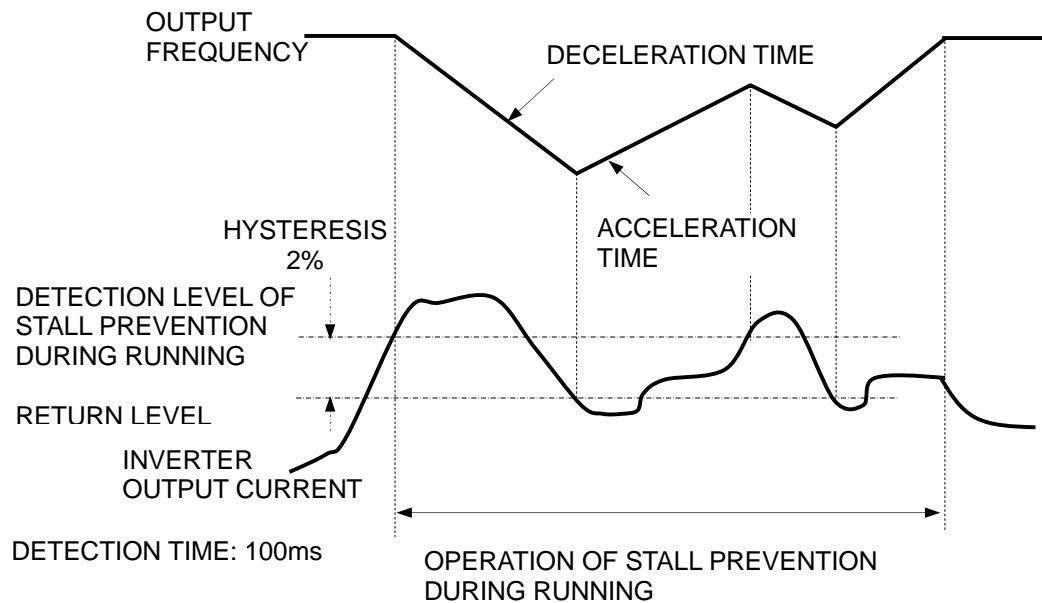



## 7.7 CONTROL CONSTANTS Cn-□□. (Cont'd)

### (21) Motor no-load current (Cn-34)

Set motor no load current in units of 1%. Motor rated current (Cn-09) is regarded as 100%.

When the output current of the inverter is larger than motor no-load current (Cn-34), the output frequency of the inverter is compensated.

The amount of frequency compensation is determined by the formula below.

The maximum voltage frequency (Cn-04) is 100% level.

If the output current is compensated for by the motor rated slip (bn-08).

If frequency reference is equal to or smaller than minimum output frequency (Cn-07) or motor is in a regeneration mode, slip compensation is not performed.

Amount of output frequency compensation =

$$\left( \frac{\text{Motor rated slip}}{\text{Motor rated current} - \text{Motor no-load current}} \times \left( \text{Output current} - \text{Motor no-load current} \right) \right)$$

Motor rated current: Cn-09

Motor no load current: Cn-34

Motor rated slip: bn-08

The amount of output frequency compensation in a constant torque area and a constant output area is shown in the figure below.

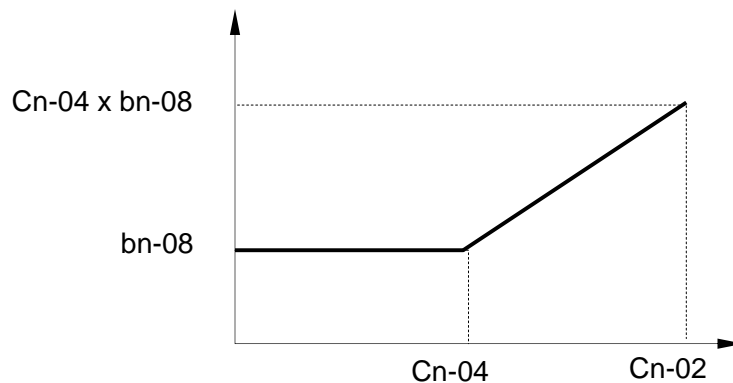

### (22) Slip compensation primary delay time (Cn-35)

Set slip compensation primary delay time in units of 0.1 second.

### (23) No. of auto reset/restart operation (Cn-36)

Set the number of auto reset/restart operation. Setting of zero causes no auto reset/restart operation.

Each time one of these faults occur: OC, OV, OL1, OL2, OL3, OH, UV1 (OC, GF, OV, rr or UV1), one is added to the number of auto reset/restart operation, and auto reset/restart operation is performed according to the following procedure. However, auto reset/restart operation is not performed in the following case:

- ① When operation not continued at momentary power loss (3rd digit of Sn-11 = 0) is specified, UV1 fault is not automatically reset.
- ② When OC or OV fault occurs due to external fault during deceleration stop or DC injection braking stop, inverter output is shut OFF.  
The number of auto reset/restart operation is cleared to zero when:
  - ① No fault occurs for 10 minutes or more.
  - ② A fault reset signal is input from control circuit terminals or digital operator.

#### Auto reset/restart operation

- ① When a fault is detected, inverter output is shut OFF for the minimum baseblock time (Cn-40). During shut OFF of inverter output, a fault occurring in the operator is displayed.
- ② When the minimum baseblock time (Cn-40) elapses, the fault is automatically reset, and speed search operation is performed with the output frequency at the time of the fault.
- ③ When the total number of faults exceeds the number of auto restart attempts (Cn-36), automatic reset is not performed and inverter output is shut OFF. At this time, fault contact output is output.

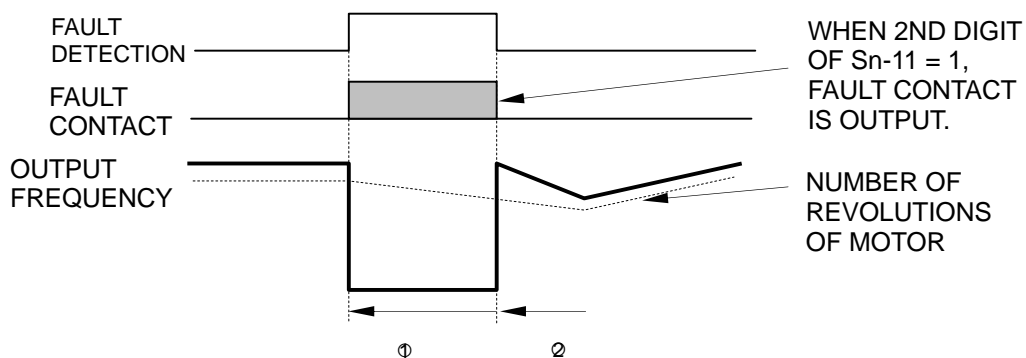

### (24) Power loss ride-thru time (Cn-37)

Set in units of 0.1 second. The initial value depends on the inverter capacity.

## 7.7 CONTROL CONSTANTS Cn-□□. (Cont'd)

### (25) Speed search deactivation current level (Cn-38)

When inverter output current immediately after power recovery is larger than the set value of Cn-38, speed search operation is started. When inverter output current is smaller than the set value of Cn-38, the frequency is interpreted as a speed synchronization point and acceleration or deceleration is performed again up to a specified frequency.

### (26) Speed search decel time (Cn-39)

Set deceleration time during speed search in units of 0.1 second. A setting of 0.0 second causes no speed search.

### (27) Minimum baseblock time (Cn-40)

On detecting momentary power loss, the inverter shuts OFF output and maintains the baseblock state for a given time. Set a time in Cn-40 when residual voltage is expected to be almost zero.

When momentary power loss time is longer than the minimum baseblock time, speed search operation is started immediately after power recovery.

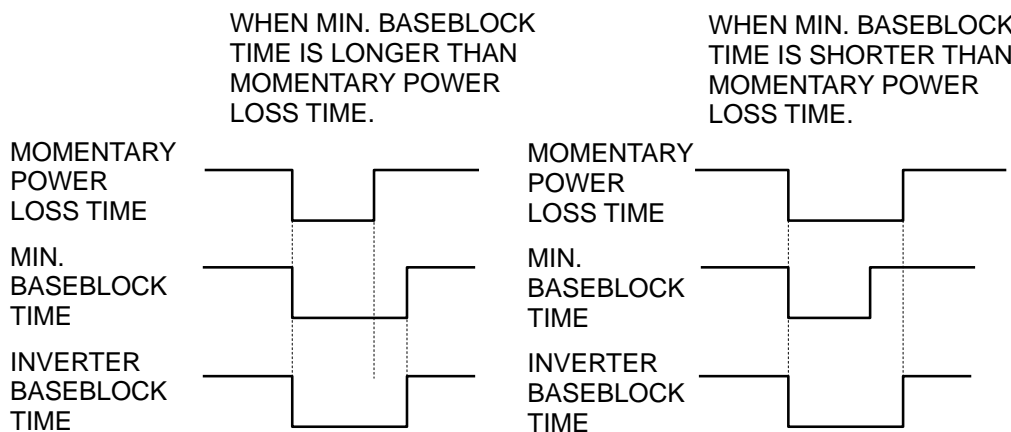

### (28) V/f during speed search (Cn-41)

To ensure that a fault such as OC does not occur during speed search operation, V/f must be reduced during speed search operation, as compared with that during normal operation. Set V/f during speed search as follows by the set value of Cn-41:

$$V/f \text{ during speed search} = V/f \text{ at normal operation} \times Cn-41$$

### (29) Voltage recovery time (Cn-42)

Set in Cn-42 the time between completion of speed search operation and return to V/f at normal operation. The setting of voltage recovery time is set as follows:

230V class: Time required to raise voltage from 0 to 230V

460V class: Time required to raise voltage from 0 to 460V

## 7.8 MONITOR DISPLAY Un-□□ .

Items to be monitor displayed differ as follows, according to Un-xx.

Un-□□	Monitor Item	Display Example
01	Frequency reference	60.0 * <sup>2</sup>
02	Output frequency	60.0
03	Output current	12.5A
04	Output voltage	200V
05	DC voltage	Pn 310
06	Output power (± display) * <sup>1</sup>	12.5 * <sup>3</sup>
07	Input terminal status	* <sup>4</sup>
08	Output terminal status	* <sup>5</sup>
09	LED lamp check	00000
10	PROM No.	* <sup>6</sup>

\*1 + is not displayed.

\*2 Display of frequency reference (Un-01).

Frequency reference is displayed with five significant digits.

< Example >

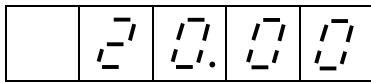

\*3 Display of output power (Un-06).

Output power is displayed in units of 0.1kW.

< Example >

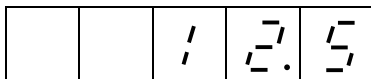

\*4 Display of input terminal status (Un-07).

Input terminal status is displayed.

<Example> External terminals 1, 3, 5 and 6: open

External terminals 2, 4, 7 and 8: closed

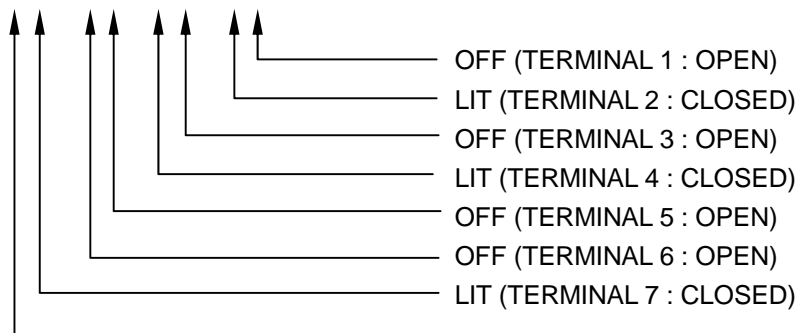
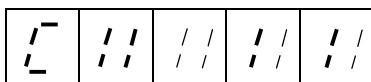

---

LIT (TERMINAL 8 : CLOSED)

---

## 7.8 MONITOR DISPLAY Un-□□. (Cont'd)

\*5 Display of output terminal status (Un-08).

Output terminal status is displayed.

< Example > Control circuit terminals 9 - 10: closed

Control circuit terminals 25 - 27, 26 - 27: open

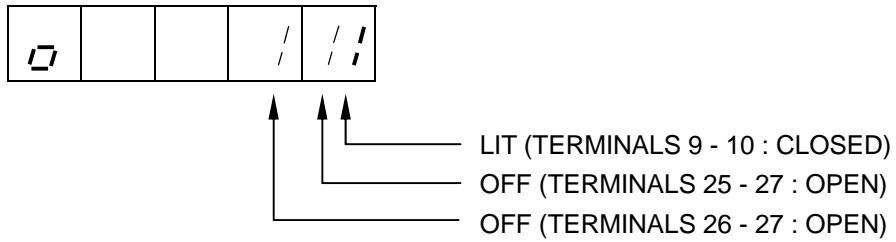

\*6 Display of PROM No. (Un-10).

PROM No. is displayed

< Example > PROM No. is SD72006



## 8. FAULT DISPLAY AND TROUBLESHOOTING

The GA7200 has protection functions and warning self-diagnosis functions. If a fault occurs, the protection functions operate to shut OFF the inverter output and the motor coasts to stop, at the same time, the fault contact signal (terminal ⑱-⑳,⑲-㉑) is output.

### A). PROTECTIVE FUNCTIONS AND TROUBLESHOOTING

Protective Function		Explanation	Monitor Display	Fault Cont. Output
Low voltage protection	Main circuit low voltage	When the inverter power voltage drops, torque becomes insufficient and motor is overheated.	U <sub>U</sub> 1 (UV1)	Operation
	Momentary power loss protection	Inverter output is stopped when the main circuit DC voltage becomes lower than the low voltage detection level for 15ms or longer, or about 2 seconds or longer if the momentary power loss ride-thru function is used. Detection level: Approximately 210V or less for 230V class and 420V or less for 460V class		
	Control circuit low voltage	The inverter output is shut OFF when the control circuit voltage drops below the low voltage level.	U <sub>U</sub> 2 (UV2)	Operation
	Main circuit soft charge contactor def.	The inverter output is shut OFF when no answer is received back from the main circuit soft-start contactor.	U <sub>U</sub> 3 (UV3)	
Overcurrent protection		The inverter output is shut OFF when the inverter output current becomes approx. 200% above the inverter rated current.	O <sub>C</sub> (OC)	Operation
Ground fault protection		The inverter output is shut OFF when a ground fault occurs at the inverter output side and the ground fault current exceeds approximately 50% of the inverter rated current.	G <sub>F</sub>	Operation
Overvoltage protection		The inverter output is shut OFF when the main circuit DC voltage becomes excessive because of regeneration energy caused by motor deceleration and negative load. Detection: Approx. 800V for input voltage set 400V and above level: Approx. 700V for input voltage set 400V or less Approx. 400V for 200V class	O <sub>V</sub> (OV)	Operation
Fuse blown		The inverter output is shut OFF when the main circuit transistor fails. The fuse clears to prevent wiring from being by the short-circuit current.	F <sub>U</sub> (FU)	Operation
Cooling fin overheat		The inverter output is shut OFF when the ambient temperature rises and the heat sink fin reaches 90 °C. Please check for a defective cooling fan or clogged filter.	O <sub>H</sub> (OH)	Operation
Overload protection	Motor	Inverter output is stopped when motor overload is detected by the electronic thermal overload in the inverter. Either an inverter duty constant-torque specialized motor or general-purpose motor can be selected. If more than one motor is driven, overload protection should be disabled. Use a thermal relay or thermal protector for each motor.	O <sub>L</sub> 1 (OL1)	Operation
	Inverter	The inverter output is shut OFF when the electronic thermal overload reaches or exceeds the inverse time limit of 112% of the inverter's rated current. Maximum rated overload: 150%, 1 min.	O <sub>L</sub> 2 (OL2)	Operation
	Overtorque detection	The motor operates according to a preset mode when the inverter output current exceeds the overtorque detection level. This function is used to protect the machine or to monitor the output torque.	O <sub>L</sub> 3 (OL3)	Operation
Braking transistor fault		Inverter output is shut OFF when an error occurs in the braking transistor.	r <sub>r</sub> (rr)	Operation
Braking resistor overheat		For 20HP(15kW) or less (200V), 20HP (15kW) or less (400V), an optional dedicated resistor can be installed. The resistor is monitored by the electronic thermal switch for overheating. The inverter output is shut OFF when a specified temperature is reached.	r <sub>H</sub> (rH)	Operation
External fault signal input		When an external alarm signal is input, the inverter operates according to a preset stop method (coast to stop, ramp stop, or continuous operation)	EF3 to EF8 E <sub>F</sub>	Operation
Control circuit fault, option fault		The inverter output is shut OFF when a transmission error occurs in the control circuit or a component fails. The inverter output is also shut OFF when a specialized option such as the digital operator is not properly connected.	C <sub>P</sub> F02 C <sub>P</sub> F05 C <sub>P</sub> F06 C <sub>P</sub> F07 C <sub>P</sub> F08 C <sub>P</sub> F09 C <sub>P</sub> F10 C <sub>P</sub> F11	Operation
Communication error		When any communication error between communication interface card SC-C, (option) and master controller occurs, the inverter operates according to a preset stop method (coast to stop, ramp stop, or continuous operation).	B <sub>U</sub> S (BUS)	Operation

---



The warning and self-diagnosis functions do not operate fault contact output (except OH2 warning function) and returns to the former operation status automatically when the factor is removed. The fault display and troubleshooting are provided as shown in the table below.

Error Causes	Action to be taken
<ul style="list-style-type: none"> <li>● Inverter capacity is too small.</li> <li>● Voltage drop due to wiring.</li> <li>● Inverter power voltage selection is wrong.</li> <li>● A motor of large capacity (11kW or greater) connected to the same power system has been started.</li> <li>● Rapid acceleration with generator power supply</li> <li>● Operation sequence when power is OFF</li> <li>● Defective electromagnetic contactor</li> </ul>	<ul style="list-style-type: none"> <li>● Check the power capacity and power system.</li> <li>● UV display appears when the inverter power is turned OFF while operation signal is input. Remove the power after stopping the inverter. (Set the third and fourth bits of Sn-04 = 01).</li> </ul>
<ul style="list-style-type: none"> <li>● Extremely rapid accel/decel</li> <li>● Motor on/off switching at the inverter output side</li> <li>● Short-circuit or ground fault at the inverter output side</li> <li>● Motor of a capacity greater than the inverter rating has been started</li> <li>● High-speed motor or pulse motor has been started.</li> </ul>	<p>Transistor error may occur. Investigate the error cause, correct it, then restart.</p>
<ul style="list-style-type: none"> <li>● Motor dielectric strength is insufficient.</li> <li>● Load wiring is not proper.</li> </ul>	<p>Check for ground fault in motor or load wiring.</p>
<ul style="list-style-type: none"> <li>● Overvoltage</li> <li>● Insufficient deceleration time</li> <li>● Regenerative load (Motor is turned by the load).</li> <li>● High input voltage compared to motor rated voltage</li> </ul>	<p>If braking torque is not proper, extend the decel time or use a braking resistor. (If braking resistor is already installed, verify that Sn-10, 2nd digit = 1).</p>
<ul style="list-style-type: none"> <li>● Repeated overcurrent protection (OC)</li> <li>● Repeated overload protection (OL2) power reset</li> <li>● Rapid deceleration in excess excitation (improper V/f characteristic setting)</li> <li>● External noise</li> </ul>	<p>Correct the cause, check the main circuit transistor, replace the fuse, then restart.</p>
<ul style="list-style-type: none"> <li>● Defective cooling fan</li> <li>● Ambient temperature rise</li> <li>● Clogged filter</li> </ul>	<p>Replace the cooling fan and clean the filter. Ambient temperature: 104°F (40°C) or less for enclosed type 122°F (50°C) or less for open chassis</p>
<p>Overload, low speed operation or extended acceleration time, improper V/f characteristic setting</p>	<p>Investigate the cause of overload and review the operation pattern, V/f characteristic, and motor/inverter capacities. (If inverter is repeatedly reset after an overload occurs, the inverter may fault. Investigate and correct the cause of overload.)</p>
<p>Motor Current exceeds the preset value because of machine error or overload.</p>	<p>Check the use of the machine. Correct the overload cause or set a higher detection level which is within the allowable range.</p>
<ul style="list-style-type: none"> <li>● Insufficient resistance of braking resistor</li> <li>● Short-circuit or ground fault in braking resistor</li> </ul>	<p>Review the resistance of the braking resistor and braking duty cycle. Change the resistance or increase the inverter capacity.</p>
<ul style="list-style-type: none"> <li>● Frequent operation stop</li> <li>● Long-time continuous regeneration</li> <li>● Rapid deceleration</li> </ul>	<p>Shorten deceleration time or review the braking torque and brake duty cycle (%ED). Use optional braking resistor or braking unit.</p>
<p>External fault condition occurred.</p>	<p>Correct the cause of the fault input. See Un-07 for the state of input signal.</p>
<ul style="list-style-type: none"> <li>● External noise</li> <li>● Excess vibration or shock</li> <li>● CPF 02: Control circuit fault</li> <li>● CPF 03: NVRAM (SRAM) fault</li> <li>● CPF 04: NVRAM BCC Code error</li> <li>● CPF 05: AD converter fault in CPU</li> <li>● CPF 06: option card fault</li> <li>● Err: Parameter setting error</li> </ul>	<ul style="list-style-type: none"> <li>● Check data in Sn-01 and Sn-02. Record all data, then use Sn-03 for initializing.</li> <li>● Turn off power, then turn on again. If error is persistent, contact your local distributor or TECO representative.</li> </ul>
<ul style="list-style-type: none"> <li>● External noise</li> <li>● Excessive vibration or shock</li> <li>● Poor connection</li> </ul>	<ul style="list-style-type: none"> <li>● Check data in Sn-01 and Sn-02. Record all data, then use Sn-03 for initializing.</li> <li>● Turn OFF power, then turn ON again. If error is persistent, contact your local distributor or TECO representative.</li> <li>● Check for communication cable between communication interface card (SC-C) and master controller.</li> </ul>

## B.) Warning and Self-Diagnosis Functions

Protective Function		Explanation	Monitor Display	Fault Cont. Output
Low-voltage protection ( main circuit voltage ) ( insufficient )		Monitor display appears if low voltage protection conditions such as a drop in main circuit voltage or momentary power loss occur while the inverter output is OFF.	<i>UV</i> (UV) (Blink)	Non operation
High voltage protection		Monitor display appears when the main circuit DC voltage rises above the detection level while the inverter output is OFF.	<i>OV</i> (OV) (Blink)	Non operation
Cooling fin overheat warning		Monitor display appears when a separate thermal protector contact is input to the external terminal.	<i>OH2</i> (OH2) (Blink)	Non operation
Overtorque detection		This function is used to protect the machine and to monitor the inverter output torque. The inverter output reacts in a preset manner when the inverter output current exceeds the overtorque detection level. The monitor display blinks when "operation continue" is preset.	<i>OL3</i> (OL3) (Blink)	Non operation
Stall prevention ( Accel/decel is accomplished with maximum capacity of the inverter without tripping on over-current or overvoltage )	During acceleration	Inverter acceleration is stopped when 170% or more of the inverter rated current is required by the load. This prevents overload protection (OL2) or overcurrent (OC) from occurring. When current is reduced to less than 170%, acceleration is enabled.	-	Non operation
	During normal operation	Output frequency is decreased when 160% of the inverter rated current or greater is required by the load. This prevents motor and inverter overload (OL1, OL2). When current is reduced below 160%, inverter acceleration is enabled.		
	During deceleration	Deceleration is stopped when the DC voltage is caused to rise by motor regenerative energy. This prevents overvoltage trips (OV). When DC voltage decreases, deceleration to the set value resumes.		
Simultaneous normal and reverse rotation commands		When forward and reverse rotation commands are simultaneously detected for a period of time exceeding 500ms, the inverter is stopped according to the preset stop method.	(EF) (Blink)	Non operation
External fault signal input (Minor failure)		It is indicated on the monitor when the mode after external signal input is set to "operation continue."	<i>EF</i> EF3 (Blink) EF8	Non operation
External baseblock signal input (Minor failure) ( main circuit transistor ) ( instantaneous shut off )		When an external baseblock signal is input, the motor coasts to a stop. When the external base block signal is removed, the inverter output is immediately turned on at the previously set frequency.	<i>bb</i> (BB) (Blink)	Non operation
Invalid parameter setting		When an invalid parameter is set, it is indicated on the monitor at power up or when the inverter is changed from the PRGM mode to the DRIVE mode.	<i>OPF01</i> <i>OPF11</i>	Non operation
Communication error		When any communication error between communication interface card SC-C, (option) and master controller (PLC) occurs and a preset stop method of the inverter is set to "continuous operation," a monitor display blinks.	<i>bUS</i> (BUS) (Blink)	Non operation
Communication ready		When the inverter with communication interface card SC-C (option) does not receive correct data from master controller (PLC), " " is displayed.	<i>CALL</i> (CALL)	Non operation
Digital operator communication error	Digital operator communication error 1		<i>CPFD0</i>	Non operation
	Digital operator communication error 2		<i>CPFD1</i>	

Error Causes	Action to be taken
<ul style="list-style-type: none"> <li>● Input voltage drop</li> </ul>	Check the main circuit DC voltage in Un-xx. If the voltage is low, adjust the input voltage.
<ul style="list-style-type: none"> <li>● Input voltage rise</li> </ul>	Check the main circuit DC voltage in Un-xx. If the voltage is high, adjust the input voltage.
<ul style="list-style-type: none"> <li>● Overload</li> <li>● Cooling fan fault</li> <li>● Ambient temperature rise</li> <li>● Clogged filter</li> </ul>	Replace the cooling fan and clean the filter. Ambient temperature: 104°F (40°C) or less for enclosed type 122°F (50°C) or less for open chassis
<ul style="list-style-type: none"> <li>● Motor current exceeded the set value because of machine fault or overload.</li> </ul>	Check the driven machine and correct the cause of the fault or set to a higher value.
<ul style="list-style-type: none"> <li>● Insufficient power for accel/decel</li> <li>● Overload</li> <li>● Phase loss</li> </ul>	<ul style="list-style-type: none"> <li>● Set proper accel/decel time for smooth operation.</li> <li>● For stall prevention during normal operation, lighten the load or increase inverter capacity.</li> </ul>
<ul style="list-style-type: none"> <li>● Operation sequence error</li> <li>● 3-wire/2-wire selection error</li> </ul>	<ul style="list-style-type: none"> <li>● Recheck the control sequence.</li> <li>● Recheck system constants (Sn-15 to -18).</li> </ul>
<ul style="list-style-type: none"> <li>● External fault conditions set-up</li> </ul>	Take appropriate measurements for the cause of external fault input.
<p style="text-align: center;">—</p>	<p style="text-align: center;">—</p>
<ul style="list-style-type: none"> <li>● Invalid parameter setting</li> <li>● OPE01: Inverter KVA setting (Sn-01) error.</li> <li>● OPE02: Parameter setting range error.</li> <li>● OPE03: Multi-function contact input setting error.</li> </ul>	<ul style="list-style-type: none"> <li>● Review the parameter setting range and conditions.</li> </ul>
<ul style="list-style-type: none"> <li>● External noise</li> <li>● Excessive vibration or shock</li> <li>● Poor connection</li> </ul>	<ul style="list-style-type: none"> <li>● Check data in Sn-01 and Sn-02. Record all data, then use Sn-03 for initializing.</li> <li>● Turn OFF power, then turn ON again. If error is persistent, contact your local distributor or TECO representative.</li> <li>● Check the cable connection between communication interface card SC-C (option) and master controller (PLC).</li> </ul>
<ul style="list-style-type: none"> <li>● Poor connection</li> <li>● Defective communication software (PLC)</li> </ul>	<ul style="list-style-type: none"> <li>● Check the cable connection between communication interface card SC-C (option) and master controller (PLC).</li> <li>● Check the communication software.</li> </ul>
<ul style="list-style-type: none"> <li>● External noise</li> <li>● Excess vibration or shock</li> <li>● Digital operator fault</li> <li>● Control board fault</li> </ul>	<ul style="list-style-type: none"> <li>● Check the digital operator connection.</li> <li>● Turn OFF the power supply once and turn it ON again. If the fault still exists, replace the digital operator or control board.</li> </ul>

---

# 9. GA7200 TERMINAL FUNCTIONS

TYPICAL CONNECTION DIAGRAM [230V class, 10HP (7.5kW) or less]

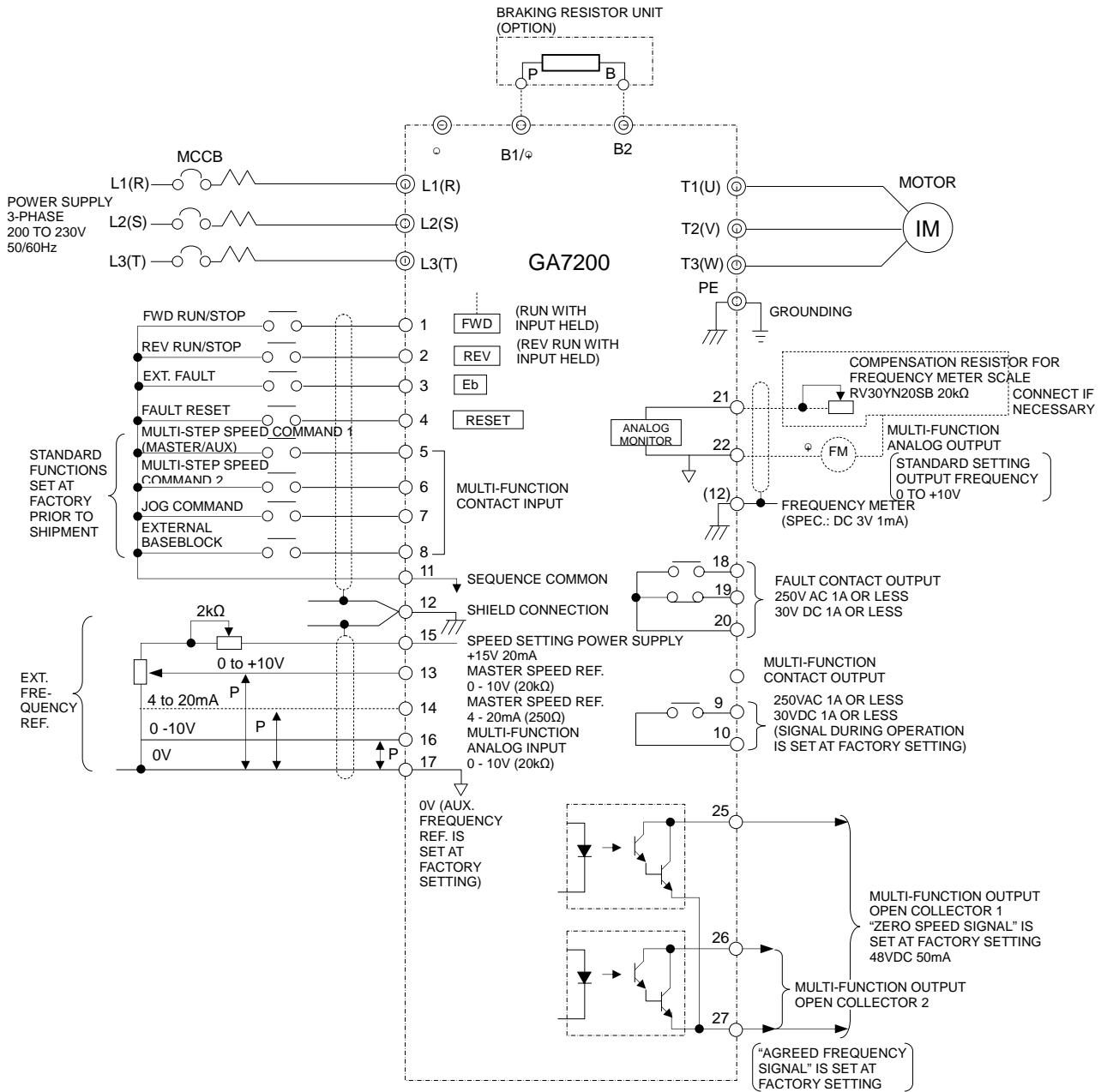

**Notes:**

1. indicates shielded wire and indicates twisted pair shielded wire.
2. Output current capacity of +15 volts in external terminal 15 is max. 20mA.
3. For master speed reference, use control circuit terminal 13 or 14.
4. Terminal Symbols:  $\odot$  indicates main circuit;  $\circ$  indicates control circuit.
5. Multi-function analog output is used for an indicator (e.g. frequency meter). It cannot be used for control system such as feedback control.

# 10. APPENDIX (OPTION PERIPHERAL)

## 10.1 OPTION CARDS

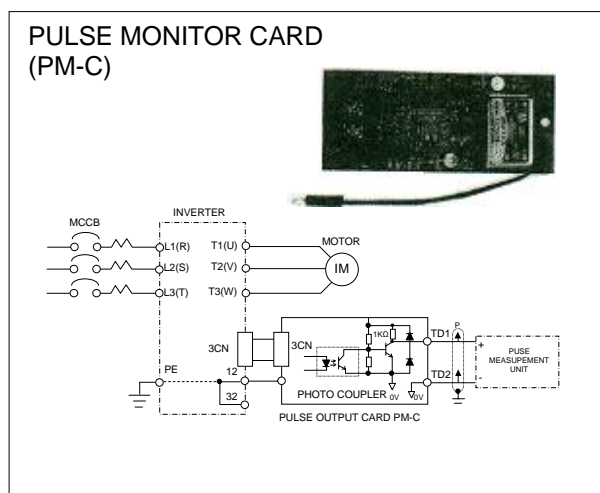
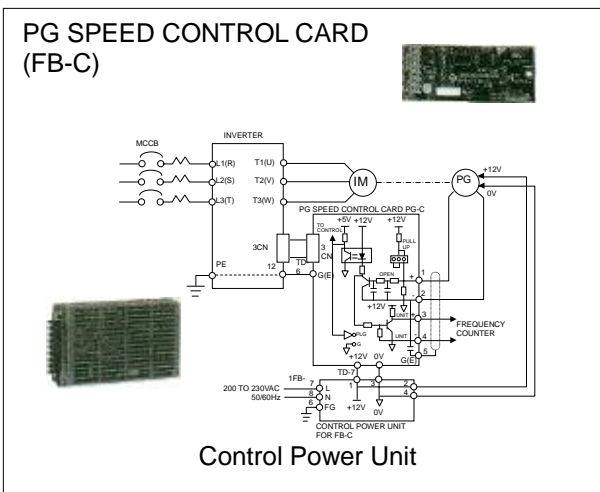
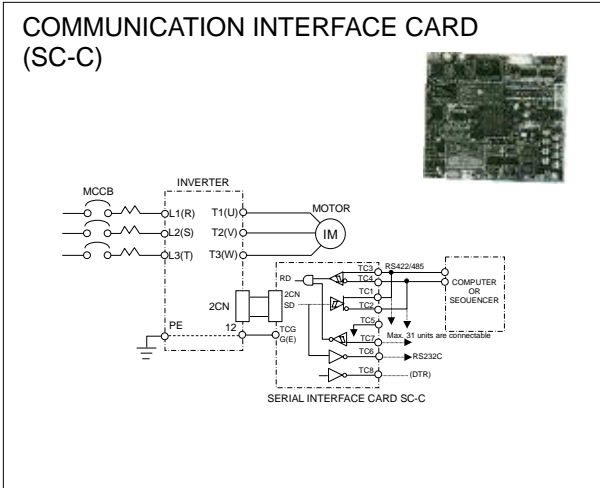



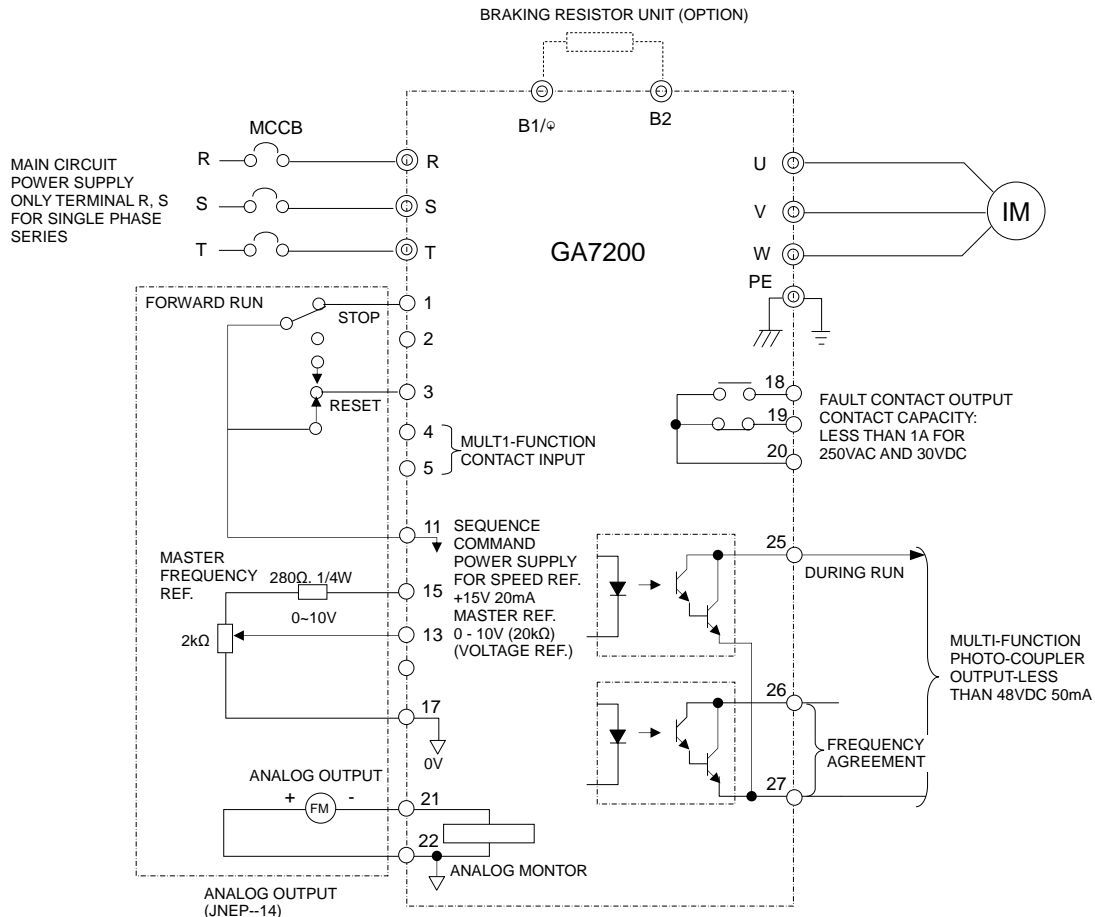

## 10.2 ANALOG OPERATOR

The GA7200 has two types of operator panels: digital operator (JNEP--12) and analog operator (JNEP--14). The optional analog operator is used for simple applications where no complicated constant settings are necessary.



### Notes:

1.  indicates shielded leads and  indicates twisted-pair shielded leads
2. External terminal (10) of +12V has maximum output current capacity of 20mA.
3. Terminal Symbols:  indicates main circuit;  indicates control circuit.
4. Analog operator as shown in figure below,  is used for RESET function.
5. Constant setting  
Sn-04 = x x 00

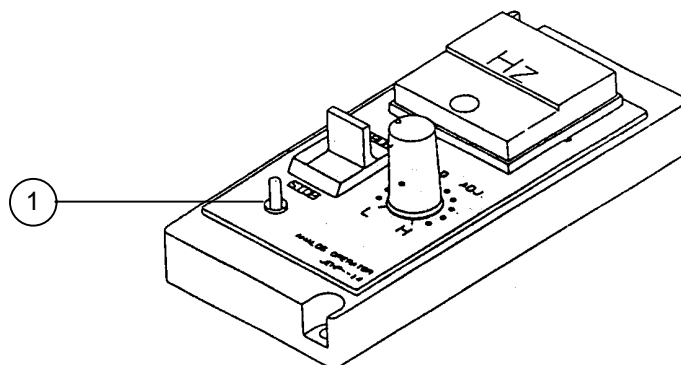

### 10.3 BRAKING RESISTOR AND BRAKING UNIT

- GA7200 230V class 20HP (15kW) or below and 460V class 20HP or below, the braking transistor is built-in as standard, it is only necessary to connect braking resistor to B1/Φ, B2 terminal.
- When connecting braking resistor or braking unit with braking resistor, set system constant Sn-10 = XX10.
- Braking resistor (inverter mounted type or separately mounted type) and braking unit selection table is shown below.

Inverter mounted type braking resistor



Braking unit



Separately mounted type braking resistor



Inverter		Inverter Mounted Type				Separately Mounted Type							
V	HP	Braking Resistor		Braking Torque % (3%ED)	Braking Unit			Braking Resistor		No. of Units		Braking torque % (10%ED)	
		Type (150W)	Code No. 3H333C001□		Number used	Type JUV□□□□---	Code No. 3H333C003□	Number used	Code No. 3H333C002□	Type (1 set)	Number used		Connectable Maximum
230V	1	200Ω	0013	1	125	-	-	-	0019	70W 220Ω	1	4	125
	2	100Ω	0021	1	125	-	-	-	0027	260W 200Ω	1	5	125
	3	70Ω	0030	1	120	-	-	-	0035	260W 70Ω	1	4	120
	5	62Ω	0048	1	100	-	-	-	0043	390W 40Ω	1	2	125
	7.5	-	-	-	-	-	-	-	0051	520W 30Ω	1	3	115
	10	-	-	-	-	-	-	-	0060	780W 20Ω	1	2	125
	15	-	-	-	-	-	-	-	0078	2400W 13.6Ω	1	1	125
	20	-	-	-	-	-	-	-	0086	3000W 10Ω	1	1	125
	25	-	-	-	-	LV-0060	0022	1	0094	4800W 8Ω	1	1	125
	30	-	-	-	-	LV-0060	0022	1	0108	4800W 6.8Ω	1	1	125
	40	-	-	-	-	LV-0040	0014	2	0086	3000W 10Ω	2	1	125
	50	-	-	-	-	LV-0040	0014	2	0086	3000W 10Ω	2	1	100
	60	-	-	-	-	LV-0060	0022	2	0094	4800W 6.8Ω	2	1	120
	75	-	-	-	-	LV-0060	0022	3	0094	4800W 6.8Ω	2	1	100
100	-	-	-	-	LV-0060	0022	3	0094	4800W 6.8Ω	3	1	110	
460V	1	750Ω	0056	1	130	-	-	-	0116	75W 750Ω	1	7	130
	2	400Ω	0064	1	125	-	-	-	0124	260W 400Ω	1	6	125
	3	300Ω	0072	1	115	-	-	-	0132	260W 250Ω	1	3	135
	5	200Ω	0013	1	110	-	-	-	0141	390W 150Ω	1	4	135
	7.5	-	-	-	-	-	-	-	0159	520W 100Ω	1	3	135
	10	-	-	-	-	-	-	-	0167	780W 75Ω	1	2	130
	15	-	-	-	-	-	-	-	0175	1040W 50Ω	1	2	135
	20	-	-	-	-	-	-	-	0175	1040W 50Ω	1	2	100
	25	-	-	-	-	HV-0040	0031	1	0191	4800W 32Ω	1	1	125
	30	-	-	-	-	HV-0040	0031	1	0205	4800W 27.2Ω	1	1	125
	40	-	-	-	-	HV-0040	0049	1	0213	6000W 20Ω	1	1	125
	50	-	-	-	-	HV-0060	0049	1	0221	9600W 16Ω	1	1	125
	60	-	-	-	-	HV-0060	0031	1	0230	9600W 13.6Ω	1	1	125
	75	-	-	-	-	HV-0040	0049	2	0213	600W 20Ω	2	1	135
100	-	-	-	-	HV-0060	0031	2	0230	9600W 13.6Ω	2	1	145	
150	-	-	-	-	HV-0040	0049	3	0213	600W 20Ω	3	1	100	
215	-	-	-	-	HV-0060	0049	4	0230	9600W 13.6Ω	4	1	140	
250	-	-	-	-	HV-0060	0049	4	0230	9600W 13.6Ω	4	1	120	



---

	300	-	-	-	-	HV-0060	0049	5	0230	9600W 13.6Ω	5	1	125
	300	-	-	-	-	HV-0060	0049	6	0230	9600W 13.6Ω	6	1	110

## 10.4 AC REACTOR

- When power capacity is significantly large compared to inverter capacity, or when the power factor needs to be improved, externally connect an AC reactor.
- GA7200 230V/460V 20HP (15kW) or smaller have external DC reactor connecting terminals, external connecting optional DC reactor is possible. GA7200 230V/460V 25HP (18.5kW) or larger have built-in DC reactor.

Voltage	Max. Applicable Motor Output HP	Current Value A	Inductance mH	Code NO. 3M200D161 <input type="checkbox"/>
230V	0.5	2.5	4.2	0013
	1	5	2.1	0021
	2	10	1.1	0030
	3	15	0.71	0048
	5	20	0.53	0056
	7.5	30	0.35	0064
	10	40	0.265	0072
	15	60	0.18	0081
	20	80	0.13	0099
	25	90	0.12	0102
	30	120	0.09	0111
	40	160	0.07	0269
	50	200	0.05	0277
	60	240	0.044	0285
	75	280	0.038	0293
100	360	0.026	0307	
460V	0.5	1.3	18.0	0129
	1	2.5	8.4	0137
	2	5	4.2	0145
	3	7.5	3.6	0153
	5	10	2.2	0161
	7.5	15	1.42	0170
	10	20	1.06	0188
	15	30	0.7	0196
	20	40	0.53	0200
	25	50	0.42	0218
	30	60	0.36	0226
	40	80	0.26	0234
	50	90	0.24	0242
	60	120	0.18	0251
	75	150	0.15	0315
	100	200	0.11	0323
	150	250	0.09	0331
	215	330	0.06	0340
	250	<b>CONSULT FACTORY</b>		
	300			
400				

## 10.5 NOISE FILTER

### A. INPUT NOISE FILTER

There are two types of input noise filters: board type (open chassis) and standard type (enclosed). When EMC filter is installed as indicated, the GA7200 will comply with the EN50081-2 (1994) noise interference suppression directive.

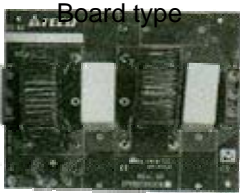

Board type

Max. Applicable Motor Output



Standard type

(Manufactured by TECO)

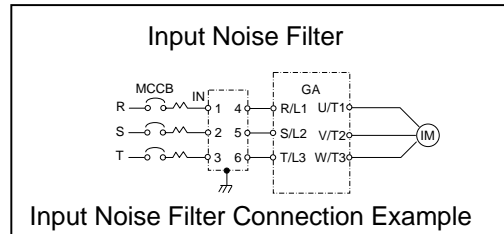

Voltage	HP (KW)	Standard Type (enclosed)			Board Type (chassis)		
		Code JUNG	Q'ty	Rated Current (A)	Code JUNF	Q'ty	Rated Current (A)
230V	0.5 (0.4)	JUNF32006S	1	6A	LAAA 0005	1	5A
	1 (0.75)	JUNF32006S	1	6A	LAAA 0005	1	5A
	2 (1.5)	JUNF32012S	1	12A	LAAA 0012	1	12A
	3 (2.2)	JUNF32012S	1	12A	LAAA 0012	1	12A
	5 (3.7)	JUNF32024S	1	24A	LAAA 0024	1	24A
	7.5 (5.5)	JUNF32024S	1	24A	LAAA 0024	1	24A
	10 (7.5)	JUNF32048S	1	48A	LAAA 0024	2	48A
	15 (11)	JUNF32048S	1	48A			
	20 (15)	JUNF32070S	1	70A			
	25 (18.5)	JUNF32100S	1	100A			
	30 (22)	JUNF32100S	1	100A			
	40 (30)	JUNF32130S	1	130A			
	50 (37)	JUNF32170S	1	170A			
	60 (45)	LABA 0300	1	300A			
	75 (55)	LABA 0300	1	300A			
100 (75)	LABA 0300	1	300A				
460V	0.5 (0.4)	JUNF34006S	1	6A	HAAA 0005	1	5A
	1 (0.75)	JUNF34006S	1	6A	HAAA 0005	1	5A
	2 (1.5)	JUNF34006S	1	6A	HAAA 0005	1	5A
	3 (2.2)	JUNF34006S	1	6A	HAAA 0012	1	12A
	5 (3.7)	JUNF34012S	1	12A	HAAA 0012	1	12A
	7.5 (5.5)	JUNF34012S	1	12A	HAAA 0024	1	24A
	10 (7.5)	JUNF34024S	1	24A	HAAA 0024	1	24A
	15 (11)	JUNF34024S	1	24A			
	20 (15)	JUNF34048S	1	48A			
	25 (18.5)	JUNF34048S	1	48A			
	30 (22)	JUNF34048S	1	48A			
	40 (30)	JUNF34070S	1	70A			
	50 (37)	JUNF34100S	1	100A			
	60 (45)	JUNF34100S	1	100A			
	75 (55)	JUNF34130S	1	130A			
	100 (75)	JUNF34170S	1	170A			
	125 (94)	JUNF34280R	1	280A			
	150 (113)	JUNF34280R	1	280A			
175 (131)	JUNF34400R	1	400A				
215 (161)	JUNF34480R	1	400A				

---

## B. ZERO PHASE NOISE SUPPRESSOR

- CODE NO: JUNFOC046S-----
- Feature

1. high attenuation, as shown in curve below.
2. simple connection.
3. single type suitable for all series inverter, can be used on inverter's input side or output side.

- NOISE Attenuation Characteristics (10 turns)

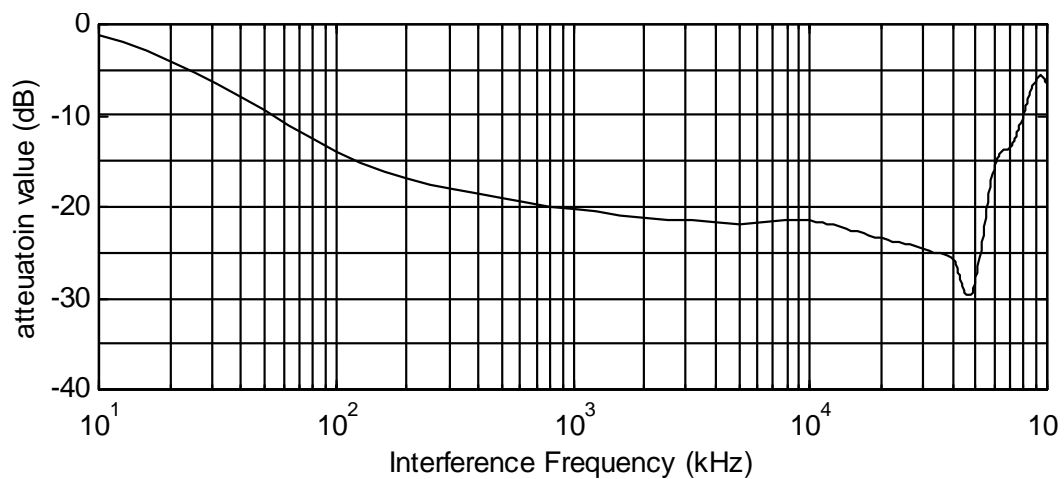

- Application example

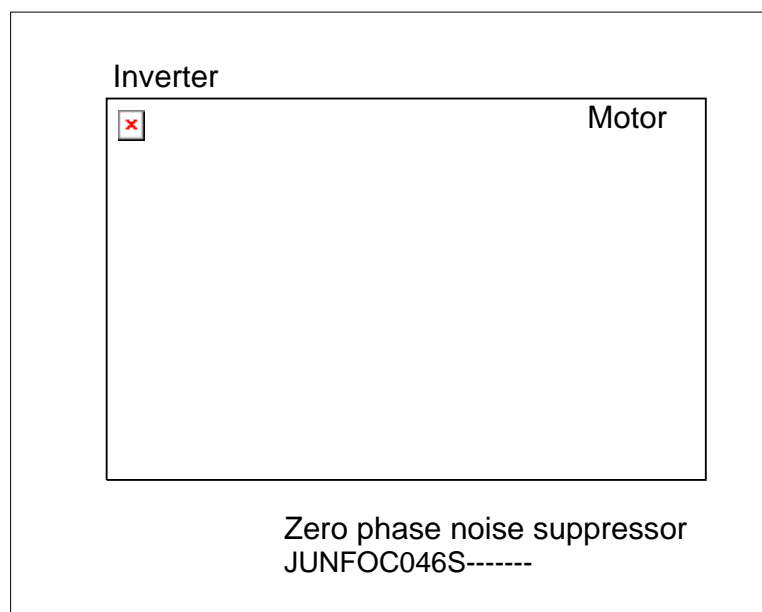

---

DISTRIBUTED BY:

**ACP&D Limited**

Units 6 & 9A,  
Charlestown Industrial Estate,  
Robinson Street,  
Ashton-under-Lyne,  
Lancashire, OL6 8NS.

Tel: +44 (0)161 343 1884  
Fax: +44 (0)161 339 0650  
e-mail: [sales@acpd.co.uk](mailto:sales@acpd.co.uk)  
Websites: [www.acpd.com](http://www.acpd.com) &  
[www.acpd.co.uk](http://www.acpd.co.uk)



2/1/2001