

# **MITSUBISHI**

## **GENERAL-PURPOSE INVERTER**

### **FREQROL-A024**

## **INSTRUCTION MANUAL**

**FR-A024-0.1K ~ 3.7K(P)-(UL)**

**FR-A044-0.4K ~ 3.7K(P)-(UL)**

# SAFETY PRECAUTIONS

## APPLICATION OF THE CAUTION SEALS

These seals indicate warnings for use of the Mitsubishi inverter to ensure safety. When the "retry function" and "automatic restart after instantaneous power failure" has been selected, apply the above labels according to the application spaces.

When the retry function has been selected, apply these CAUTION seals to easily identifiable places.

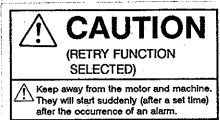

When automatic restart after instantaneous power failure has been selected, apply these CAUTION seals to easily identifiable places.

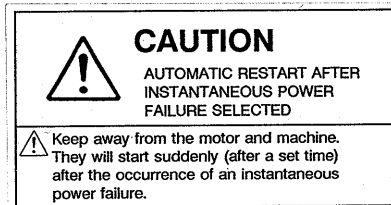
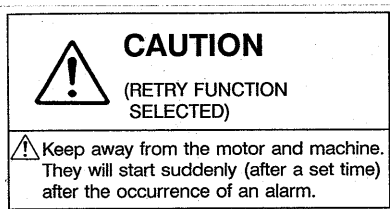

## MONITORING MODE DISPLAY LABELS

These are monitoring mode display labels for the parameter unit. To display the motor speed (rpm), line speed (m/min) or the like, apply the required labels on the left to the unit character portions "Hz", "V" according to the display unit.

rpm rpm

m/min m/min

m<sup>3</sup>/min m<sup>3</sup>/min l/min l/min

% % ×0.1 ×0.1 ×0.01 ×0.01

### PARAMETER UNIT FR-PU03

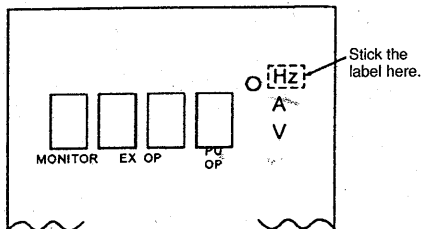

# SETTING MEMO

This seal allows a record of the set values for all functions to be kept so that they can be checked at any time. Stick it to the surface of the inverter, or operation box, etc., as required (do not stick it to the rear face of the inverter cover).

## SETTING MEMO (FR-A024-(UL))

Pr. No.	Name	Setting range	Factory setting	Customer's setting
0	Torque boost (manual)	0 to 30%	6%	
1	Upper limit frequency	0 to 120Hz	120Hz	
2	Lower limit frequency	0 to 120Hz	0Hz	
3	Base frequency	0 to 400Hz	60Hz	
4	3-speed setting (high speed)	0 to 400Hz	60Hz	
5	3-speed setting (middle speed)	0 to 400Hz	30Hz	
6	3-speed setting (low speed)	0 to 400Hz	10Hz	
7	Acceleration time	0 to 3600 sec.	5 sec.	
8	Deceleration time	0 to 3600 sec.	5 sec.	
9	Electronic thermal overload relay	0 to 500A	Rated output current (Note 1)	
10	DC injection braking frequency	0 to 120Hz	3Hz	
11	DC injection braking time	0 to 10 sec.	0.5 sec.	
12	DC injection braking voltage	0 to 30%	6%	
13	Starling frequency	0 to 60Hz	0.5Hz	
14	Selection of applied load	0, 1, 2, 3	0	
15	Log frequency	0 to 400Hz	5Hz	
16	Log accel/decel time	0 to 3600 sec.	0.5 sec.	
17	External thermal relay input	0, 1	0	
18	Upper limit frequency for high speed operation	120 to 400Hz	120Hz	
19	Base frequency voltage	0 to 1000V, 9999	9999	
20	Reference frequency for acceleration/deceleration	1 to 400Hz	60Hz	
22	Stall prevention function operation level	0 to 200%	150%	
23	Stall prevention function operation level offset coefficient for double-speed operation	0 to 200%, 9999	9999	
24	Multiple-speed setting (speed 4)	0 to 400Hz, 9999	9999	
25	Multiple-speed setting (speed 5)	0 to 400Hz, 9999	9999	
26	Multiple-speed setting (speed 6)	0 to 400Hz, 9999	9999	
27	Multiple-speed setting (speed 7)	0 to 400Hz, 9999	9999	
29	Selection of acceleration/deceleration pattern	0, 1, 2	0	
30	Selection of regenerative brake duty ratio	0, 1	0	
31	Computer link E <sup>2</sup> ROM write validity	0, 1, 9999	0	
32	Communication speed	12, 24, 48, 96, 9999	96	
33	Operation command selection	0, 1, 9999	0	
34	Speed command selection	0, 1, 9999	0	
35	Start-up operation mode	0, 1, 9999	0	
36	Stator number selection	0 to 31, 9999	0	
37	Speed display	0, 0.01 to 9998	0	
38	Frequency at 5V (10V) input	1 to 400Hz	60Hz	
39	Frequency at 20mA input	1 to 400Hz	60Hz	
40	Allocation of output terminals	00 to 44	2	
41	Adjusting the SU frequency band width	0 to 100%	10%	
42	FU frequency value	0 to 400Hz	6Hz	
43	FU frequency value in reverse rotation	0 to 400Hz, 9999	9999	
44	2nd acceleration/deceleration time	0 to 3600 sec., 9999	9999	
45	2nd deceleration time	0 to 3600 sec., 9999	9999	
46	2nd torque boost	0 to 30%, 9999	9999	
47	2nd V/F (base frequency)	0 to 400Hz, 9999	9999	
48	Data length	0, 1, 9999	1	
49	Stop bit length	0, 1, 9999	1	
50	Parity check	0, 1, 2, 9999	2	
51	CR, LF code selection	0, 1, 2, 9999	1	
52	Number of communication retries	0 to 10, 9999	1	
53	Communication check time interval	0, 0.1 to 999.8, 9999	0	
54	Selection of FM terminal function	0, 1	0	
55	Reference for frequency monitor (FM)	0 to 400Hz	60Hz	
56	Reference for current monitor (FM)	0 to 500A	Rated output current	

Pr. No.	Name	Setting range	Factory setting	Customer's setting
57	Free-wheeling time for restart	0, 0.1 to 5 sec., 9999	9999	
58	Start-up time for restart	0 to 5 sec.	0.5 sec.	
59	Input terminal allocation	0 to 9998, 9999	9999	
60	Input filter time constant	1 to 8, 9999	9999	
61	Tone control selection	0, 1	0	
62	Open motor circuit detection level	0 to 200%, 9999	5.0%	
63	Open motor circuit detection time	0.05 to 1.0 sec., 9999	0.5 sec.	
64	Constant output range slip compensation selection	0, 9999	9999	
65	Relay selection	0, 1, 2, 3	0	
66	Frequency for stall prevention function level reduction start frequency	0 to 400Hz	60Hz	
67	Retry count after an occurrence of inverter alarm	0 to 10, 101 to 110	0	
68	Retry waiting time	0.1 to 360 sec.	1 sec.	
69	Clearing retry count	0, 1	0	
70	Special regenerative brake duty ratio	0 to 30% (Note 2)	0%	
71	Applicable motor selection	0, 1	0	
72	Selection for PWM frequency	0.7 to 14.5kHz	1kHz	
73	Selection for 0 to 5V/0 to 10V	0, 1, 5	0	
74	Selection for current input reference/starting command, rotation direction command selection	0, 1, 100, 101	0	
75	Reset selection/detection of parameter unit disconnection	0 to 3, 14 to 17	14	
76	Slip compensation time constant	0.01 to 10 sec., 9999	0.5 sec.	
77	Selection for disabling parameter wiring	0, 1, 2	0	
78	Selection for reverse rotation prevention	0, 1, 2	0	
79	Selection of operation mode	0 to 4, 6 to 8	0	
80	Motor capacity	0.1 to 3.7kW, 9999 (Note 3)	9999	
81	Rated slip	0 to 10%, 9999	9999	
91	Frequency jump 1A	0 to 400Hz, 9999	9999	
92	Frequency jump 1B	0 to 400Hz, 9999	9999	
93	Frequency jump 2A	0 to 400Hz, 9999	9999	
94	Frequency jump 2B	0 to 400Hz, 9999	9999	
95	Frequency jump 3A	0 to 400Hz, 9999	9999	
96	Frequency jump 3B	0 to 400Hz, 9999	9999	
126	Multi-speed (speed 8)	0 to 400Hz, 9999	9999	
127	Multi-speed (speed 9)	0 to 400Hz, 9999	9999	
128	Multi-speed (speed 10)	0 to 400Hz, 9999	9999	
129	Multi-speed (speed 11)	0 to 400Hz, 9999	9999	
130	Multi-speed (speed 12)	0 to 400Hz, 9999	9999	
131	Multi-speed (speed 13)	0 to 400Hz, 9999	9999	
132	Multi-speed (speed 14)	0 to 400Hz, 9999	9999	
133	Multi-speed (speed 15)	0 to 400Hz, 9999	9999	
900	FM terminal calibration	—	—	
902	Bias for frequency setting	0 to 10V	0 to 60Hz	(0V) 0Hz
903	Gain for frequency setting voltage	0 to 10V	1 to 400Hz	(5V) 60Hz
904	Bias for frequency setting current	0 to 20mA	0 to 60Hz	(4mA) 0Hz
905	Gain for frequency setting current	0 to 20mA	1 to 400Hz	20mA 0Hz
990	Selection for key click sound	0, 1	0	
991	Selection of the parameter unit display data	0, 1, 2	0	
996	Alarm clear	—	—	
997	Inverter reset	—	—	
998	Parameter all clear	—	—	
999	Parameter clear	—	—	

Notes: 1. Inverter rated output current value (A)  
 0.1K ..... 0.7A    0.2K ..... 1.3A    0.4K ..... 2.6A    0.75K ..... 4.3A  
 2. The duty ratio indicates the "KED" of the operation of the built-in brake transistor. Pr. 70 can't be read when Pr.30 is equal to 0.  
 3. 200V class: 0.1 to 3.7kW    400V class: 0.2 to 3.7kW

Thank you for choosing the Mitsubishi Inverter.

This instruction manual gives handling information and precautions for use of this equipment. Incorrect handling might cause an unexpected fault. Before using the inverter, please read this manual carefully to use the equipment to its optimum. Please forward this manual to the end user.

### **This section is specifically about safety matters**

Do not attempt to install, operate, maintain or inspect the inverter until you have read through this instruction manual and appended documents carefully and can use the equipment correctly. Do not use the inverter until you have a full knowledge of the equipment, safety information and instructions.

In this instruction manual, the safety instruction levels are classified into "WARNING" and "CAUTION".



Assumes that incorrect handling may cause hazardous conditions, resulting in death or severe injury.











Assumes that incorrect handling may cause hazardous conditions, resulting in medium or slight injury, or may cause physical damage only.

Note that the CAUTION level may lead to a serious consequence according to conditions. Please follow the instructions of both levels because they are important to personnel safety.

## SAFETY INSTRUCTIONS





### 1. Electric Shock Prevention

#### **WARNING**

-  While power is on or when the inverter is running, do not open the front cover. You may get an electric shock.
-  Do not run the inverter with the front cover removed. Otherwise, you may access the exposed high-voltage terminals and charging part and get an electric shock.
-  If power is off, do not remove the front cover except for wiring or periodic inspection. You may access the charged inverter circuits and get an electric shock.
-  Before starting wiring or inspection, switch power off, wait for more than 10 minutes, and check for no residual voltage with a tester.
-  Use a class 3 or higher earthing method to earth the inverter.
-  Any person who is involved in the wiring or inspection of this equipment should be fully competent to do the work.
-  Always install the inverter before wiring. Otherwise, you may get an electric shock or be injured.
-  Operate the switches with dry hands to prevent an electric shock.
-  Do not subject the cables to scratches, excessive stress, heavy loads or pinching. Otherwise, you may get an electric shock.





### 2. Fire Prevention

#### **CAUTION**

-  Mount the inverter and brake resistor on a non-combustible surface. Installing the inverter directly on or near a combustible surface could lead to a fire.
-  If the inverter has become faulty, switch power off on the inverter's power supply side. A continuous flow of a large current could cause a fire.
-  When using a brake resistor, use a circuit to cut off the power when an inverter error signal occurs. Failure to do so could cause the brake resistor to abnormally overheat and a fire to start if a fault occurs in the brake transistor, etc.
-  Do not connect the resistor directly to the DC terminals P,N. This could cause a fire.

### 3. Injury Prevention

#### **CAUTION**

-  Apply only the voltage specified in the instruction manual to each terminal to prevent damage, etc.
-  Ensure that the cables are connected to the correct terminals. Otherwise, damage, etc. may occur.
-  Always make sure that polarity is correct to prevent damage, etc.
-  While power is on or for some time after power-off, do not touch the inverter or brake resistor as these will be hot and you may be burned.

#### 4. Additional instructions

To prevent injury, damage, or product failure please note the following points.

##### (1) Transportation and mounting

### ⚠ CAUTION

- ⚠ Take care when carrying products, use correct lifting gear.
- ⚠ Do not stack the inverter boxes higher than the number recommended.
- ⚠ Ensure that installation position and material can withstand the weight of the inverter. Install according to the information in the Instruction Manual.
- ⚠ Do not operate if the inverter is damaged or has parts missing.
- ⚠ Do not lift the inverter with the front cover attached. It may fall off.
- ⚠ Do not stand or rest heavy objects on the inverter.
- ⚠ Check the inverter mounting orientation is correct.
- ⚠ Prevent any dust, wire fragments or other foreign bodies from dropping into the inverter during wiring up and commissioning.
- ⚠ Do not drop the inverter, or subject it to impacts.
- ⚠ Use the inverter under the following environmental conditions:

Environment	Conditions
Ambient temperature	-10°C (14°F) to + 50°C (122°F) (non-freezing) (-10°C (14°F) to + 40°C (104°F) when the dust-protection structure attachment is used)
Ambient humidity	90%RH or less (non-condensing)
Storage temperature	-20°C (-4°F) to + 65°C (149°F)
Ambience	Indoors, free from corrosive gas, flammable gas, oil mist, dust and dirt.
Altitude, vibration	Max. 1000m (3280.9 feet) above sea level, 5.9m/S <sup>2</sup> (0.6G) or less (conforming to JIS C 0911)

- Temperatures applicable for a short time, e.g. in transit.

##### (2) Wiring

### ⚠ CAUTION

- ⚠ Do not fit capacitive equipment such as power factor correction capacitor, noise filter or surge suppressor onto the output of the inverter.
- ⚠ The connection orientation of the output cables U, V, W to the motor will affect the direction of rotation of the motor.

##### (3) Trial run

### ⚠ CAUTION

- ⚠ Check all parameters, and ensure that the machine will not be damaged by sudden start-up.

#### (4) Operation

### ⚠ CAUTION

- ⚠ When retry function is selected, the inverter will try to restart the machine up to 10 times over a one hour period. Ensure operator safety with other devices.
- ⚠ The stop key is valid only when function setting has been made. Prepare an emergency stop switch separately.
- ⚠ Switch off the start signal when resetting the inverter. Failure to do so may start the motor immediately after reset.
- ⚠ Do not use for loads other than the 3-phase induction motor. If another electric device is connected to the inverter output, the device could be damaged.
- ⚠ Do not modify the equipment.
- ⚠ The electronic motor thermal protection does not guarantee to prevent motor burn out.
- ⚠ Do not use a contactor on the inverter input for frequent starting/stopping of the inverter, use control signals.
- ⚠ To reduce the effect of mains conducted electromagnetic interference, use a RFI noise filter. Take care to ensure that electromagnetic radiation from the inverter does not damage or affect the operation of nearby electrical equipment.
- ⚠ When driving a 400 V class motor with the inverter, use an insulation-enhanced motor, or measures should be taken to suppress the surge voltage. Surge voltages attributable to the wiring constant may occur at motor terminals, deteriorating the insulation of the motor.
- ⚠ When parameter clear or all parameter clear is performed, each parameter returns to the factory setting. Re-set the required parameters before starting operation.
- ⚠ The inverter can be easily set for high-speed operation. Before changing its setting, fully examine the performances of the motor and machine.
- ⚠ The inverter does not have a holding stop facility. For emergency stop, another circuit must be used.

#### (5) Emergency stop

### ⚠ CAUTION

- ⚠ Provide a safety backup such as an emergency brake which will prevent the machine and equipment from hazardous conditions if the inverter fails.

#### (6) Maintenance, inspection and parts replacement

### ⚠ CAUTION

- ⚠ Do not carry out a megger (insulation resistance) test on the control circuit of the inverter.

#### (7) Disposing of the inverter.

### ⚠ CAUTION

- ⚠ Treat as industrial waste.

#### (8) General

Many of the diagrams and drawings in the instruction manual show the inverter without a cover, or partially open. Never run the inverter like this. Always replace the cover and follow this instruction manual when operating the inverter.

# CONTENTS

---

## GUIDELINES FOR HANDLING

1. PRECAUTIONS .....	1
2. NOMENCLATURE AND FUNCTIONS .....	2
3. PREPARATION BEFORE OPERATION .....	8
4. OPERATION CONTROL MODES .....	9
5. INSTALLATION .....	10
6. WIRING .....	11
6.1 Precautions .....	11
6.2 Connecting the Power Supply and Motor .....	14
6.3 Connecting the Control Signals .....	15
6.4 Operating the Inverter Using Single-Phase Power Supply .....	16
6.5 Wiring Procedures .....	17
7. SETTING PARAMETERS BEFORE STARTUP .....	19
8. NOMENCLATURE OF PARAMETER UNIT .....	21
9. PRECAUTIONS ON OPERATING THE PARAMETER UNIT .....	22
10. OUTLINE OF THE FUNCTIONS .....	24
11. OPERATION .....	25
11.1 Operation Modes .....	25
11.2 Selecting the Operation Mode .....	26
11.3 External Operation Mode (Operation Using External input Signals) .....	28
11.4 PU Operation Mode (Operation Using the Parameter Unit) .....	29
11.5 Combination Operation Mode (Operation Using both External Signals and Parameter Unit) .....	31
11.6 Switch over mode .....	34
11.7 Edit Enable Signal Mode .....	35
11.8 Local/Auto External Signal Selection Mode .....	37
12. SETTING AND CHANGING THE PARAMETERS .....	38
13. INITIALIZING THE PARAMETERS .....	39
13.1 Parameter Clear .....	39
13.2 Parameter All Clear .....	40
14. MONITORING .....	41
15. ERRORS .....	42
15.1 Error Codes and Contents of Errors .....	42
15.2 Digital Display (7-Segment Display) and Actual Characters .....	43
15.3 Logged Error Contents .....	44
15.4 Clearing Error Log .....	45



<b>16. PARAMETER UNIT DISCONNECTION DETECTION FUNCTION</b> .....	46
<b>17. RESETTING THE INVERTER</b> .....	48
<b>18. CALIBRATING THE FREQUENCY METER</b> .....	49
<b>19. ADJUSTING "BIAS" AND "GAIN" OF FREQUENCY SETTING SIGNALS</b> .....	50
<b>20. CONTROLLING KEY CLICK SOUND (TACTILE FEED BACK)</b> .....	52
<b>21. SELECTING GENERAL-PURPOSE MAGNETIC FLUX VECTOR CONTROL</b> .....	53
<b>22. PARAMETERS</b> .....	57
• Parameter List .....	57
• Description of the Parameters .....	62
[Pr.0] Setting the torque boost (manual) .....	62
[Pr.1] [Pr.2] Setting the upper/lower limit of frequency .....	62
[Pr.3] Setting the base frequency .....	63
[Pr.4] [Pr.5] [Pr.6] Setting the multiple-speed .....	64
[Pr.7] [Pr.8] Setting the acceleration/deceleration time .....	65
[Pr.9] Setting the electronic thermal relay .....	65
[Pr.10] [Pr.11] [Pr.12] Adjusting the DC dynamic braking .....	66
[Pr.13] Setting the starting frequency .....	66
[Pr.14] Selecting the applied load .....	67
[Pr.15] [Pr.16] Setting the jog operation .....	67
[Pr.17] Setting the thermal relay input .....	68
[Pr.18] Setting the upper limit frequency for high speed operation .....	68
[Pr.22] [Pr.23] [Pr.66] Setting the stall prevention function operation level .....	69
[Pr.29] Selecting the acceleration/deceleration pattern .....	70
[Pr.30] [Pr.70] Setting the regenerative brake duty ratio .....	71
[Pr.31] [Pr.32] [Pr.33] [Pr.34] [Pr.35] [Pr.36] Serial communication functions .....	72
[Pr.37] Setting the speed display unit .....	73
[Pr.38] Frequency at 5V (10V) input .....	73
[Pr.39] Frequency at 20mA input .....	73
[Pr.40] Setting the allocation of output terminals .....	74
[Pr.41] Adjusting the SU frequency bandwidth .....	74
[Pr.42] [Pr.43] Setting the sensing for output frequency .....	75
[Pr.44] [Pr.45] [Pr.46] [Pr.47] Setting the second control functions .....	76
[Pr.54] Selecting the FM terminal function .....	76

<b>Pr.55</b>	Reference for frequency monitor	77
<b>Pr.56</b>	Reference for current monitor	77
<b>Pr.57</b>	<b>Pr.58</b> Operation restart after instantaneous power failure	77
<b>Pr.59</b>	Input terminal allocation	78
<b>Pr.60</b>	Input filter time constant	80
<b>Pr.61</b>	Tone control selection	80
<b>Pr.62</b>	<b>Pr.63</b> Open motor circuit detection function	80
<b>Pr.64</b>	<b>Pr.76</b> <b>Pr.81</b> Slip compensation	81
<b>Pr.65</b>	Selection of retry	82
<b>Pr.67</b>	<b>Pr.68</b> <b>Pr.69</b> Retry function	82
<b>Pr.70</b>	Refer to Pr.30.	83
<b>Pr.71</b>	Selecting the applicable motor	83
<b>Pr.72</b>	Changing the PWM carrier frequency	83
<b>Pr.73</b>	Selecting the frequency command voltage range	84
<b>Pr.74</b>	Selecting the current input signal/Starting command • rotation direction command selection	84
<b>Pr.75</b>	Reset selection/detection of parameter unit disconnection	84
<b>Pr.77</b>	Disabling parameter write	86
<b>Pr.78</b>	Reverse lockout	86
<b>Pr.79</b>	Selecting the operation mode	86
<b>Pr.80</b>	Capacity of applicable motor (for general-purpose magnetic flux vector control)	89
<b>Pr.91</b>	<b>Pr.92</b> <b>Pr.93</b> <b>Pr.94</b> <b>Pr.95</b> <b>Pr.96</b> Frequency jump	90
<b>Pr.900</b>	Calibrating the output at terminal FM	91
<b>Pr.902</b>	<b>Pr.903</b> <b>Pr.904</b> <b>Pr.905</b> Adjusting the gain and bias for the frequency setting signal	92
<b>Pr.990</b>	Selecting key click sound (parameter unit)	93
<b>Pr.991</b>	Selection of the parameter unit display data	93
<b>Pr.996</b>	Clearing the alarm	93
<b>Pr.997</b>	Resetting the inverter	93
<b>Pr.998</b>	<b>Pr.999</b> Initializing the parameters	94

<b>23. INSPECTION AND MAINTENANCE</b>	95
23.1 Precautions on Inspection and Maintenance	95
23.2 Inspection Items	95
23.3 Replacing Parts	99
23.4 Measuring Voltage, Current, and Power in Main Circuit	100

<b>24. TROUBLESHOOTING</b>	103
24.1 Inspection by the Display on the Parameter Unit	103
24.2 Problems and Check Point	105
24.3 Protection Functions	107
24.4 Noise	110
24.5 Power Harmonic Guidelines (Japan)	114
<b>25. SPECIFICATIONS</b>	117
25.1 Standard Specifications	117
25.2 Common Specifications	119
25.3 Block Diagram	122
25.4 Definition of Terminals	123
25.5 External Dimensions	125
<b>26. SELECTION OF PERIPHERAL DEVICE</b>	128
<b>27. OPTION</b>	131
<b>APPENDICES</b>	
Appendix 1. INSTRUCTIONS FOR COMPLIANCE WITH THE EUROPEAN DIRECTIVES	APP-1
Appendix 2. INSTRUCTIONS FOR COMPLIANCE WITH THE UL STANDARD	APP-2
Appendix 3. WARRANTY	APP-3

# GUIDELINES FOR HANDLING

Improper handling of an inverter may cause malfunctioning, reduction in service life, or severe damage.

Handle the inverter carefully; refer to the description and caution information provided in this manual.

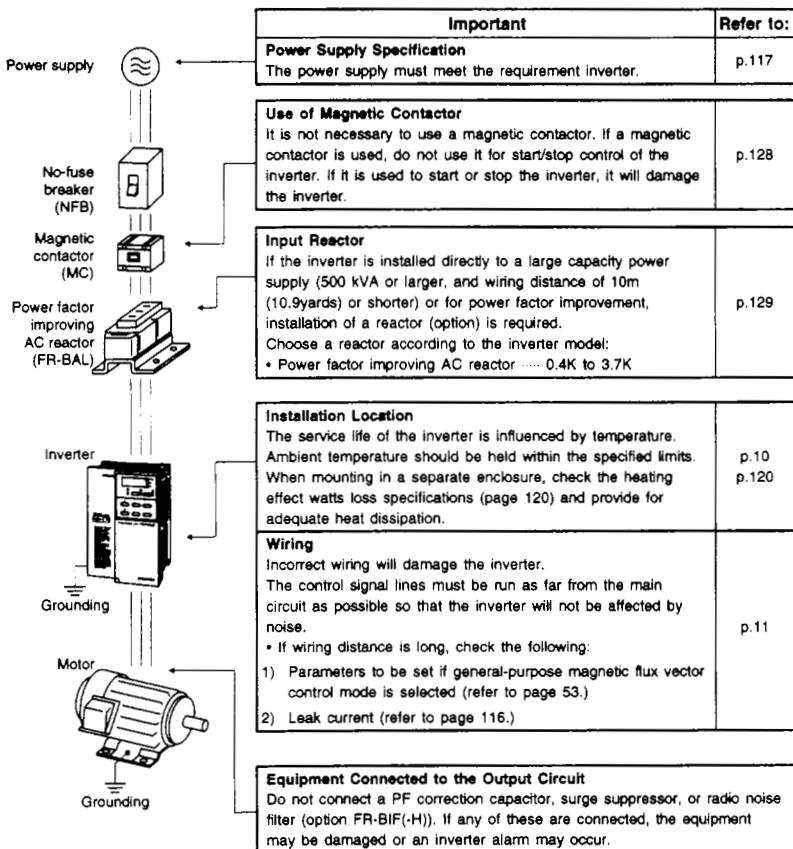

# 1. PRECAUTIONS

## Use the inverter within the permissible ambient temperature range

Temperature has a critical influence on the service life of the inverter. Ambient temperature must be controlled so that the inverter is operated within the permissible temperature range. Also see inverter installation instructions and environment.  
(Refer to page 10.)



## Connecting input power to the output terminals of the inverter, will damage the output transistors.

If power supply voltage is applied to terminals U, V, and W, the inverter will be damaged. Check the wiring and operation sequence (commercial power supply switching, for example) carefully.

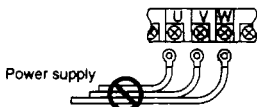

## Do not touch the inside of the inverter during operation

The inverter has high voltage circuits. Before attempting inspection inside the inverter, disconnect power supply and be that the POWER indicating lamp is OFF. (also used as the charge indicating lamp)

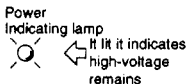

**Note:** It takes more than 60 sec for discharge of the internal capacitor after disconnecting power supply.

## Radio Noises

The inverter input/output circuits (main circuits) contain high harmonics which may cause interference to communication equipment (AM radio) being used near the inverter. If interference occurs, use a noise filter (FR-BIF(-H) option, only for input circuit), or line noise filter (FR-BSF01 option) to reduce radio noise. (For details, refer to page 110 to 116).

## Do not attempt Megger test on inverter control circuit

If insulation resistance is to be measured for the power supply lines and the motor, either disconnect the wire at the inverter terminals or short the terminals as shown in the illustration below.

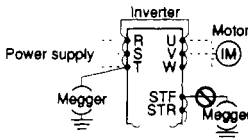

## Do not use disconnect switch magnetic contactor at the inverter output to start or stop the motor (Inverter).

If start/stop of the motor (inverter) is repeated frequently, it will cause failure of the inverter. Use the start signal at the inverter.

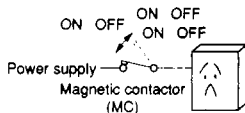

## Do not connect PF correction capacitor, surge suppressor, or radio noise filter (option, FR-BIF) at the output side.

If any of these equipments is connected to the output side of the inverter, it will damage the inverter or damage the capacitor or surge suppressor.

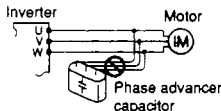

## Grounding

Due to high-speed switching operation of the inverter, leakage current will be increased compared to conventional inverters. Always ground the inverter and the motor. When grounding the inverter, use the grounding terminal provided. Establish a low resistance earth ground as close to the drive as possible. Do not connect through pipe threads, slip joints, or other high resistance paths to ground.

## 2. NOMENCLATURE AND FUNCTIONS

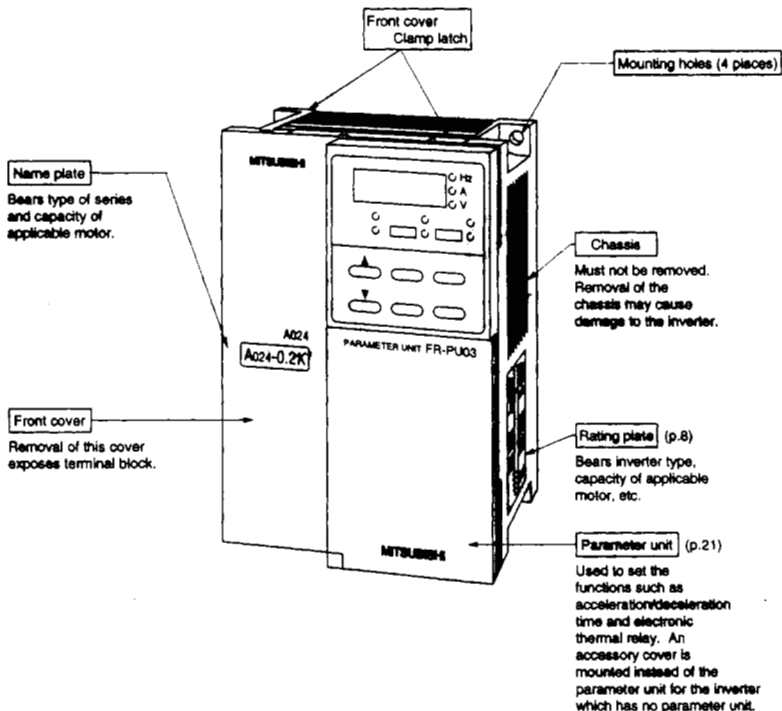

### Description of inverter

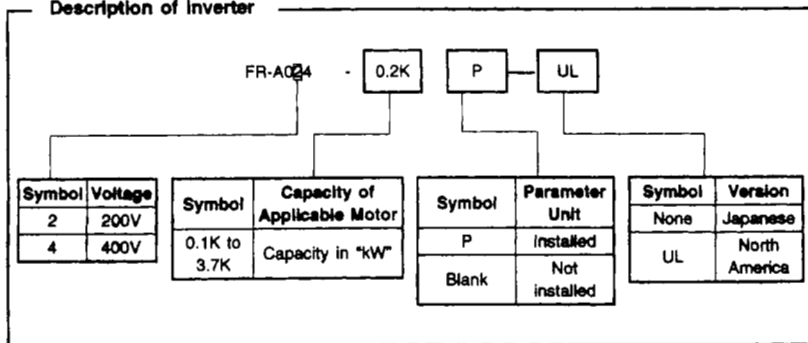

## 2. NOMENCLATURE AND FUNCTIONS

### ■ Inverter without Front Cover

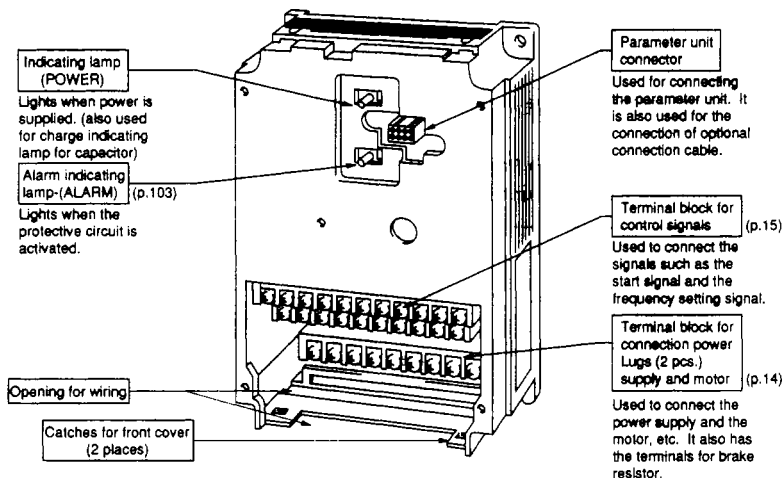

### ■ Removing/Attaching the Front Cover

#### ● Removing the front cover

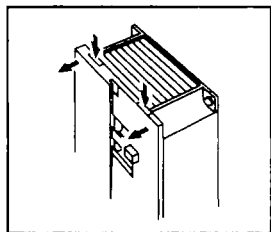

Press down on the latches (2 pcs.) at the top of the front cover and pull forward.

#### ● Attaching the front cover

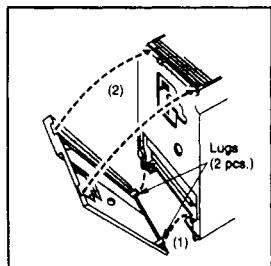

Insert the tabs (2 pcs.) at the bottom of the front cover into the recesses in the chassis and push the front cover toward the chassis until the latches engage securely.

- Notes:**
1. After attaching the front cover, test to make sure that it is securely held in place by the latches.
  2. On inverters equipped with a parameter unit, the inverter cover can not be removed easily because the parameter unit is connected through to the chassis. Therefore, when removing the front cover, use caution not to damage the connector.

## 2. NOMENCLATURE AND FUNCTIONS

### ■ Parameter Unit Location

The parameter unit can be mounted directly on the inverter, or installed in a remote location with an optional cable.

In a remote installation, the parameter unit may be used as a hand-held unit or mounted in an enclosure.

Removal and installation of the parameter unit is permissible while the inverter is powered up or in operation.

### ■ Removing and installing the Parameter Unit

#### ● Removing the parameter unit from the inverter

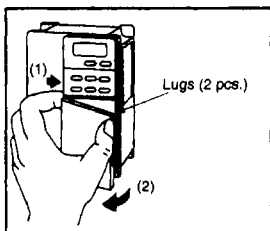

The parameter unit is fixed to the inverter with clamp screws. Follow the steps indicated below to remove it from the inverter.

- (1) Open the cover at the front of the parameter unit.  
(While pressing to the right against the hinge (1) at the upper left of the cover, pull the cover with the thumb lightly pressing on the lug (2), at the upper right of the cover.)

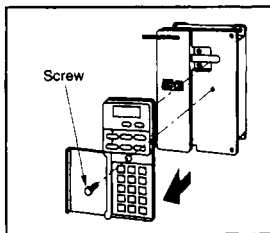

- (2) Remove the clamp screw from the parameter unit. Then, remove the parameter unit from the inverter.

#### ● Installing the parameter unit on the inverter directly

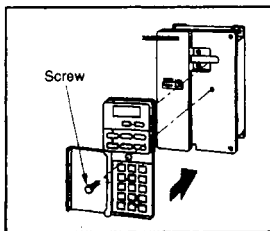

- (1) Connection  
Insert the parameter unit connector into the connector in the inverter as shown in the illustration in the left.  
(Press on the parameter unit to insert the connector securely.)
- (2) Clamping the parameter unit  
Clamp the parameter unit to the inverter with the clamp screw.

**Note:** When installing the parameter unit to the inverter directly, it must be mounted on the front cover of the inverter. Never install it on the inverter with the front cover removed.



## 2. NOMENCLATURE AND FUNCTIONS

### ● Installing the parameter unit using a cable

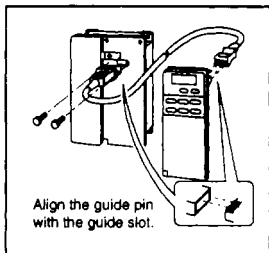

#### (1) Connection

Assemble one end of the connector to the inverter and other end to the parameter unit. Use the guide pin and guide slot to determine the correct connector orientation.

(Forcing the connectors together in opposition to the polarizing guides will damage the inverter.)

#### (2) Fixing

After connecting the connector to the inverter unit, securely fix it with the mounting screws.

**Note:** Use the connection cable available as an optional accessory to the parameter unit.  
If it is necessary to securely fix the cable to the parameter unit, use the L-pattern cable.

### ■ Removing and Attaching the Parameter Unit Cover

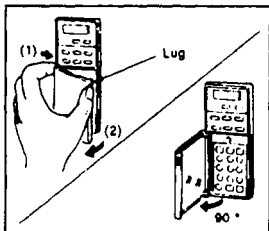

#### (1) Open the parameter unit cover 90°

(While pressing to the right against the hinge (1) at the upper left of the cover, pull the cover with the thumb lightly pressing on the lug (2), at the upper right of the cover.)

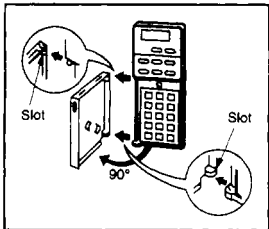

#### (2) Pull the parameter unit cover to the left to remove it from the parameter unit.

(Adjust the parameter unit cover position so that the slot faces in the direction as illustrated in the left. The parameter unit cover can be removed only when the slots are set in this position.)

**Note:** When attaching the parameter unit cover, set the slots in the cover in the direction as illustrated and push to the right.

## 2. NOMENCLATURE AND FUNCTIONS

### ■ Removing and Attaching the Accessory Cover

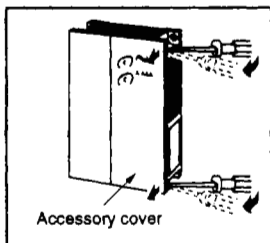

Insert the tip of a screw driver into the slot at the right side of the inverter and pull the handle of the screw driver up around the slot to loosen cover.

Pull the cover toward you to remove.

To attach the accessory cover, insert the left edge of the cover into the slot in the inverter and push the right side of the cover against the inverter.

- Notes:**
1. After attaching the accessory cover to the inverter, test to be sure that it is securely attached.
  2. Do not pry with the screw driver while it is inserted in the slot. Prying may damage or break the accessory cover.

### ■ Handling the FR-ARW03 Parameter Copy Unit

The FR-ARW03 parameter copy unit can be connected to the inverter directly or with an optional cable. Options, function settings, and operation status monitoring can be done, the same as with the FR-PU03. Note that the function assigned to the  key on the FR-ARW03 differs from that on the FR-PU03.

With the FR-ARW03 it is possible to read the inverter parameters set for individual applications collectively and to copy them to other inverters.

- Note:**
1. Do not copy the parameters between differing voltage classes or differing capacities. If the parameters are copied between differing voltage classes or differing capacities, the motor rotation may become unstable, unexpected alarms may occur, or the inverter's performance may be affected. Contact Mitsubishi if the parameters are copied by mistake.
  2. If copying the parameters from old version to new version, the set value of Pr.31 and Pr.81 changes. After parameter copy from old version to new version, manually set "0" to Pr.31 and set "9999" to Pr.81 in new version.

Please see the following serial number to distinguish new version. The serial number is shown on the name plate. New version has the same or higher number.

Model name	Serial Number
FR-A024-0.1K to 1.5K	B63 ○○○○○○
	Y63 ○○○○○○
FR-A024-2.2K, 3.7K	P63 ○○○○○○
FR-A044-0.4K, 0.75K	H63 ○○○○○○
FR-A044-1.5K to 3.7K	J63 ○○○○○○

## 2. NOMENCLATURE AND FUNCTIONS

---

### ■ Handling the FR-PU02.1 Parameter Unit

The FR-PU02.1 parameter unit can be connected to the inverter using an optional cable.

**Note:** With the FR-PU02.1, setting the inverter parameters, operating frequency, and running operation for forward and reverse rotation can be done. However, monitoring (including graphic) and other operations can be done only within a limited range.

If the FR-PU02.1 is used and Pr. 37 (speed unit) is set to 100 or higher, a value that ignores the third and above digits, and which also ignores the monitor display will be applied. (Note that the set value is registered, so if the Pr. 37 set value is read with the FR-PU03, a value that is set to 100 or higher will display.)

### 3. PREPARATION BEFORE OPERATION

#### 1. Unpacking and Checking the Product

After unpacking the inverter, check the rating plate on the right side of the inverter to make sure that you have received the product that you ordered. Also make sure that the product is not damaged.

● Rating plate

MITSUBISHI		INVERTER	
Model	MODEL	FR-A024-0.2K	
	POWER	0.2kW	← Applicable motor capacity
Input rating	AC INPUT	200 to 230V 50/60Hz	
	OUTPUT	1.5A	← Output rating
Serial number	SERIAL	A3X040001	
MITSUBISHI ELECTRIC CORPORATION MADE IN JAPAN			

● Accessory ..... Instruction manual

If any questions arise or delivered product has defects, please contact your Mitsubishi dealer.



#### 2. Preparation of Apparatus and Components Necessary for Operation

The apparatus and components to be used differ depending on the application requirements. Select the necessary items by referring to the table on page 9 (Operation Control Modes).



#### 3. Installation

Install the inverter considering location, physical orientation ambient temperature, and atmospheric conditions. Improper installation may shorten the service life or degrade the performance of the inverter. (see environmental conditions; page 120)



#### 4. Wiring

Connect the input power, output to the motor, and control signal lines to the terminal block. (see cautions on wiring notes; page 11)

## 4. OPERATION CONTROL MODES

The FR-A024 inverter has three operation modes. Select the mode that fits the application and operation conditions, and prepare the components required.

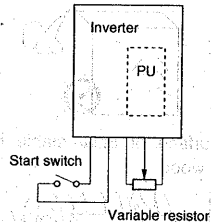
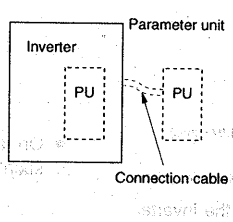
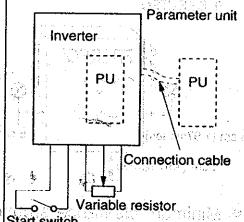
Mode	1. External Signal Operation Mode	2. Parameter Unit (PU) Operation Mode*	3. External Signal/PU Operation Mode
Operation method	Inverter operation is controlled by external operator control devices.	Inverter operation is controlled by using the keys on the parameter unit. (In this operation mode, since no connection of the signal lines is required, the operation can be started immediately after installation.)	In this mode, the inverter is operated using the external control and the keys on the parameter unit, both outlined to the left. (For details, refer to page 31.)
Items to be prepared	<ul style="list-style-type: none"> <li>Start signal Switch, relay, etc.</li> <li>Frequency setting signal can be a variable resistor, or external signals which input one of the following: 0 to 5 VDC, 0 to 10 VDC, 4 to 20mA</li> </ul> <p>Notes:</p> <ol style="list-style-type: none"> <li>The start signal itself is not sufficient for operating the inverter. It is necessary to send a frequency setting signal with the start signal.</li> <li>If the parameter unit is connected, operation is also possible in the PU operation mode.</li> </ol>	<ul style="list-style-type: none"> <li>Parameter unit (FR-PU03)</li> <li>Connection cable (FR-CBL) Connect the cable if the parameter unit is to be used as a hand-held unit for operating the inverter.</li> </ul>	<ul style="list-style-type: none"> <li>Start signal Switch, relay, etc.</li> <li>Frequency setting signal can be a variable resistor or external signals which input one of the following: 0 to 5 VDC, 0 to 10 VDC, 4 to 20mA</li> <li>PU (FR-PU03)</li> <li>Connection cable (FR-CBL) Connect the cable if the parameter unit is used as the hand-held unit for operating the inverter.</li> </ul>
Connection examples	 <p>Inverter</p> <p>PU</p> <p>Start switch</p> <p>Variable resistor</p>	 <p>Inverter</p> <p>PU</p> <p>Parameter unit</p> <p>PU</p> <p>Connection cable</p>	 <p>Inverter</p> <p>PU</p> <p>Parameter unit</p> <p>PU</p> <p>Connection cable</p> <p>Start switch</p> <p>Variable resistor</p>

\* The parameter unit, hereinafter referred to as the PU, is an optional keypad used for programming and/or operating the inverter. (Refer to page 4)

## 5. INSTALLATION

### Install the inverter in the upright position.

The inverter must be installed in an upright position to allow sufficient heat radiation. Installations other than vertical, or obstructions in the cooling air path, will cause over heating and reduced service life.

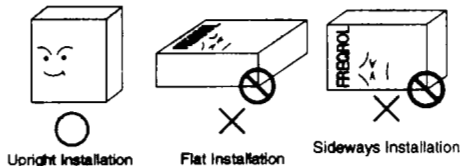

### Keep ambient temperature within the permissible temperature range.

If the inverter is installed in surroundings of high temperature, or installed inside an enclosure without adequate cooling the service life will be significantly reduced.

To install the inverter inside an enclosure, consider the cooling method as well as the dimensions of the enclosure necessary for adequate heat dissipation.

- Permissible temperature range  $-10^{\circ}\text{C}$  ( $14^{\circ}\text{F}$ ) to  $+50^{\circ}\text{C}$  ( $122^{\circ}\text{F}$ ) (The fully closed specification product is  $-10^{\circ}\text{C}$  ( $14^{\circ}\text{F}$ ) to  $+40^{\circ}\text{C}$  ( $104^{\circ}\text{F}$ )).
- Points where ambient temperature is measured

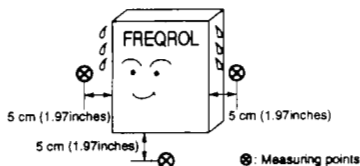

- Minimum clearance around the inverter

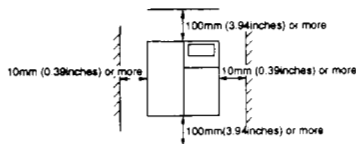

### Avoid installing the inverter in the following places.

- Places subject to direct sunlight.
- Humid air (above 90% noncondensing)

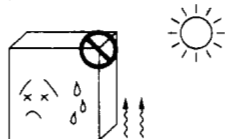

- Places with airborne oil mist, dust, or lint. Places exposed to corrosive gas. Places exposed to salt laden air.

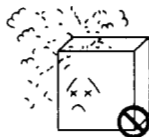

- Places subject to vibration.

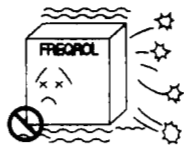

- Places exposed to explosive gas.



- On a surface of inflammable material such as wood.

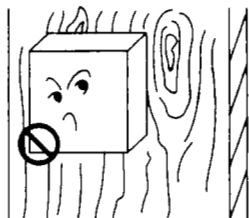

## 6. WIRING

### 6.1 Precautions

When wiring, consider the following items to avoid erroneous operation, damage or incorrect usage to the inverter.

#### Cautions on Wiring

- (1) Do not connect the power supply wires to the output terminals (U, V, W) of the inverter. If they are connected to these terminals, it will damage the inverter.
- (2) Terminals P and PR are used for connection of the optional brake resistor (refer to page 131). Never short circuit or connect anything other than the brake resistor across these terminals.
- (3) Use sleeved solderless terminals for the connection of the power supply and the motor.
- (4) Common terminals SD, 5, and SE in the terminal block for the control circuit are not at the same potential. Do not connect or ground these terminals.
- (5) Use only shielded or twisted cables to connect the control circuits. These wires must be routed as far as possible from the main power and AC relay logic circuits.
- (6) During wiring, close the slots on the top of the inverter with a cover so that cut pieces of wire will not enter the inverter.
- (7) If modification of the wiring or other work becomes necessary after operating the inverter, do not touch the wire or terminals until power is disconnect and the POWER CHARGE indicating lamp is extinguished for at least two minutes.
- (8) Any person who is involved in the wiring of this equipment should be fully competent to carry out the work.

#### Wire Size and Wiring Distance

- (1) If the motor is installed a long distance from the inverter, available motor torque will be reduced due to voltage drop in the motor cable, especially when the motor is operating at low frequencies. Select the wire size so that voltage drop is less than 2%.
- (2) At extreme distances, the charging current generated due to floating capacity between the wires may trigger the current limit function. To avoid this problem, the maximum wiring distance should be limited to the values given in the following table. If the application requires wiring longer than the permissible limits, refer to page 55.

Inverter Capacity	0.1K	0.2K	0.4K	0.75K	1.5K	2.2K	3.7K
Non low-noise operation	200m (656.2 feet)	200m (656.2 feet)	300m (984.2 feet)	500m (1641 feet)	500m (1641 feet)	500m (1641 feet)	500m (1641 feet)
Low noise operation	30m (98.4 feet)	100m (328.1 feet)	200m (656.2 feet)	300m (984.2 feet)	500m (1641 feet)	500m (1641 feet)	500m (1641 feet)

#### Note: 1meter (m) - Appx. 3 feet

The total wiring length must be 500 m (1641 feet) or less.

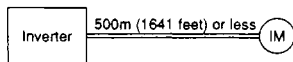

$$300\text{m (984.6 feet)} + 300\text{m (984.6 feet)} = 600\text{m (1969.2 feet)}$$

## 6. WIRING

### Items to Be Checked when Designing an Application

- (1) If the application has a commercial power supply selector circuit as shown in the illustration to the right, accidental connection of line power to the inverter output terminals will damage the inverter. To avoid this problem, interlock MC1 and MC2 both electrically and mechanically.
- (2) At an occurrence of power interruption, if the start signal (start switch) is retained ON with the frequency instruction retained, the inverter will restart automatically when power is restored. If restarting of the inverter is not desired on power restoration, it is necessary to install a magnetic contactor (MC) at the primary side of the inverter as well as to design a control sequence that disables the start signal.
- (3) Low level signals are used in the control circuit. Use dry contacts, two contacts arranged in parallel, or a twin-contact to prevent defective contacting.
- (4) Do not input voltage to contact input terminals (STF, for example) of the control circuit.
- (5) Do not apply voltage directly to the alarm output signal terminals (A, B, C) without a relay coil or lamp.
- (6) If, according to the application, an open collector output such as an output from a programmable controller is connected directly to the inverter input terminal, use terminal PC (external transistor common).

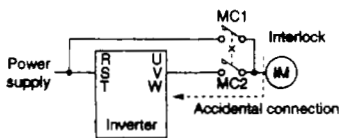

#### ● How to use terminal PC

Connect the external power supply common for transistor output signals to terminal PC to prevent malfunctioning due to undesirable current.

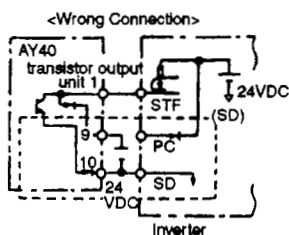
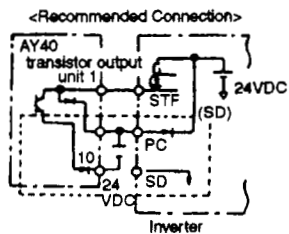

**Note:** For type AY40 unit, it is necessary to install 24 VDC power supply.



## 6. WIRING

If terminal PC is not used, the following measures are necessary to prevent generation of undesirable current.

### • Measures

- 1) Insert a diode to prevent undesirable current.
- 2) Use output module having independent output points.  
(Example: AY40A)
- 3) Use external power supply with a higher supply voltage than the inverter power supply.

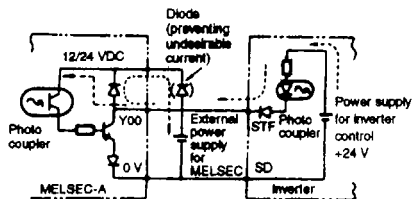

## 6. WIRING

### 6.2 Connecting the Power Supply and Motor

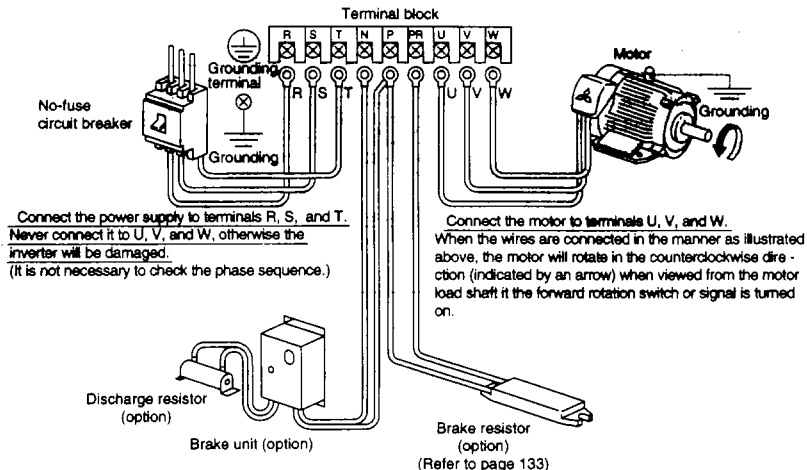

⚠ Do not use the optional brake unit and brake resistor simultaneously.

- Notes:**
- Terminal block (Configuration of the terminal block varies depending on the inverter capacity.)
    - Arrangement of terminals . . . . . See the illustration above.
    - Screw size . . . . . M3.5 screws (FR-A024-0.1 K to 1.5 K), (FR-A044-0.4K to 1.5K)  
M4 screws (FR-A024-2.2 K, 3.7 K), (FR-A044-2.2K, 3.7K)
    - Specification of terminals . . . . . Refer to "Specifications of Terminals" (page 123).
  - Grounding terminals (Configuration of the terminal block varies depending on the inverter capacity.)
    - Arrangement of grounding terminals . . . . . Two terminals beneath the terminal block
    - Screw size . . . . . M3.5 screws (FR-A024-0.1 K to 1.5 K), (FR-A044-0.4 K to 1.5 K)  
M4 screws (FR-A024-2.2 K, 3.7 K), (FR-A044-2.2 K, 3.7 K)
    - Solderless terminals (If grounding wire is connected using the solderless terminals) . . . . . Nominal size 2-3.5 (FR-A024-0.1 K to 1.5 K), (FR-A044-0.4 K to 1.5 K)  
Nominal size 2-4 (FR-A024-2.2 K, 3.7 K), (FR-A044-2.2 K, 3.7 K)
  - Wire size  
Refer to "Selection of Peripheral Devices" (page 128)

## 6. WIRING

### 6.3 Connecting the Control Signals

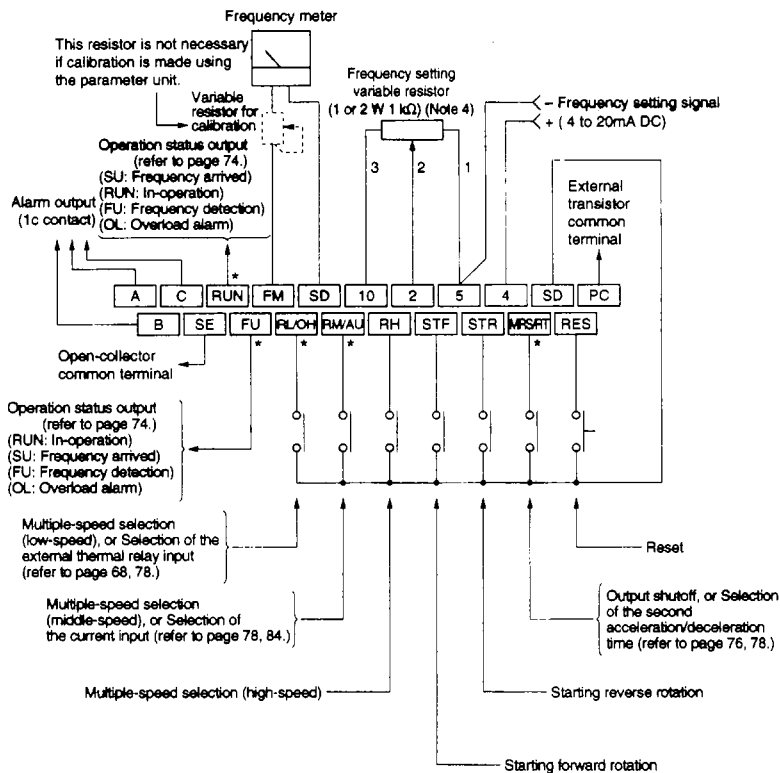

#### Notes:

- Terminal block
  - Arrangement of terminals ...See the illustration above (in two rows).
  - Screw size ..... M3 screws
- For the terminals indicated by an asterisk (\*), input or output specifications may be changed by changing the setting for the corresponding parameter.
- Two SD terminals are internally connected.
- If frequency setting must be changed frequently, it is recommended to use 2 W, 1 kΩ resistor.

## 6. WIRING

### 6.4 Operating the Inverter Using Single-Phase Power Supply

If single-phase power supply is used to operate the inverter only 2/3 of the diodes will be used, and ripple current of the capacitor will increase compared to operation with three-phase power supply, resulting in higher temperature rise of the converter and the capacitor. Operating the inverter using a single-phase power supply requires derating the output current.

#### • Rating for inverter operation using single-phase power supply

Model	FR-A024-0.1 K	FR-A024-0.2 K	FR-A024-0.4 K	FR-A024-0.75 K	FR-A024-1.5 K	FR-A024-2.2 K	FR-A024-3.7 K
Rated output current (A), 3 $\phi$	0.4	0.8	1.5	3	4	5	7
Rated output voltage	three-phase 200 to 230 VAC 50/60Hz						
Power supply voltage	single-phase 200 to 230 VAC 50/60Hz						
Power supply capacity (kVA)	0.4	0.8	1.5	2.5	4.5	5.5	9
AC input current (A), 1 $\phi$	1.1	2.4	4.5	7.6	11.2	12.9	17.4

#### • Cautions on operating the inverter using single-phase power supply

- (1) Connect the single-phase power supply to the terminals R and S of the inverter.
- (2) If capacity of the power supply is insufficient, the output voltage will become unstable under changing load conditions. Therefore, be certain the power supply is adequate.

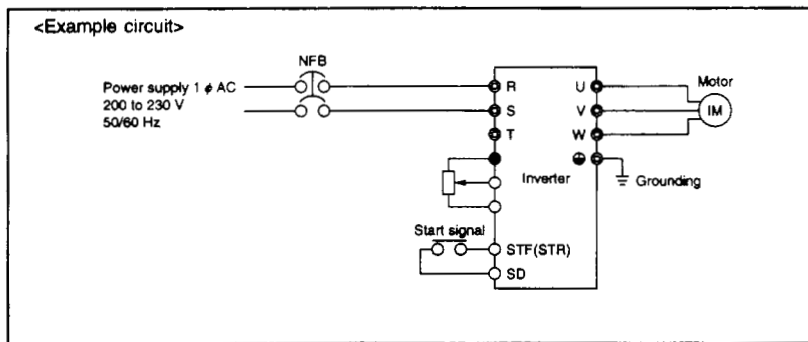

## 6. WIRING

### 6.5 Wiring procedures

- **Standard specifications (FR-A024-0.1K (P) ~ 1.5K (P), FR-A044-0.4K (P), 0.75K (P))**

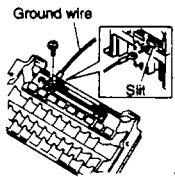
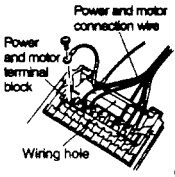
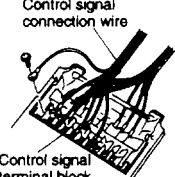
 <p>Ground wire</p> <p>Slit</p> <p>1</p>	<p>Remove the front cover of the inverter, pass the ground wire through the slit on the unit, and connect to the position shown in the drawing.</p>	 <p>Power and motor connection wire</p> <p>Power and motor terminal block</p> <p>Wiring hole</p> <p>2</p>	<p>Pass the power and motor connection wires through the wiring hole on the unit, and connect to the motor terminal block.</p>
 <p>Control signal connection wire</p> <p>Control signal terminal block</p> <p>3</p>	<p>Connect the control signal connection wire to the control signal terminal block as shown in the drawing. After wiring, install the front cover of the unit.</p>		

- **Fully closed specifications (FR-A024-0.1K (P)-C ~ 1.5K (P)-C, Not launched in North America.)**

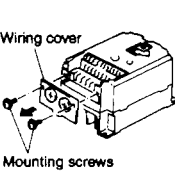
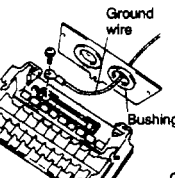
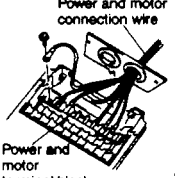
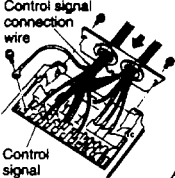
 <p>Wiring cover</p> <p>Mounting screws</p> <p>1</p>	<p>Remove the front cover of the inverter, remove the two mounting screws, and then remove the wiring cover.</p>	 <p>Ground wire</p> <p>Bushing</p> <p>2</p>	<p>Pass the ground wire through the bushing on the wiring cover, and connect it with the direction shown in the drawing.</p>
 <p>Power and motor connection wire</p> <p>Power and motor terminal block</p> <p>3</p>	<p>Pass the power and motor connection wires through the bushing on the wiring cover, and connect to the power and motor terminal block as shown in the drawing.</p>	 <p>Control signal connection wire</p> <p>Control signal terminal block</p> <p>4</p>	<p>Pass the control signal connection wire through the bushing on the wiring cover, and connect to the control signal terminal block as shown in the drawing. After wiring, install the wiring cover with the two mounting screws, and then install the front cover of the unit.</p>

## 6. WIRING

### ● Standard specifications (FR-A024-2.2K (P), 3.7K (P), FR-A044-1.5K (P) – 3.7K (P))

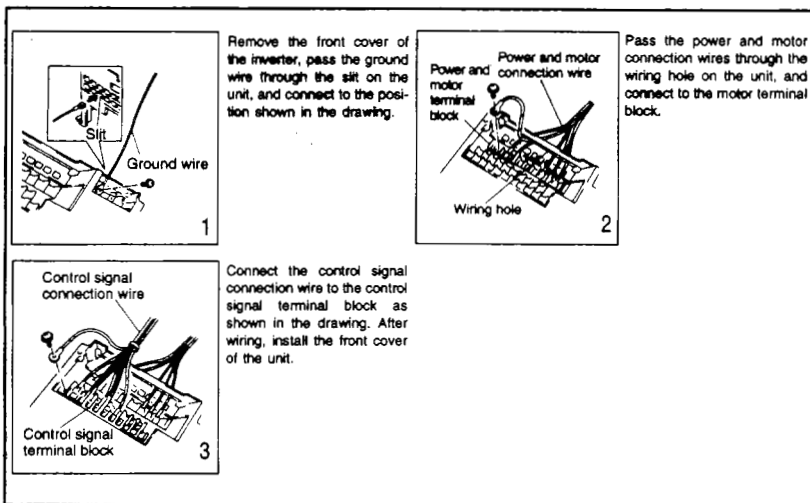

### ● Fully enclosed specifications (FR-A024-2.2K (P) - C, 3.7K (P) - C, Not launched in North America)

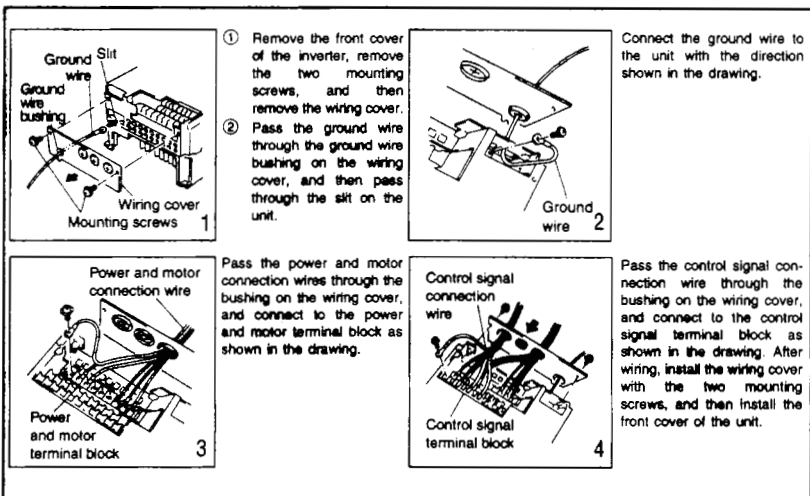

## 7. SETTING PARAMETERS BEFORE STARTUP

The major parameters to be set, and the functions of these parameters, are explained in the following table. Set the parameters according to the application requirements (load and operation specifications).

For details of the setting procedure, refer to page 38. Refer to page 57 for a complete list of parameters. The term "Pr." is an abbreviation for parameter.

### ■ Setting the parameters

Set the parameters using the parameter unit. Refer to page 38 for operating instructions.

Item	Description	Related parameters						
Selection of frequency reference signal: 0 – 5 VDC (or) 0 – 10 VDC	<p>Connect frequency reference voltage signal between terminals 2 (+) and 5 (common). Set Pr.73 for a 5 or 10V signal as shown below. (A changeover connector and 10 V power supply are not provided in the inverter.)</p> <table border="1" style="width: 100%; border-collapse: collapse;"> <thead> <tr> <th style="width: 50%; text-align: center;">0 to 10 VDC</th> <th style="width: 50%; text-align: center;">0 to 5 VDC</th> </tr> </thead> <tbody> <tr> <td style="text-align: center;">Set "1" in Pr.73</td> <td style="text-align: center;">Set "0" in Pr.73 (factory-setting before shipping).</td> </tr> <tr> <td style="text-align: center;"> </td> <td style="text-align: center;"> </td> </tr> </tbody> </table> <p>Note: If a frequency setting variable resistor (potentiometer) is connected, selection must be "0 to 5 VDC". Use terminal 10 if internal power supply is used.</p>	0 to 10 VDC	0 to 5 VDC	Set "1" in Pr.73	Set "0" in Pr.73 (factory-setting before shipping).			<p>Selection for 0 to 5V / 0 to 10V (Pr.73) Refer to page 84</p>
0 to 10 VDC	0 to 5 VDC							
Set "1" in Pr.73	Set "0" in Pr.73 (factory-setting before shipping).							
Frequency reference signal 4 to 20mA	<p>Connect 4 – 20mA reference between terminals 4 (+) and 5 (common). Connect a switch between terminals RM/AU, and SD, or a jumper if only the 4 – 20mA signal will be used. Set Pr.74 to 1 (see page 84). With the switch closed, the inverter will follow the 4 – 20mA signal; open the switch to follow a voltage reference.</p>	<ul style="list-style-type: none"> <li>● Current input signal selection (Pr.74)</li> <li>Refer to page 84</li> </ul>						
Maximum output frequency	<p>Setting this parameter is required only when the inverter is operated at a maximum frequency other than the factory setting. Setting is necessary if the inverter is operated at a frequency higher than 60Hz by an external input signal.</p> <p>&lt;Factory setting&gt;</p> <ul style="list-style-type: none"> <li>● Frequency for 5V input.....60Hz at 5 VDC (or 10VDC)</li> <li>● Frequency for 20mA input: 0Hz at 4mA DC, and 60Hz at 20mA</li> <li>● Upper limit frequency.....120Hz</li> </ul>	<ul style="list-style-type: none"> <li>● Voltage ref., 5V or (10V) input (Pr.38)</li> <li>● Current ref., 4 – 20mA input (Pr.39)</li> <li>● PU operation mode Upper frequency limit (Pr.1)</li> </ul>						

**Note:** 1. All signal and low level control wiring must be shielded type. Shields on signal wiring (0 – 5V, 0 – 10V, and 4 – 20mA) must be terminated at terminal 5 on the inverter end only.

Shields on control wiring must be terminated at terminal SD on the inverter end only. (Refer to wiring information, page 11, and wiring diagram, page 113)

## 7. SETTING PARAMETERS BEFORE STARTUP

Item	Description	Related Parameters
Upper and lower frequency limits	<p>Setting these parameters is required when the range of output frequency is to be restricted to values other than established in the V/Hz ramp.</p> <p>Example 1 – A pump, for mechanical reasons, must never operate at a frequency below 30Hz. Solution: set Pr.2 to 30Hz. When the inverter is in the run mode it will not output less than 30Hz even though the applied frequency reference command drops below 30Hz.</p> <p>Example 2 – A centrifugal fan draws excessive current at maximum speed because the motor is undersized for the application. A centrifugal fan load reduces as speed is reduced. It was found, by gradually reducing speed, that the current could be reduced to an acceptable level at 55Hz. Setting a maximum level of 55Hz in Pr.1 will limit the inverter output to this level even though the applied frequency reference rises above 55Hz.</p> <p>Note: If the lower limit frequency is set, the motor will run at the set frequency when the start signal is turned ON.</p>	<ul style="list-style-type: none"> <li>● Upper limit (Pr.1)</li> <li>● Lower limit (Pr.2)</li> </ul>
Electronic thermal overload relay	<p>The electronic overload relay function follows an algorithm based on the inverse time protection curves developed for separate motor overloads. The electronic overload relay, by virtue of knowing the output frequency at all times, has the added advantage of reducing the time to trip as the frequency to the motor is reduced. Common motors have fans that are connected to the motor shaft, so have reduced cooling capacity as speed is reduced. The factory setting is the inverter full load amp. rating, except the 0.1 – 0.75K models are set at 85% of their rating.</p> <p>Set the value to the current at the motor's rating nameplate 50 Hz.</p> <p>Note: The operation characteristics use the Mitsubishi standard squirrel-cage motor as a reference. This cannot be applied to a special motor, so protect the motor with an external thermal relay, etc.</p>	<ul style="list-style-type: none"> <li>● Electronic thermal relay (Pr.9)</li> <li>● Selection of applied load (Pr.14)</li> <li>● Selection of external thermal relay input (Pr.17)</li> </ul>
Acceleration/ deceleration time	<p>When accelerating or decelerating at a time other than the factory-set value, change this time.</p> <p>&lt;Factory-setting for acceleration/deceleration time&gt; is 5 sec.</p> <p>Note: The set value indicates the time the drive will take to accelerate to the frequency stored in Pr.20.</p>	<ul style="list-style-type: none"> <li>● Acceleration time (Pr.7)</li> <li>● Deceleration time (Pr.8)</li> <li>● Second acceleration/ deceleration time (Pr.44)</li> <li>● Second deceleration time (Pr.45)</li> </ul>

### Calibrating the Frequency Meter

Calibrate the frequency meter before starting operation so that the output status can be monitored correctly. When the parameter unit is used, the frequency meter can be calibrated precisely. (Refer to page 49 for details of calibration procedure.)

### Using the Inverter that was Used Before

If an inverter which has been used before is to be used, the set values of the parameters might have been changed according to a specific operation. Therefore, it is necessary to initialize the parameter set values before starting the operation. The term initialize refers to the operation to reset the parameter values to the factory-setting values.

The parameter unit can be used to initialize the parameter set values. (Refer to page 39 for details of initialization procedure.)

Remember that the following parameters cannot be initialized by the parameter clear operation using the parameter unit. For these parameters, change the parameter set value to the required value after reading the current setting, or reset the parameters to the factory-setting by the all clear operation.

- Pr.900 "FM terminal calibration"
- Pr.905 "Gain for frequency setting current"
- Pr.902 "Bias for frequency setting voltage"
- Pr.38 "Frequency at 5V (10V) input"
- Pr.903 "Gain for frequency setting voltage"
- Pr.39 "Frequency at 20 mA input"
- Pr.904 "Bias for frequency setting current"
- Pr.75 "Reset selection/detection of parameter unit disconnection"



## 8. NOMENCLATURE OF PARAMETER UNIT

The parameter unit, model FR-PU03E can be directly installed to the FR-A024 series inverters or connected with an optional cable. Functions of the parameter unit are: to operate the inverter, set the parameters (read, write), monitor the operation status, and display alarm contents. The parameter unit (FR-PU03E) is hereinafter referred to as the "PU". The parameter is hereinafter referred to as the "Pr."

### Display unit

The 4-digit, 7-segment display gives the following information: frequency, motor current, set values for parameters, alarm messages, etc.

### Operation mode indicating lamps (MONITOR, SET, EXT.OP, PU OP)

When an operation mode selection key is pressed, the indicating lamp corresponding to the pressed key lights to indicate the selected operation mode.

- Simple operation keys

### Setting value adjust keys

The keys are used to adjust (increase, decrease) the set values for the operation frequency, parameters, etc.

The set value continues to increase or decrease as long as the key is pressed.

### Clamp screw

The screw clamps the parameter unit to the inverter.

### Cover (detachable)

When using keys other than the simple operation keys, it is necessary to open the cover. The cover should be kept closed to prevent tampering or accidental operation.

### Function (parameter) and numeric keys

These keys select the basic function (parameter), change parameter values, enter frequencies, scroll through faults and various measured data, volts, amps, etc.

### Monitor mode indicating lamps

These lamps indicate the contents of the display such as output frequency and output current.

### Operation indicating lamp (forward, reverse)

The indicating lamp blinks when the motor rotation direction command is input either from the parameter unit key (FWD or REV key) or from an external device.

### Operation command keys

These keys are used to control the operation from the parameter unit: forward, reverse, stop.

### Mode selection keys

These keys are used to select the mode of operation, which includes operation controlled by the parameter unit, operation by the external signals, jog operation, read and write parameters, monitor output frequency, output current and alarms.

### Write key

This key is used to enter the set value in memory. After setting a value or changing the current setting for parameters and operation frequency, press this key to write it.

### Read key

This is a dual function key used to:

1. Fetch and display the contents of a parameter (address in memory).
2. Set a decimal point.

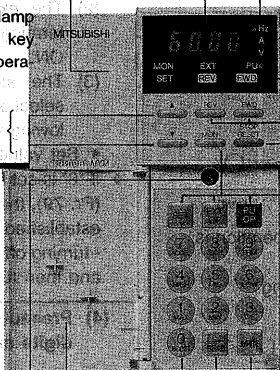

## 9. PRECAUTIONS ON OPERATING THE PARAMETER UNIT

When operating the parameter unit, if review the following precautions - - the set value cannot be written or a wrong value is written.

### (1) Precautions for operating the inverter by the parameter unit

- Inverter operation using the parameter unit is enabled only when the [PU OP] key is pressed or the PU operation or combination operation mode is selected by Pr. 79.



- In the monitor mode (MONITOR mode lamp is lit), the operation frequency cannot be set.

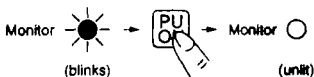

- In the following cases, jog operation is not possible.

(1) While the motor is running.

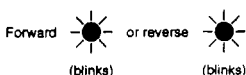

To execute jog operation, stop the motor first.

(2) If the setting for jog frequency (Pr. 15) is lower than the setting for operation start frequency (Pr. 13).

### (2) Precautions for monitoring

- While operating the motor from the parameter unit, when the start key ([FWD] or [REV]) is pressed after setting the operation frequency, the mode automatically switches to the monitor mode.

### (3) Precautions for operation

- In the following cases, the operation mode cannot be switched by pressing the [PU OP] or [EXT OP] key.

(1) While the motor is running.

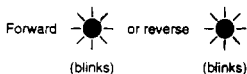

(2) The external start signal (across terminals STR or STF, and SD) is ON.

(3) The setting for operation mode selection (Pr. 79) is any of the following values.

- Set value: 1 to 4, 7, 8
- If "0" is set for operation mode selection (Pr. 79), the external operation mode is established if the following is attempted - turning off power supply to the inverter and then turn it on again, or resetting.

### (4) Precautions for the number of digits and a decimal point

- The maximum number of digits for a value to be input is 4. If a value is input exceeding this limit, the most significant digit is ignored. See the example below.

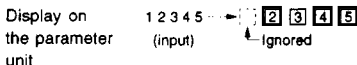

### (5) Precautions for setting the operating frequency

- When the operation frequency has been set using the [▲] and [▼] keys (step setting) or directly (direct setting), setting is allowed only in the range established by the upper limit and lower limit frequencies.

## 9. PRECAUTIONS ON OPERATING THE PARAMETER UNIT

### (6) Cautions on writing the set values

- Writing is possible only in the PU operation mode (Pr.79 = 0, 1).  
In the external or combined operation mode, it is not possible to write the set value. Remember that "reading" is possible in any of these operation modes. However, even in the external or combination operation mode, writing is possible for the following parameters.
  - (1) 3-speed setting ..... Pr.4 to Pr.6
  - (2) Multiple-speed setting ..... Pr.24 to Pr.27, Pr.126 to Pr.133
  - (3) Display function .... Pr.54 to Pr.56
  - (4) Selection of operation mode Pr.79
  - (5) FM terminal calibration .... Pr.900
  - (6) Frequency setting bias and gain (voltage, current) ..... Pr.902 to Pr.905
  - (7) Key click sound selection .. Pr.990
  - (8) Alarm clear ..... Pr.996
  - (9) Inverter reset ..... Pr.997
- In the factory-setting status (pr.77 = 0), writing is not possible while the motor is running. If writing is attempted in this status, the error message (Err.) is displayed. However, writing is possible for the following parameters while the motor is running.
  - (1) 3-speed setting ..... Pr.4 to Pr.6
  - (2) Multiple-speed setting ..... Pr.24 to Pr.27, Pr.126 to Pr.133
  - (3) Tone modulation control selection ..... Pr.61
  - (4) PWM frequency selection ... Pr.72
  - (5) Display function .... Pr.54 to Pr.56
  - (6) Parameter write disable selection ..... Pr.77
  - (7) FM terminal calibration .... Pr.900
  - (8) Frequency setting bias and gain (voltage, current) ..... Pr.902 to Pr.905
  - (9) Key click sound selection .. Pr.990
  - (10) Alarm clear ..... Pr.996
  - (11) Inverter reset ..... Pr.997
- In addition to the cases indicated above, writing of the set values is disabled in the following cases as well. If writing is attempted in these cases, the error message (Err.) is displayed.
  - (1) Parameter write disable selection (Pr.77) is set for "disable".
  - (2) A parameter number not given in the parameter list (page 57) is selected.
  - (3) A value outside the permissible setting range is set.
  - (4) A value outside the range established by the upper and lower limits of frequency (Pr.1 and Pr.2) is set.
- If the error message (Err.) is displayed when writing is attempted, repeat the operation from the beginning after pressing the [SET] key.



## 10. OUTLINE OF THE FUNCTIONS

---

The parameter unit has the following functions.

### ● Selecting the operation mode

- (1) External operation mode  
Operation using a frequency setting variable resistor, start switch, and other external devices. .... p.28
- (2) PU operation mode  
Operation using the keys on the parameter unit. .... p.29
- (3) Combination operation mode  
Operation by combining the external signals and parameter unit keys.  
Inputting the external start signal while using the parameter unit to set the operating frequency etc. .... p.31

### ● Setting the parameters

- (1) Reading the current setting  
To check the value of a parameter. .... p.38
- (2) Updating the setting  
To change the value of a parameter. .... p.38
- (3) Returning the parameter values to the factory-settings before shipping (initialization)  
Parameter clear, parameter all clear .... p.40
- (4) Disabling parameter write function .... p.86
- (5) Calibrating the frequency meter .... p.49

### ● Monitoring

- (1) Checking the operation status .... p.41
  - Output frequency (Hz)
  - Output current (A)
  - Rotation speed (m/min)
  - Motor rotating direction (forward, reverse)
  - Motor in-operation
- (2) Checking the contents of alarm .... p.103

## 11. OPERATION

### 11.1 Operation Modes

The operation mode of the inverter is classified into the following three modes – the external operation mode in which the inverter operation is controlled by the external signals, the PU operation mode in which the inverter operation is controlled by the parameter unit, and the combined operation mode in which the inverter operation is controlled by both the external signals and the parameter unit.

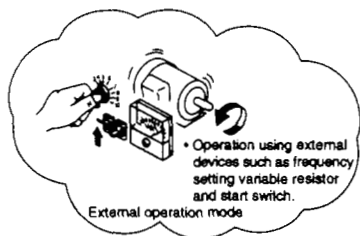

#### ■ Factory-set operation mode

When power is turned ON or when the inverter is reset, the operation mode is set to "operation using external input signals". Therefore, the inverter can be operated using the external signals when it is turned ON. The inverter starts operating if the start signal (STF/STR and SD) is turned ON in this state. A speed reference signal is also required for motor rotation.

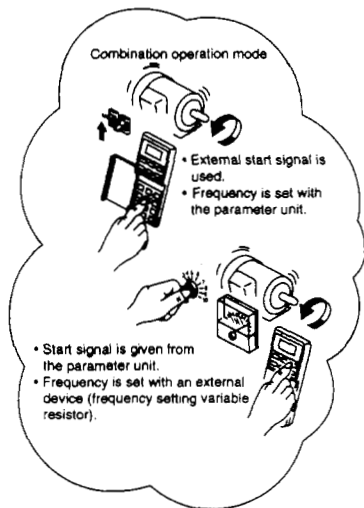
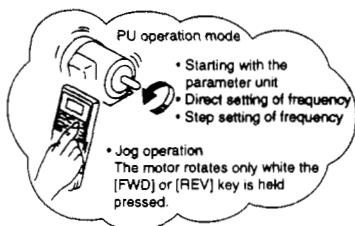

#### ■ To fix the operation mode

It is possible to set the operation mode which is established when power is turned ON. For example, if the inverter needs to be operated only in the PU operation mode, it is possible to set the PU operation mode as the mode to be established when power is turned ON. In this state, there is no need to press the operation mode selection key to select the PU operation mode after turning ON power. The procedure to set the default mode for the mode which is established when power is turned on is explained on page 27.

# 11. OPERATION

## 11.2 Selecting the Operation Mode

External operation is the factory set operation mode when power is switched on. To change the operation mode, use the mode selection keys on the parameter unit.

### ● Changing from the external operation mode to the PU operation mode:

Make sure that the external input signal across terminals STF/STR and SD is OFF. Then, press the [PU OP] key, and the operation mode is changed to the PU operation mode.

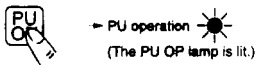

### ● Changing from the PU operation mode to the external operation mode:

Make sure that the external input signal across terminals STF/STR and SD is OFF, and that both of the FWD and REV indicating lamps are not lit.

Then, press the [EXT OP] key, and the operation mode is changed to the external operation mode.

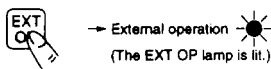

### ● Changing to the combination operation mode:

Change the value set for Pr.79 (operation mode selection) as indicated below. For the procedure used to change the value of parameters, refer to page 38.

External operation PU operation   
(Both of the EXT OP and PU OP are lit.)

Set value	Contents	
	Operation frequency setting	Start signal
3	Parameter unit ● Direct setting, or setting with [▲] [▼] keys.	Terminal signal ● STF ● STR
4	Terminal signals ● Across 2 and 5: 0 to 5 VDC ● Across 2 and 5: 0 to 10 VDC ● Across 4 and 5: 4 to 20mA DC ● Multiple-speed selection (Pr.4 to Pr.6, Pr.24 to Pr.27, Pr.126 to 133)	Parameter unit ● Forward key ● Reverse key

**Note:** By setting "8" for Pr.79 (local/auto external signal selection mode), it is possible to switch the operation mode between the PU operation mode and the external operation mode using an external signal.

## 11. OPERATION

**Notes:** If the operation mode cannot be changed correctly, check the following items.

1. External input signal . . . . . Make sure that the external run command is (STF/STR and SD) OFF. If this is ON, operation mode cannot be changed.
2. Parameter setting . . . . . Check the set value in Pr.79 (operation mode selection).

Set Value	Description
0	PU operation and external operation (selectable) (factory-setting)
1	PU operation mode only (changing to other operation mode is impossible.)
2	External operation mode only (changing to other operation mode is impossible.)
3, 4	Combination operation mode
6	Switch over mode
7	Edit enable signal mode
8	Operation mode switching is enabled by an external signal.

3. Fixing the operation mode . . . . . If the setting for Pr.79 (operation mode selection) is "0" (factory-setting) the external operation mode is established when the power is turned ON. The PU operation mode is selectable by pressing the [PU OP] key.  
With other set values (1 to 8), the operation mode is fixed according to the set value. Refer to table above.

# 11. OPERATION

## 11.3 External Operation Mode (Operation Using External Input Signals)

### ● Operation procedure (operation at 60Hz)

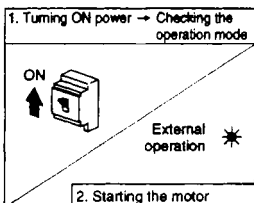

Turn ON the power (POWER indicator lamp lit) and make sure that the external operation mode indicating lamp is lit. If the indicating lamp is not lit, change the operation mode to the external operation mode by referring to the procedure given on page 26.

**Note 1:** If both of the forward and reverse switches are turned ON, the inverter will not operate. If both of these switches are turned ON during operation, the motor stops running after decelerated.

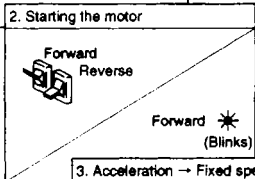

Turn ON the start switch (closing the circuit across terminals STF/STR and SD) (Note 1). The forward or reverse rotation indication lamps begin blinking, indicating that the corresponding signal is output.

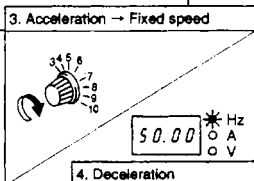
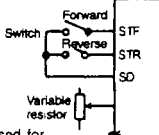

Turn the variable resistor (used for setting the frequency) clockwise gradually to the end position. The frequency displayed in the display unit increases as the variable resistor is turned and will reach 60Hz. (default Values)

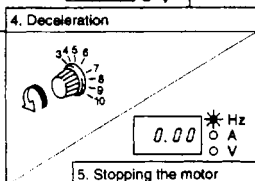

Turn the variable resistor (used for setting the frequency) counterclockwise gradually to the end position (Note 2). The frequency displayed in the display unit decreases gradually as the variable resistor is turned and will reach zero (0Hz). (default values)

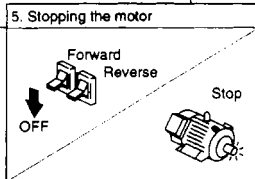

Turn OFF the start switch (opening the circuit across terminals STF/STR and SD). The motor stops running. For 3 wire control with momentary operation switches see note 3.

**Note 2:** If the start switch is turned OFF while the variable resistor is placed in the rightmost position, the motor decelerates and stops. Although noise due to high frequency will be generated just before the stop because DC injection braking is working, this does not indicate abnormal operation.

**Note 3:** The start signal selfholding function can be selected. (For details, see Pr.59 page 78)

- The inverter will start when STF (STR) is input.
- The operation will continue even if STF (STR) is released after that.
- To stop, release STOP-SD with the stop switch. The inverter will stop.

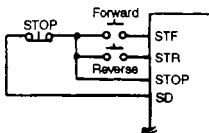



# 11. OPERATION

## 11.4 PU Operation Mode (Operation Using the Parameter Unit)

### (1) Ordinary operation

By repeating items 2 and 3 below while the motor is running, it is possible to change the motor speed.

### ● Operation procedure (operation at 60Hz)

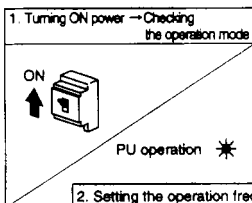

Turn ON the power (POWER indicator lamp lit) and press the [PU OP] key. Make sure that the PU operation mode indicating lamp is lit.  
If the indicating lamp is not lit, change the operation mode to the PU operation mode by referring to the procedure given on page 26.

**Note 1:** The operation frequency is directly set using the numeric keys after pressing the [PU OP] key. Direct setting is not possible in the monitor mode. To set the operation frequency directly while the inverter is in the monitor mode, cancel the monitor mode by pressing the [PU OP] key and set the new operation frequency.

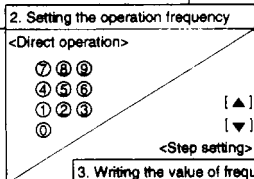

Set the operation frequency at 60Hz.

- Direct setting (Note 1)
- Step setting (Note 2)
- Step setting (Note 3)

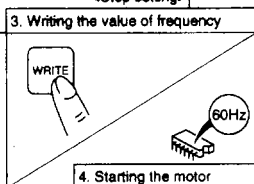

Press the [WRITE] key.  
Be sure to press the [WRITE] key after setting the frequency.  
The set value is not stored to the memory if it is not pressed.

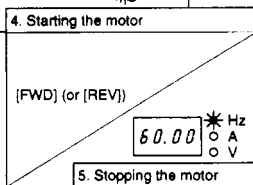

Press either the [FWD] or [REV] key.  
The motor starts running. The mode automatically changes to the monitor mode and the display unit gives the output frequency.

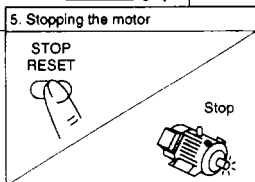

Press the [STOP] key. The motor decelerates and stops.

**Note 2:** The operation frequency is set by pressing the [▲] and [▼] keys.  
The frequency is changed only while the [▲] (or [▼]) key is held pressed. At the start of pressing the key, the frequency gradually changes to allow fine adjustment of the frequency. The frequency set in the step setting mode is automatically stored in memory 10 seconds after completion of setting.

**Note 3:** Step setting is possible while the inverter is operating.  
However, if the [▲] (or [▼]) key is pressed in the monitor mode, the frequency value being adjusted does not stop immediately even when the key is released, but it continues changing. (Since the [▲] and [▼] keys increase and decrease the frequency, an error is generated in the monitor mode.)

## 11. OPERATION

### (2) Jog operation

For the procedure to be followed after changing the parameter set value, refer to page 38.

#### • Operation procedure (jog operation at 8Hz)

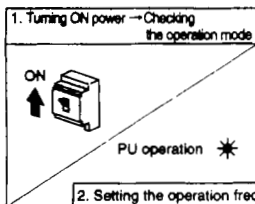

Turn ON the power (POWER indicator lamp lit) and press the [PU OP] key. Make sure that the PU operation mode indicating lamp is lit.  
If the indicating lamp is not lit, change the operation mode to the PU operation mode by referring to the procedure given on page 26.

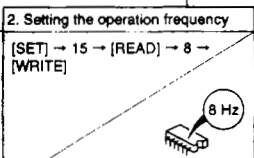

Set the operation frequency used for jog operation in Pr.15 (jog frequency). (Note 1)

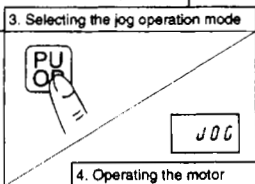

Press the [PU OP] key two times. The jog operation mode is selected and "JOG" is displayed in the display unit.

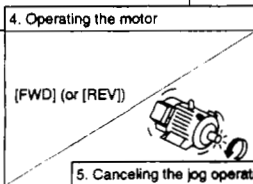

Press the [FWD] or [REV] key. The motor runs while the key is held pressed and it stops running when the key is released. (Note 2)

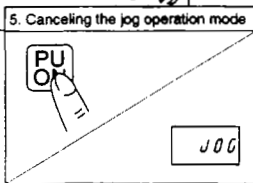

Press the [PU OP] key. The jog operation mode is canceled. To return to the jog operation mode using the same operation frequency, simply press the [PU OP] key.

**Note 2:** If the motor does not start running, check the setting for Pr.13 (start frequency). If the set frequency for jog operation is lower than the start frequency, the motor will not run. If the parameter unit is disconnected from the inverter during a jog operation, the inverter recognizes that the [FWD] or [REV] key is released and will decelerate and stop the motor after about 1 second.

**Note 1:** Operation frequency and acceleration/ deceleration time for jog operation can be set for parameters.  
<Factory-setting>  
● Pr.15 (jog operation frequency) .....5Hz  
● Pr.16 (acceleration/ deceleration time for jog operation.) .....0.5 sec.

## 11. OPERATION

### 11.5 Combination Operation Mode (Operation Using both External Signals and Parameter Unit)

- (1) To operate the inverter using external start signals and the operation frequency set by the parameter unit:

Therefore operation frequency set using an external device and the forward, reverse, and stop keys on the parameter unit are not functional.

Note: If the forward or reverse key is pressed on the parameter unit, the mode automatically changes to the monitor mode. In this state, the inverter does not operate although the reverse indicating lamp blinks. For the procedure to be followed after changing the parameter set value, refer to page 38.

#### ● Operation procedure (operation at 60Hz)

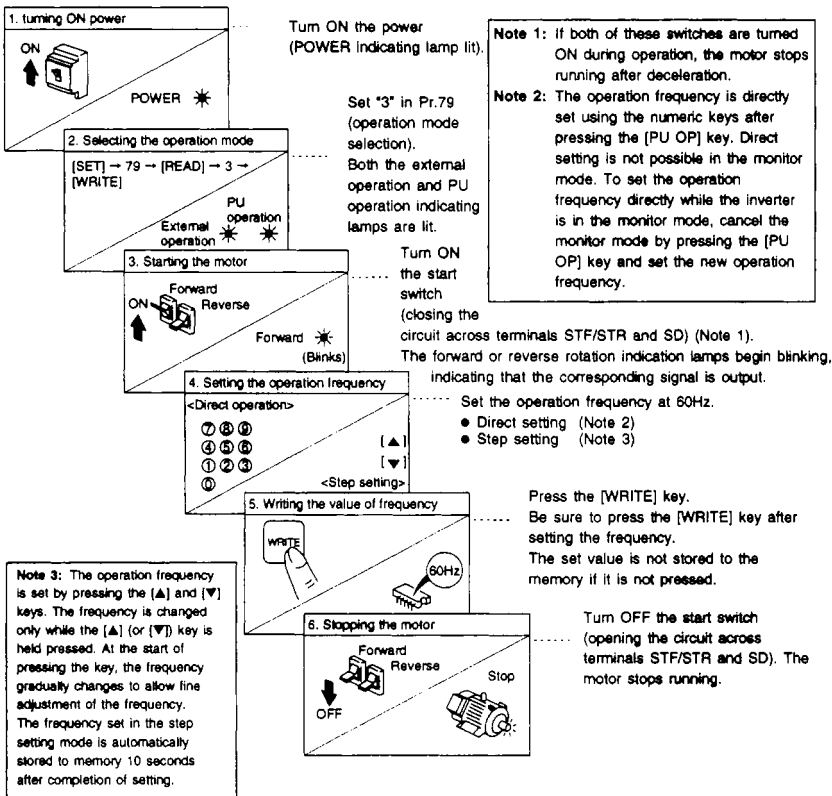

## 11. OPERATION

- (2) To operate the inverter using operation frequency set by an external device and the start and stop commands output from the parameter unit:

For the procedure to be followed after changing the parameter set value, refer to page 38.

### ● Operation procedure

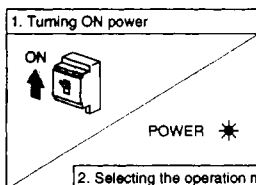

Turn ON the power (POWER indicating lamp lit).

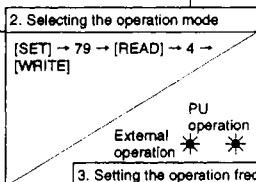

Set "4" for Pr.79 (operation mode selection). Both the external operation and PU operation indicating lamps are lit.

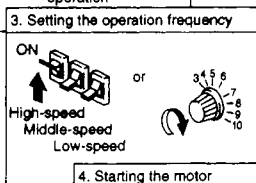

Input the operation frequency signal from an external device (multiple-speed signal selection, or frequency setting variable resistor). (Note 2)

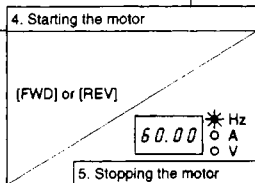

Press either the [FWD] or [REV] key on the parameter unit. (Note 1)  
The motor starts running.  
The mode automatically changes to the monitor mode and the display unit gives the output frequency.

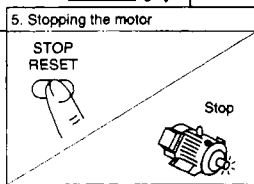

Press the [STOP] key on the parameter unit. The motor decelerates and stops.

**Note 1:** The terminals in the inverter where start signal should be input (STF, STR) are invalid. The motor will also start if the frequency setting signal is turned on after the [FWD] or [REV] key on the parameter unit is pressed.

**Note 2:** In a mode other than the monitor mode, the display unit in the parameter unit displays the frequency which corresponds to the frequency setting signal input from an external device. Note that this frequency is not displayed unless the [PU OP] key is pressed.

## 11. OPERATION

(3) To operate the inverter using the start signal and multiple-speed signal input from an external device and the speeds set by the parameter unit:

The operation is accomplished by a setting of "0" (factory-setting) in Pr.79 (operation mode selection).

For the procedure to be followed after changing the parameter set value, refer to page 38.

### • Operation procedure

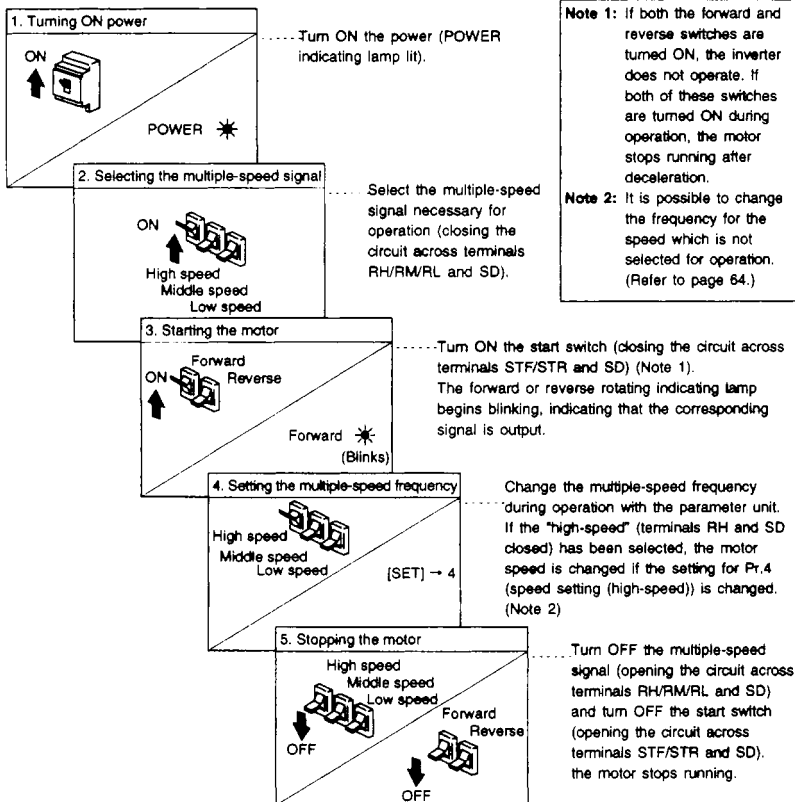

**Note 1:** If both the forward and reverse switches are turned ON, the inverter does not operate. If both of these switches are turned ON during operation, the motor stops running after deceleration.

**Note 2:** It is possible to change the frequency for the speed which is not selected for operation. (Refer to page 64.)

# 11. OPERATION

## 11.6 Switch over mode

With this mode, the external operation mode, PU operation mode and computer link operation modes can be entered while the inverter is running.

● The following mode transition functions are valid during the switch over mode.

Operation mode transition	Transition operation/operation state
External operation ↓ PU operation	<ol style="list-style-type: none"><li>① Press the PU operation key.<ul style="list-style-type: none"><li>• The rotation direction will continue to be that applied during external operation.</li><li>• The set frequency will continue to be the value set with the variable resistor (frequency setter). (Note that once the power is turned OFF or inverter is reset, that set value will be cleared.)</li></ul></li></ol>
External operation ↓ Computer link operation	<ol style="list-style-type: none"><li>① Remove the parameter unit, and install the computer link unit FR-CU03 (option).</li><li>② Transmit the command to change to the computer link mode from the computer.<ul style="list-style-type: none"><li>• The rotation direction will continue to be that applied during external operation.</li><li>• The set frequency will continue to be the value set with the variable resistor (frequency setter). (Note that once the power is turned OFF or inverter is reset, that set value will be cleared.)</li></ul></li></ol>
PU operation ↓ External operation	<ol style="list-style-type: none"><li>① Press the external operation key on the parameter unit.<ul style="list-style-type: none"><li>• The rotation direction will be decided by the external operation input signal.</li><li>• The set frequency will be decided by the external frequency setting signal.</li></ul></li></ol>
PU operation ↓ Computer link operation	<ol style="list-style-type: none"><li>① Remove the parameter unit, and install the computer link unit FR-CU03 (option).</li><li>② Transmit the command to change to the computer link mode from the computer.<ul style="list-style-type: none"><li>• The rotation direction and setting frequency will continue in the PU operation state.</li></ul></li></ol>
Computer link operation ↓ External operation	<ol style="list-style-type: none"><li>① Remove the computer link unit FR-CU03 (option), and install the parameter unit.</li><li>② Press the external operation key on the parameter unit.<ul style="list-style-type: none"><li>• The rotation direction will be decided by the external operation input signal.</li><li>• The set frequency will be decided by the external frequency setting signal.</li></ul></li></ol>
Computer link operation ↓ PU operation	<ol style="list-style-type: none"><li>① Remove the computer link unit FR-CU03 (option), and install the parameter unit.</li><li>② Press the PU operation key on the parameter unit.<ul style="list-style-type: none"><li>• The rotation direction and setting frequency will continue in the computer link operation state.</li></ul></li></ol>

## 11. OPERATION

### 11.7 Edit Enable Signal Mode

Usually, the operation mode should be changed to the PU operation mode when changing the set value for parameters. In the edit enable signal mode, changing the values set in parameters is enabled and disabled by turning ON and OFF the external signal input to the terminal MRS/RT and SD.

- In the edit enable signal mode, the following functions are available.

Set value	Signal (MRS and SD)	Function and operation
7	Closed	<ul style="list-style-type: none"> <li>• In the external operation mode, output is shut off.</li> <li>• Operation mode can be switched to the PU mode.</li> <li>• In the PU mode, set values for parameters can be changed.</li> <li>• Operation in the PU operation mode is enabled.</li> </ul>
	Open	<ul style="list-style-type: none"> <li>• Operation mode is forcibly changed to the external operation mode.</li> <li>• Operation in the external operation mode is enabled.</li> <li>• Operation mode change to the PU operation mode is disabled.</li> </ul>

Note: Setting of "7" is allowed if the setting for Pr.44 (second acceleration/deceleration time) is "9999".

The functions and operation according to ON/OFF status of the external signal (terminal MRS/RT) are summarized below.

Operation		Terminals MRS and SD	Mode Switching	Status	Parameter Write	Remark
Mode	Status					
PU	Stop	Connected ↓ Disconnected	Forcibly switched to the external operation mode. (Note 1)	Remains stopped.	Enable ↓ Disable	● Unswitchable to the PU operation mode. Note 1: Switched independently of the external start signal.
	Running	Connected ↓ Disconnected	Forcibly switched to the external operation mode. (Note 1)	If the frequency setting and start signals of external operation are on, operation is performed accordingly.	Enable ↓ Disable (Note 2)	● Unswitchable to the PU operation mode. Note 2: Limited to parameters that may be rewritten during operation.
External	Stop	Disconnected ↓ Connected	Remains in the external operation mode. (Note 3)	Remains stopped.	Disable ↓ Disable	● Switchable to the PU operation mode. Note 3: Output stopped.
		Connected ↓ Disconnected	Remains in the external operation mode.	Remains stopped.	Disable ↓ Disable	● Unswitchable to the PU operation mode.
	Running	Disconnected ↓ Connected	Remains in the external operation mode. (Note 3)	Running ↓ Output stop	Disable ↓ Disable	● Unswitchable to the PU operation mode.
		Connected ↓ Disconnected	Remains in the external operation mode.	Output stop ↓ Run (Note 4)	Disable ↓ Disable	● Switchable to the PU operation mode. Note4: If the frequency setting signal is on, operation is performed accordingly.

## 11. OPERATION

---

- Note:**
1. After turning ON the MRS terminal, if the setting for Pr.79 is changed to any value other than "7" in the PU operation mode, the MRS terminal functions as the ordinary MRS terminal (mechanical reset terminal) instead of the edit enable signal terminal. Then the operation mode is changed according to the new setting for Pr.79.
  2. When mode changed is attempted between the external operation mode to the PU operation mode with the MRS terminal ON, the mode change will not occur if the STF or STR terminal is ON.
  3. In the setting of Pr.79 = 7 with the MRS terminal ON, if the MRS terminal is turned OFF while in the PU operation mode, the operation mode is changed to the external operation mode independent of the ON/OFF status of the terminal (STF, STR). Therefore, if the MRS terminal is turned OFF while either the STF or STR terminal is ON, the motor is controlled in the external operation mode.
  4. During the operation in the PU operation mode, the ordinary MRS function does not work.
  5. When the mode is changed from the PU operation mode to the external operation mode forcibly, the parameter unit is internally reset once to secure the monitor screen.
  6. If an alarm has occurred, the inverter can be reset by pressing the stop key in the PU operation mode. Resetting of the inverter in the external operation mode is not possible. Therefore, resetting the inverter always changes the mode to the PU operation mode.



## 11. OPERATION

### 11.8 Local/Auto External Signal Selection Mode

In this mode, the operation mode can be modified by turning ON/OFF an external signal (terminal RH). Since the operation mode can be changed by the external signal, erroneous mode switching can be avoided.

Set value	Signal (RH and SD)	Fixed mode	Comment
8	Close	External operation mode	Changing to the PU operation mode is impossible.
	Open	PU operation mode	Changing to the external operation mode is impossible.

If the circuit across terminals RH and SD is closed while in the PU operation mode, the operation mode is forcibly changed to the external operation mode. If it is opened, the operation mode is forcibly changed to the PU operation mode.

Note that this mode change is possible only while the inverter is stopped. The mode change is not allowed while the inverter is operating.

**Note:** If "8" is set for Pr.79, the function of the terminal RH (multiple speed setting (high-speed)) is changed to the local/auto external selection function. In this setting, the ordinary function of the terminal RH does not work.

## 12. SETTING AND CHANGING THE PARAMETERS

For the control of an inverter, many parameters are used and it is possible to select the specific parameters necessary for inverter operation and to set proper values for the selected parameters using the parameter unit meeting the application requirements (load and operation conditions). For details of the parameters, refer to the list of parameters in page 57.

To protect the parameters from accidental alteration, set "1" for Pr.77 (Parameter write disable selection). (Refer to page 86.)

### ● Operating procedure (Reading and writing the value set in Pr.1 (upper limit frequency))

(1) Press the [PU OP] key	The PU operation indicating lamp is lit.	PU  operation
(2) Press the [SET] key	"P." appears in the display unit.	P.
(3) Input "999" using the numeric keys.	"P.999" appears in the display unit.	P. 1
(4) Press the [READ] key	The current set value is displayed in the display unit.	120.0
(5) Input the value to be set (Example: 60)	The new value is displayed in the display unit.	60
(6) Press the [WRITE] key	The new value is stored to the memory.	60.00 * Displayed alternately P. 1

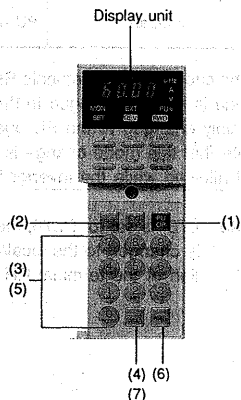

.....If the error message "Err." appears in the display unit when the [WRITE] key is pressed, refer to page 22.

- (7) When the [READ] key is pressed next, the parameter number advances to "2" (Pr.2). Press the [READ] key once again, and the current setting for Pr.2 is displayed. In the same operation, the current setting for other parameters can be read.

**Note:** Setting and changing of the parameters is accomplished in the PU operation mode. If the PU operation indicating lamp is not lit when the [PU OP] key is pressed, attempt to change the mode to the PU operation mode by referring to the procedure in page 26. Remember that the setting and changing of the following parameters is possible in the external or combination operation mode.

- 3-speed setting ..... Pr.4 to Pr.6
- Multiple-step speed setting ..... Pr.24 to Pr.27, Pr.126 to Pr.133
- Display function ..... Pr.54 to Pr.56
- Selection of operation mode .... Pr.79
- FM terminal calibration ..... Pr.900
- Frequency setting bias and gain (voltage, current) .... Pr.902 to Pr.905
- Key click sound selection ..... Pr.990
- Alarm clear ..... Pr.996
- Inverter reset ..... Pr.997

## 13. INITIALIZING THE PARAMETERS

The operation to return the set values for the parameters, excluding the calibration value, to the factory-set values (initialization) is called "parameter clear".

The operation to initialize all the parameters including the calibration value is called "parameter all clear".

### 13.1 Parameter Clear

#### • Operating procedure

(1) Press the [PU OP] key ... The PU operation indicating lamp is lit.	PU  operation
(2) Press the [SET] key ... "P." appears in the display unit.	P.
(3) Input "999" using the numeric keys. ... "P.999" appears in the display unit.	P.999
(4) Press the [READ] key ... "Pr.Cr." appears in the display unit. (Note 1)	Pr.Cr.
(5) Press the [WRITE] key ... "Pr.Cr." in the display unit blinks on and off. This completes parameter clear operation. (Note 2)	Pr.Cr. (blinking)

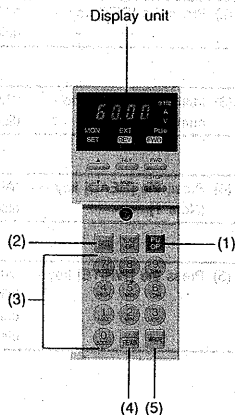

- Notes:**
1. If the [WRITE] key is pressed before pressing the [READ] key, the operation is not accepted.
  2. If the attempted parameter clear operation is rejected by the inverter, "Err." and "Pr.Cr." are displayed alternately.

**Note:** In the parameter clear operation, the following parameters are not initialized.

- Pr.900 FM terminal calibration
- Pr.903 Frequency setting voltage gain
- Pr.905 Frequency setting current gain
- Pr.39 Frequency at 20mA input
- Pr.902 Frequency setting voltage bias
- Pr.904 Frequency setting current bias
- Pr.38 Frequency at 5V (10V) input
- Pr.75 Reset selection/detection of parameter unit disconnection

**Note:** While writing of the parameters is disabled, Pr.77 = 1 or during operation in Pr.77 = 0, it is not permissible to change the value set for parameters. In this case, however, Pr.900 to Pr.905 can be changed.

## 13. INITIALIZING THE PARAMETERS

### 13.2 Parameter All Clear

#### ● Operating procedure

(1) Press the [PU OP] key ... The PU operation indicating lamp is lit.	PU * operation
(2) Press the [SET] key ... "P." appears in the display unit.	P.
(3) Input "998" using the numeric keys. ... "P.998" appears in the display unit.	P.998
(4) Press the [READ] key ... "ALLC" appears in the display unit. (Note 1)	ALLC
(5) Press the [WRITE] key ... "ALLC" in the display unit blinks on and off. This completes parameter all clear operation. (Note 2)	ALLC (blinking)

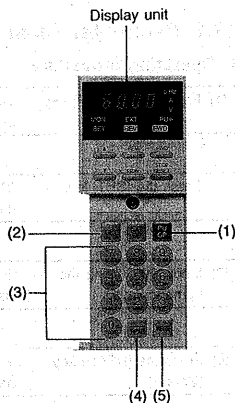

- Notes:**
1. If the [WRITE] key is pressed before pressing the [READ] key, the operation is not accepted.
  2. If the attempted parameter all clear operation is rejected by the inverter, "Err." and "ALLC" are displayed alternately.

**Note:** In the parameter all clear operation, the following parameter is not initialized.

- Pr.75 "Reset selection/detection of parameter unit disconnection"

**Note:** While writing of the parameters is disabled, Pr.77 = 1 or during operation in Pr.77 = 0, it is not permissible to change the value set for parameters. In this case, however, Pr.900 to Pr.905 can be changed.

## 14. MONITORING

Just after turning ON the power, or when the monitor key is pressed, the parameter unit enters the monitor mode. In the monitor mode, load status (output frequency, output current, etc.), protective function activation status in response to the occurrence of an alarm, etc. can be monitored.

(1) Changing the monitor information (output frequency, output current, error code)

The monitor information is changed each time the monitor key is pressed.

### ● Operating procedure

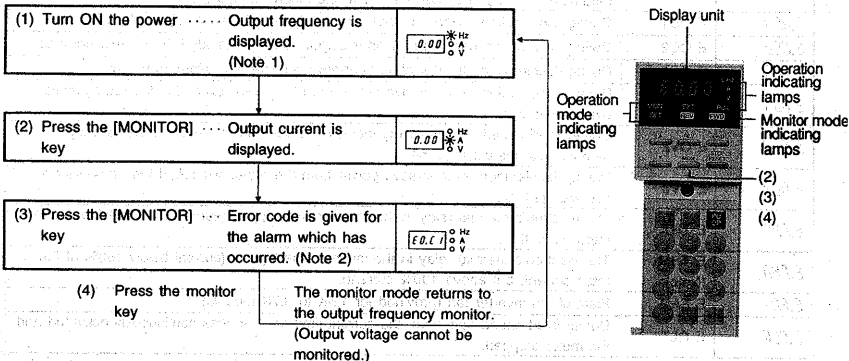

**Notes 1:** When the [WRITE] key is pressed while the parameter unit is displaying any of the above indicated monitor data, the priority is given to that monitor mode. After the setting of the priority, the selected information is displayed first when the parameter unit mode is changed to the monitor mode or just after the power is turned ON.

**2:** If a fault occurs within the inverter, the error message is given immediately. For the procedure used for checking the contents of the alarm, refer to page 103.

### (2) Other monitor

Monitor type	Display	Description
Rotation speed (m/min)	Display unit and monitor mode lamp	The information is displayed when Pr.37 is set. (Refer to page 73.)
Motor rotating direction (forward, reverse)	Forward, reverse indicating lamps	The forward or reverse indicating lamp blinks on and off.
During operation		The indicating lamp blinks on and off while the inverter is operating. The indicating lamp is off while the inverter is stopped. (Note 3)
External/PU operation mode	Mode indicating lamp	The external or PU operation mode indicating lamp is lit.
Monitor mode		The monitor mode indicating lamp is lit.
Setting mode		The setting mode indicating lamp is lit.
Jog mode	Display unit	"JOG" is displayed when the jog mode is selected.

**Note 3:** When the forward or reverse key is pressed in the PU operation mode or when the forward or reverse switch is turned ON in the external operation mode, the parameter unit recognizes this as "in-operation" and the indicating lamp blinks.

● If the stall prevention function is activated while in the monitor mode, the monitor mode indicating lamps (Hz, A, V) blink.

## 15. ERRORS

If a failure occurs within the inverter during operation, the corresponding error code is automatically displayed in the parameter unit.

### 15.1 Error Codes and Contents of Errors

Display	Error code	Contents of error
E. 0	E 0	Normal*
Err.	ERR	Setting operation error, reset signal is ON, incorrect connection between the parameter unit and the inverter, etc. wrong incoming voltage.
E.OC1	E OC1	During acceleration, inverter output current exceeded the overcurrent limit.
E.OC2	E OC2	During fixed speed operation, inverter output current exceeded the overcurrent limit.
E.OC3	E OC3	During deceleration, inverter output current exceeded the overcurrent limit.
E.Ov1	E OV1	During acceleration, regenerative power from the motor exceeded the regenerative overvoltage limit.
E.Ov2	E OV2	During fixed speed operation, regenerative power from the motor exceeded the regenerative overvoltage limit.
E.Ov3	E OV3	During deceleration, regenerative power from the motor exceeded the regenerative overvoltage limit.
E.SHT	E THT	The electronic thermal relay in the inverter was tripped (current over 150% of the rated current).
E.SHT	E THM (Note)	The electronic thermal relay in the inverter was tripped (current below 150% of the rated current, but above 100% current).
E.FRn	E FAN	Fault of the inverter fan (provided for 1.5K to 3.7K models)
E.OLT	E OLT	During fixed speed operation, the current limit function was continuously activated and the motor stopped.
E.be	E BE	Fault of the brake transistor in the inverter was detected.
E.OHT	E OHT	An external relay was tripped, which was connect to drive by customer.
E. PE	E PE	Fault of the memory device in the inverter where the parameter data is stored CPU defective.
E.PUE	E PUE	The parameter unit was disconnected from the inverter.
E.RET	E RET	Restarting was not possible within the set number of retries.
E.CPU	E CPU	Run-away of the CPU.
E. GF	E GF	If a ground fault current has flown due to a ground fault occurring in the output (load) side of the inverter, this function stops the inverter output. A ground fault occurring at low ground resistance may activate the overcurrent protection (OC1 to OC3). Provided for the 400V class only.
E.DPT	E OPT	The number of retries has been exceeded during computer communication.**

**Note:** The ETHM error occurs if current 150% of the current set for the electronic thermal relay (Pr.9) flowed the motor over an extended period of time.

#### Example

- If "5A" is set for Pr.9 (electronic thermal relay).

$$5(A) \times 150(\%) = 7.5(\%)$$

The protective function is activated by a current below 7.5A, due to the  $i^2t$  (the inverse time trip) characteristic of the built-in electronic thermal relay circuit.

- (\*) This error is displayed in the emergency stop status established by selecting the PU STOP key function in external operation is stopped by pressing this stop key during external operation and pressing the stop key.

- (\*\*) When using the option FR-CU03, this error will display on the following condition: during error from exceeded retries during communication, exceeded interval of communication time; retry execution during normal operation.

## 15. ERRORS

### • Other display

Display	Error code	Contents of error
<i>E.OPT</i>	E OPT	When the retry function is selected, retry is executed if the corresponding inverter alarm occurs. This message is displayed while retry is executed. The display is given for the period set by Pr.68 (retry execution waiting time).

### 15.2 Digital Display (7-Segment Display) and Actual Characters

The indication given by the 7-segment display represents the actual characters as shown below.

Actual character	Display	Actual character	Display	Actual character	Display
0	0	A	A	M	M
1	1	B	b	N	n
2	2	C	C	O	O
3	3	E	E	P	P
4	4	F	F	T	T
5	5	G	G	U	U
6	6	H	H	V	V
7	7	I	I	r	r
8	8	J	J	-	-
9	9	L	L		

# 15. ERRORS

## 15.3 Logged Error Contents

The contents of the errors are stored for the past four events. To check the contents of these stored errors, follow the procedure indicated below.

### • Operating procedure

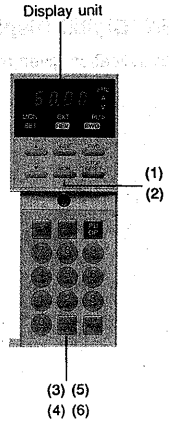
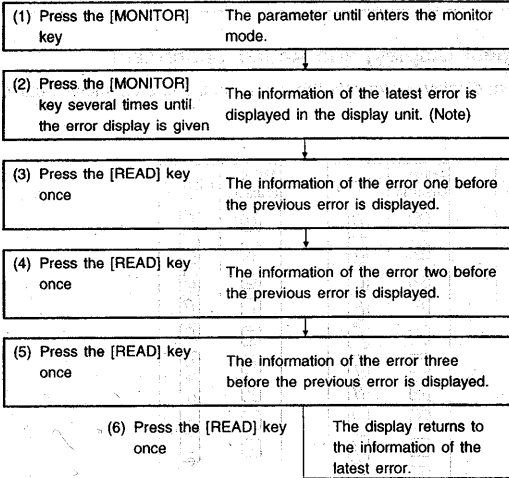

**Note:** For the information of the latest error, a period is displayed following "E". (Example: E.OC1)



## 15. ERRORS

### 15.4 Clearing Error Log

The log of errors (four events) can be cleared by the following operation.

#### • Operating procedure

(1) Press the [PU OP] key ... The PU operation indicating lamp is lit.	PU * operation
(2) Press the [SET] key ... "P." appears in the display unit.	P.
(3) Input "996" using the numeric keys ... "P.996" appears in the display unit.	P.996
(4) Press the [READ] key ... "Er.CL" appears in the display unit. (Note 1)	Er.CL
(5) Press the [WRITE] key ... "Er.CL" in the display unit blinks. This completes error log clear operation. (Note 2)	Er.CL (blinking)

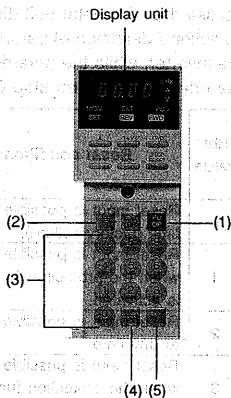

- Notes:**
1. If the [WRITE] key is pressed before pressing the [READ] key, the operation is not accepted.
  2. If the attempted error history clear operation is rejected by the inverter, "Err." and "Er.CL" are displayed alternately.

#### • To check the operation status just before the occurrence of an error:

If an error occurs, the contents of the display unit automatically switches to the display of the actuated protective function. If the monitor key is pressed without resetting (page 48) the inverter, the display unit displays output frequency. The frequency displayed will be that at which the motor was running just before the occurrence of the error. Current value can be checked in the same manner. However, these values are not stored 4 fault memory and are cleared by the reset operation.

## 16. PARAMETER UNIT DISCONNECTION DETECTION FUNCTION

This function detects disconnection of the parameter unit from the inverter and stops the inverter operation (inverter error).

### ● Operation of the function

To use the parameter unit disconnection detection function, set the proper value for Pr.75 (reset selection / detection of parameter unit disconnection). If the parameter unit is disconnected from the inverter, while the parameter unit disconnection detection function is valid, it is detected and the drive stops (alarm stop due to inverter error).

Set value	Reset conditions	External terminals	Key operation (Parameter unit)	Operation after disconnection of parameter unit	PU STOP key
0	Reset input is possible at any time (factory-setting).	○	x*	Operation will be continued with the PU disconnected.	No function
1	Reset input is possible only when the protection function is activated.	○	○		
2	Reset input is possible at any time.	○	x*	When the parameter unit is disconnected, the ALARM LED is lit and inverter output is shut off.	
3	Reset input is possible only when the protection function is activated.	○	○		
14	Reset input is possible at any time (factory-setting).	○	x*	Operation will be continued with the PU disconnected.	When stop key on PU is pressed in any operation mode, motor stops.
15	Reset input is possible only when the protection function is activated.	○	○		
16	Reset input is possible at any time.	○	x*	When the parameter unit is disconnected, the ALARM LED is lit and inverter output is shut off.	
17	Reset input is possible only when the protection function is activated.	○	○		

When reset is carried out using external terminal or PU key.

○: Yes, x: No

**Notes** 1: The stop key function is not activated with set values 0 to 3; it is actuated with set values 14 to 17 (Refer to page 84).

2: The error display at an occurrence of PU disconnection alarm stop is "E.PUE".

\* When parameter unit model FR-PU02E-1 is used, reset is possible by inverter reset operation in the help mode.

## 16. PARAMETER UNIT DISCONNECTION DETECTION FUNCTION

---

● **Cautions on setting the parameter unit disconnection detection function:**

- (1) If the parameter unit is not connected at the start of operation, an alarm does not occur.
- (2) This function recognizes "disconnection" when the parameter unit is disconnected for more than 1 second.
- (3) To restart the inverter operation after the occurrence of the disconnection alarm, confirm the connection of the parameter unit and reset the inverter. (refer to page 48)
- (4) If the inverter is operated without selecting the parameter unit disconnection detection function, inverter operation is continued even after the parameter unit is disconnected from the inverter, which will create a hazardous situation. Therefore, to ensure safe operation, it is recommended that the parameter unit disconnection detection function be selected.

## 17. RESETTING THE INVERTER

To reset the inverter, follow any of the following four procedures. Remember that the accumulated internal thermal data of the electronic thermal relay and the retry count are cleared if the inverter is reset.

### ● Operation 1

(1) Press the [PU OP] key ··· The PU operation indicating lamp is lit.	PU * operation
(2) Press the [SET] key ····· "P." appears in the display unit.	P.
(3) Input "997" using ······ "P.997" appears in the display unit.	P.997
(4) Press the [READ] key ··· "rEST" appears in the display unit. (Note 1)	rEST
(5) Press the [WRITE] key ··· "rEST" in the display unit is turned off. This completes inverter reset operation. (Note 2)	rEST (off)

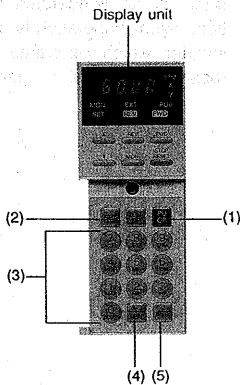

- Notes** 1: If the [WRITE] key is pressed before pressing the [READ] key, it is not accepted.  
 2: If the attempted inverter reset clear operation is rejected by the inverter, "Err." and "rEST" are displayed alternately.

### ● Operation 2

Press the [STOP] key while the inverter is in faulty state.

### ● Operation 4

Close the circuit across the reset terminal RES and SD for more than 0.1 second and then open it.

### ● Operation 3

Turn OFF power supply once. After making sure that the POWER indicating lamp or the LED has gone out, turn on power supply again.

## 18. CALIBRATING THE FREQUENCY METER

The frequency meter of the inverter or the one connected to the terminals FM and SD can be calibrated by using the parameter unit.

If a digital frequency meter is used, you may want to adjust the frequency of pulse-train output.

### • Preparation

- (1) Connect the frequency meter to the terminals FM and SD of the inverter. Make sure that the polarity is correct.
- (2) If a variable resistor used for calibration is connected, either adjust it to zero or remove it.

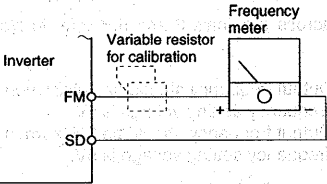

**Note:** If the signal output from the terminal FM is to corresponding to the motor current value, connect a variable resistor for calibration at the position shown in the illustration in the left.

### • Calibration procedure (Adjust while operating the inverter)

(1) Operate the inverter at the maximum output frequency (60Hz, for example) using the parameter unit.	60.00
(2) Press the [PU OP] key ... The PU RUN indicating lamp is lit.	PU operation *
(3) Press the [SET] key ... "P." appears in the display unit.	P.
(4) Input "900" using the numeric keys	P.900
(5) Press the [READ] key ... The maximum frequency is displayed in the display unit.	60.00
(6) Adjust the meter indication	Move the pointer of the frequency meter by pressing the [▲] (or [▼]) key while observing the pointer.
(7) Press the [WRITE] key ... Calibration is completed.	60.00 ↑ Displayed ↓ alternately P.900

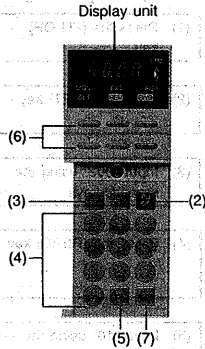

**Notes 1:** For this operation, it is not necessary to connect a motor.

**2:** Select the PU operation mode to carry out calibration. Never calibrate the frequency meter in the external operation mode.

## 19. ADJUSTING "BIAS" AND "GAIN" OF FREQUENCY SETTING SIGNALS

To control the output frequency of the inverter, external reference signals are input either in voltage (0 to 5 VDC, 0 to 10 VDC) or current (4 to 20mA DC). "Bias" and "Gain" are used to adjust the relationship between the external reference signal and the frequency to be output.

Bias and gain are set using the following parameters.

- Pr.902 Frequency setting voltage bias
- Pr.903 Frequency setting voltage gain
- Pr.904 Frequency setting current bias
- Pr.905 Frequency setting current gain

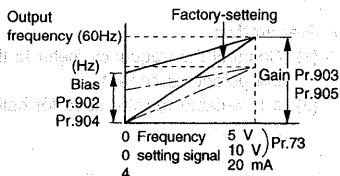

Adjust the gain and bias by applying proper voltage across terminals 2 and 5. (Refer to Note.)

### ● Adjusting Procedure

( Example: Pr.902 (frequency setting voltage bias) ... Output frequency should be 10Hz when frequency setting voltage is 0V.  
 Pr.903 (frequency setting voltage gain) ... Output frequency should be 50Hz when frequency setting voltage is 5V.

Before beginning adjustment, make sure that the setting for Pr.73 (0 to 5V / 0 to 10V selection) is "0" (factory setting ... 0 to 5V).

(1) Press the [PU OP] key	The PU operation indicating lamp is lit.	PU operation *
(2) Press the [SET] key	"P." appears in the display unit.	P.
(3) Input "902" using the numeric keys.	"P.902" appears in the display unit.	P.902
(4) Press the [READ] key	The current setting is displayed in the display unit.	0.00
(5) Input "10" using the numeric keys. Apply a 0 V voltage value.	"10" appears in the display unit.	10
(6) Press the [WRITE] key	The newly set value is stored to the memory.	10.00 ↓ Displayed alternately P.902
(7) Press the [READ] key (The next parameter is displayed)	"P.903" appears in the display unit.	P.903

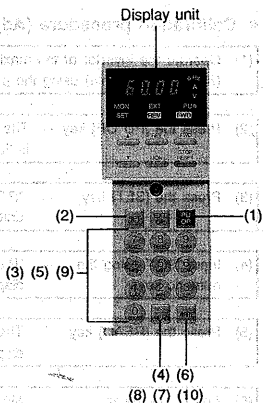

## 19. ADJUSTING "BIAS" AND "GAIN" OF FREQUENCY SETTING SIGNALS

(8) Press the [READ] key ... The current setting is displayed in the display unit.	60.00
(9) Input "50" using the numeric keys. Apply a 5 V voltage value. "50" appears in the display unit.	50
(10) Press the [WRITE] key ... The newly set value is stored to the memory.	50.00 ↓ Displayed alternately P.902

\* If input voltage difference for bias and gain is less than 5%, drive will not accept the values.

**Note:** Adjust bias and gain by applying 5V (10V) across terminals 2 and 5 (frequency setting input terminals).

While voltage is applied across these terminals, frequency is output corresponding to the input voltage. For example, if the bias and gain are set as explained, output frequency is obtained as shown by the graph (solid line) below if 1V is applied across terminals 2 and 5. When current input is used to control the output frequency, a similar setting should be made using Pr.904 and Pr.905.

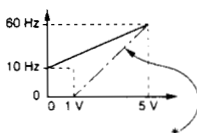

\* To adjust output frequency to 0Hz in response the input of 1V, change the bias using the same procedure.

## **20. CONTROLLING KEY CLICK SOUND (TACTILE FEED BACK)**

With the model FR-PU03 parameter unit, a key click sound can be added to confirm complete execution of key stroke. To output key click sound, follow the procedure below.

Pr.990 is factory set to 0 for no key click sound.

- To change the setting to "with key click sound", set "1" in Pr.990.

**Note:** To set "no key click sound" again, set Pr. 990 to "0" (factory- setting).



## 21. SELECTING GENERAL-PURPOSE MAGNETIC FLUX VECTOR CONTROL

The general-purpose magnetic flux vector control can be selected by setting the motor capacity and type of motor.

The general-purpose magnetic flux vector control is effective for applications where greater starting torque or more than V/F mode torque at low speed is required, or the load is varying.

(1) Conditions for selecting the general-purpose magnetic flux vector control

The general-purpose magnetic flux vector control can be effectively used only when the following conditions are satisfied. If the general-purpose magnetic flux vector control is selected while any of these conditions is not satisfied, it will cause insufficient torque, irregular rotation, and other problems. In which case, V/F control should be selected.

Conditions

- The motor capacity is either equivalent to or one rank below the inverter capacity.
- The motor type is Mitsubishi standard motor (0.1kW (1/8HP) or larger, 200V class; 0.2kW (1/4HP) or larger 400V class), Mitsubishi constant torque motor (SF-JRC, 200V class, 4 poles, 0.4 (1/2HP) to 3.7kW (5HP)) or MITSUBISHI equivalent.
- The number of poles is 2, 4, or 6. (It is not necessary to set the number of poles. For constant torque motors, 4 poles only)
- The motor is controlled by its own inverter.
- Wiring distance between the motor and the inverter is within 30m (98.46 feet). If the distance exceeds 30m (98.46 feet), refer to MITSUBISHI.

(2) Selecting the general-purpose magnetic flux vector control ... Set the motor capacity (other than "9999"; "9999" calls for the V/F control.) for Pr.80 (motor capacity). If a Mitsubishi constant torque motor is used, set "1" for Pr.71 (applicable motor).

**Note: Cautions on general-purpose magnetic flux vector control**

- (1) Irregular rotation of the motor will be a little more apparent than in the V/F control.
- (2) At the start, 0.1 to 0.2 second delay is generated due to control data calculation.
- (3) If this control is selected, the following parameter settings will be ignored. (Pr.0, Pr.3, Pr.14, Pr.19, Pr.46, Pr.47)

Applications for which the general-purpose magnetic flux vector control is recommended

- The machine which requires greater starting torque
- The machine in which torque variation is excessive
- The machine which requires more than V/F mode torque at low-speed.

(This control is not recommended for machines, such as grinders and lapping machines, which requires low irregularity at speed control at low-speed operation.)

## 21. SELECTING GENERAL-PURPOSE MAGNETIC FLUX VECTOR CONTROL

(3) Parameters related to the general-purpose magnetic flux vector control

Parameter No.	Name	Setting range	Set value	Description	Factory-setting
80	Motor capacity	0.1 (1/8HP) to 3.7KW (5HP), 9999*2	9999	Selection of V/F control	○
			0.1 to 3.7*2	Setting of motor capacity (kW) (Selection of general-purpose magnetic flux vector control)	-
71	Applicable motors*1	0.1	0	Standard motor (NEMA B TEFC or ODP)	○
			1	Constant torque motor (separately cooled)	-

\*1. The electronic thermal relay characteristics are selected.

\*2. A 0.1 kW setting cannot be made for the 400 V class.

■ **Setting methods for when general-purpose flux vector control is selected and wiring distance between inverter and motor exceeds 30 m**

### 1. Setting procedure

(1) Calculate the setting values of the special parameter.

Calculate the setting value as shown below.

• **Wiring resistance value (resistance (Ω) per 1 m of wiring length (m))** (A calculation example is shown below.)

#### <Reference values>

Wire size (mm <sup>2</sup> )	Resistance value for 1 m
0.75	0.02195 Ω
1.25	0.01299 Ω
2	0.008573 Ω
3.5	0.004926 Ω

(For special wire sizes, the following equation is used.)

$$R (\Omega) = \rho \times \frac{l}{A}$$

$\rho$ : constant  $1.7241 \times 10^{-2}$

A: cross-section area

l: length

(2) Special parameter setting method

Set the value obtained in section (1) above with the following procedure.

- ① Pr. 77: Set to 801 (Note 2)
- ② Pr. 80: Set motor capacity
- ③ Pr. 87: Set resistance value
- ④ Pr. 77: Set to 0 or 1 (Return to original setting value)

No.	Name	Setting range	Min. value	Factory setting value
87	Wiring resistance	0 ~ 50Ω	0.001Ω	0

**Note:** Pr. 87 is displayed only when Pr. 77 is set to 801.

(Note 1) The torque may not be achieved if not set.

(Note 2) When Pr. 77 is set to 801, the parameters following Pr. 82 will display simultaneously, but do not change the other parameters. The inverter could be damaged if the parameters are changed.

### Setting value calculation examples

Wire size (mm <sup>2</sup> )	Wiring length						
	20m (65.64 feet)	30m (98.46 feet)	50m (164.04 feet)	80m (262.46 feet)	100m (328.08 feet)	150m (492.12 feet)	200m (656.16 feet)
2	0.171Ω	0.257Ω	0.429Ω	0.686Ω	0.857Ω	1.286Ω	1.715Ω
3.5	0.099Ω	0.148Ω	0.246Ω	0.394Ω	0.493Ω	0.739Ω	0.985Ω
5.5	0.065Ω	0.097Ω	0.162Ω	0.260Ω	0.325Ω	0.487Ω	0.650Ω

## 21. SELECTING GENERAL-PURPOSE MAGNETIC FLUX VECTOR CONTROL

### ■ Setting method when wiring distance is particularly long

#### 1. Setting procedure

- (1) If the maximum wiring distance is longer than the values given in the following table, set parameter 98 to invalidate the current limits.

(The factory setting is "0", but setting this to "8" is recommended.)

Inverter Capacity	0.1k	0.2k	0.4k	0.75k	1.5k	2.2k	3.7k
No Low-Noise Operation	200m (656.4 feet)	200m (656.4 feet)	300m (984.6 feet)	500m (1641 feet)	500m (1641 feet)	500m (1641 feet)	500m (1641 feet)
Low-Noise Operation	30m (98.46 feet)	100m (328.2 feet)	200m (656.4 feet)	300m (984.6 feet)	500m (1641 feet)	500m (1641 feet)	500m (1641 feet)

Pr. 98 setting	Details	Pr. 98 setting	Details
0	Current limit, with stall prevention	★8	No current limit, with stall prevention
1	Current limit during acceleration, no stall prevention	9	No current limit, no stall prevention during acceleration
2	Current limit during constant speed, no stall prevention	10	No current limit, no stall prevention during constant speed
3	Current limit during acceleration/constant speed, no stall prevention	11	No current limit, no stall prevention during acceleration/constant speed
4	Current limit during deceleration, no stall prevention	12	No current limit, no stall prevention during deceleration
5	Current limit during acceleration/deceleration, no stall prevention	13	No current limit, no stall prevention during acceleration/deceleration
6	Current limit during constant speed/deceleration, no stall prevention	14	No current limit, no stall prevention during constant speed/deceleration
7	No current limit, no stall prevention	15	No current limit, no stall prevention

## 21. SELECTING GENERAL-PURPOSE MAGNETIC FLUX VECTOR CONTROL

### (2) Special parameter setting procedure

Set the setting value in (1) above with the following procedure.

- ① Pr. 77: Set to 801 (Note 1)
- ② Pr. 98: Set the setting value
- ③ Pr. 77: Set to 0 or 1 (Return to original setting value)

No.	Name	Setting range	Min. value	Factory setting
98	Current limit, stall prevention function selection	0 - 15	1	0

\*: Pr. 98 is displayed only when Pr. 77 is set to 801.

**(Note 1)** When Pr. 77 is set to 801, the parameters following Pr. 82 will display simultaneously, but do not change the other parameters. The inverter could be damaged if the parameters are changed.

## 22. PARAMETERS

### Parameter List

Function	Parameter No.	Name	Setting Range	Minimum Setting	Factory-Setting	Customer's Setting	Refer to:
Basic Functions	0	Torque boost (manual)	0 to 30%	0.1%	6%		p.62
	1	Upper limit frequency	0 to 120Hz	0.01Hz (Note 6)	120Hz		
	2	Lower limit frequency	0 to 120Hz	0.01Hz (Note 6)	0Hz		
	3	Base frequency	0 to 400Hz	0.01Hz (Note 6)	60Hz		p.63
	4	3-speed setting (high speed)	0 to 400Hz	0.01Hz (Note 6)	60Hz		p.64
	5	3-speed setting (middle speed)	0 to 400Hz	0.01Hz (Note 6)	30Hz		
	6	3-speed setting (low speed)	0 to 400Hz	0.01Hz (Note 6)	10Hz		
	7	Acceleration time	0 to 3600sec.	0.1sec.	5sec.		p.65
	8	Deceleration time	0 to 3600sec.	0.1sec.	5sec.		
9	Electronic thermal overload relay	0 to 500A	0.01A	Rated output current (Note 1)			
Standard Operation Functions	10	DC injection braking frequency	0 to 120Hz	0.01Hz (Note 6)	3Hz		p.66
	11	DC injection braking time	0 to 10sec.	0.1sec.	0.5sec.		
	12	DC injection braking voltage	0 to 30%	0.1%	6%		
	13	Starting frequency	0 to 60Hz	0.01Hz (Note 6)	0.5Hz		p.67
	14	Selection of applied load	0, 1, 2, 3	1	0		
	15	Jog frequency	0 to 400Hz	0.01Hz (Note 6)	5Hz		
	16	Jog acceleration/deceleration time	0 to 3600sec.	0.1sec.	0.5sec.		p.68
	17	External thermal relay input	0, 1	1	0		
	18	Upper limit frequency for high speed operation	120 to 400Hz	0.1Hz	120Hz		
	19	Base frequency voltage	0 to 1000V, 9999	0.1V	9999		p.69
	20	Reference frequency for acceleration/deceleration	1 to 400Hz	0.01Hz (Note 6)	60Hz		
	22*	Stall prevention function operation level	0 to 200%	0.1%	150%		
	23	Stall prevention function operation level offset coefficient for doublespeed operation	0 to 200%, 9999	0.1%	9999		

## 22. PARAMETERS

### ■ Parameter List

Function	Parameter No.	Name	Setting Range	Minimum Setting	Factory-Setting	Customer Setting	Refer to:
Standard Operation Functions	24	Multiple-speed setting (speed 4)	0 to 400Hz, 9999	0.01Hz (Note 6)	9999		p.69
	25	Multiple-speed setting (speed 5)	0 to 400Hz, 9999	0.01Hz (Note 6)	9999		
	26	Multiple-speed setting (speed 6)	0 to 400Hz, 9999	0.01Hz (Note 6)	9999		
	27	Multiple-speed setting (speed 7)	0 to 400Hz, 9999	0.01Hz (Note 6)	9999		
	29**	Selection of acceleration/deceleration pattern	0, 1, 2	1	0		p.70
	30	Selection of regenerative brake duty ratio	0, 1	1	0		p.71
	31	Computer link E <sup>2</sup> ROM write validity	0, 1, 9999	1	0		p.72
	32	Communication speed	12, 24, 48, 96, 9999	1	96		
	33	Operation command selection	0, 1, 9999	1	0		
	34	Speed command selection	0, 1, 9999	1	0		
	35	Start-up operation mode	0, 1, 9999	1	0		
	36	Station number selection	0 to 31, 9999	1	0		
	p.73	37	Speed display	0, 0.01 to 9998	0.001	0	
38		Frequency at 5V (10V) input	1 to 400Hz	0.01Hz (Note 6)	60Hz		
39		Frequency at 20mA input	1 to 400Hz	0.01Hz (Note 6)	60Hz		
Function for Multi-Function Output Terminals	40	Allocation of output terminals	00 to 44	1	2		p.74
	41	Adjusting the SU frequency band width	0 to 100%	0.1%	10%		p.75
	42	FU frequency value	0 to 400Hz	0.01Hz (Note 6)	6Hz		
	43	FU frequency value in reverse rotation	0 to 400Hz, 9999	0.01Hz (Note 6)	9999		
Second Functions	44	2nd acceleration/deceleration time	0 to 3600sec., 9999	0.1 sec.	9999		p.76
	45	2nd deceleration time	0 to 3600sec., 9999	0.1sec.	9999		

## 22. PARAMETERS

### Parameter List

Function	Parameter No.	Name	Setting Range	Minimum Setting	Factory-Setting	Customer's Setting	Refer to:
Second Functions	46	2nd torque boost	0 to 30%, 9999	0.1%	9999		p.76
	47	2nd V/F (base frequency)	0 to 400Hz, 9999	0.01Hz (Note 6)	9999		
Computer Communication Functions	48	Data length	0, 1, 9999	1	0		
	49	Stop bit length	0, 1, 9999	1	1		
	50	Parity check	0, 1, 2, 9999	1	2		
	51	CR, LF code selection	0, 1, 2, 9999	1	1		
	52	Number of communication retries	0 to 10, 9999	1	1		
	53	Communication check time interval	0, 0.1 to 999.8, 9999	0.1sec	0		
Display Functions	54	Selection of FM terminal function	0, 1	1	0		p.77
	55	Reference for frequency monitor (FM)	0 to 400Hz	0.01Hz (Note 6)	60Hz		
	56	Reference for current monitor (FM)	0 to 500A	0.01A	Rated output current		
Restart Functions	57	Free-wheeling time for restart	0, 0.1 to 5sec., 9999	0.1sec.	9999		p.78
	58	Start-up time for restart	0 to 5sec.	0.1sec.	0.5sec.		
Operation Selection Functions	59	Input terminal allocation	0 to 9998, 9999	1	9999		p.80
	60	Input filter time constant	1 to 8, 9999	1	9999		
	61	Tone control selection	0, 1	1	0		
	62	Open motor circuit detection level	0 to 200%, 9999	0.1%	5.0%		
	63	Open motor circuit detection time	0.05 to 1sec., 9999	0.01sec.	0.5sec.		
	64	Constant output range slip compensation selection	0, 9999	-	9999		p.81
	65	Retry selection	0, 1, 2, 3	1	0		p.82
	66	Frequency for stall prevention function level reduction start frequency	0 to 400Hz	0.01Hz (Note 6)	60Hz		
	67	Retry count after an occurrence of inverter alarm	0 to 10, 101 to 110	1	0		
	68	Retry waiting time	0.1 to 360sec.	0.1sec.	1 sec.		
69	Clearing retry count	0	-	0			
	70	Special regenerative brake duty ratio	0 to 30% (Note 2)	0.1%	0%		p.83

## 22. PARAMETERS

### ■ Parameter List

Function	Parameter No.	Name	Setting Range	Minimum Setting	Factory-Setting	Customer's Setting	Refer to:
Operation Selection Functions	71*	Applicable motor selection	0, 1	1	0		p.83
	72	Selection for PWM frequency	0.7 to 14.5kHz (Note 3)	0.1kHz	1kHz		
	73	Selection for 0 to 5V/0 to 10V	0, 1	1	0		p.84
	74	Selection for current input reference/ starting command, rotation direction command selection	0, 1, 100, 101	1	0		
	75	Reset selection/ detection of parameter unit disconnection	0 to 3, 14 to 17	1	14		
	76	Slip compensation time constant	0.01 to 10sec., 9999	0.01sec.	0.5sec.		p.86
	77	Selection for disabling parameter writing	0, 1, 2	1	0		
	78	Selection of reverse rotation prevention	0, 1, 2	1	0		
	79*	Selection of operation mode	0 to 4, 6 to 8	1	0		p.89
	80*	Motor capacity	0.1 to 3.7kW, 9999 (Note 4)	0.01kW	9999		
Standard Operation Functions	81	Rated slip	0 to 10%, 9999	0.01%	9999		p.90
	91	Frequency jump 1A	0 to 400Hz, 9999	0.01Hz (Note 6)	9999		
	92	Frequency jump 1B	0 to 400Hz, 9999	0.01Hz (Note 6)	9999		
	93	Frequency jump 2A	0 to 400Hz, 9999	0.01Hz (Note 6)	9999		
	94	Frequency jump 2B	0 to 400Hz, 9999	0.01Hz (Note 6)	9999		
	95	Frequency jump 3A	0 to 400Hz, 9999	0.01Hz (Note 6)	9999		
	96	Frequency jump 3B	0 to 400Hz, 9999	0.01Hz (Note 6)	9999		
	126	Multi-speed (speed 8)	0 to 400Hz, 9999	0.01Hz (Note 6)	9999		
	127	Multi-speed (speed 9)	0 to 400Hz, 9999	0.01Hz (Note 6)	9999		
	128	Multi-speed (speed 10)	0 to 400Hz, 9999	0.01Hz (Note 6)	9999		
	129	Multi-speed (speed 11)	0 to 400Hz, 9999	0.01Hz (Note 6)	9999		
	130	Multi-speed (speed 12)	0 to 400Hz, 9999	0.01Hz (Note 6)	9999		



## 22. PARAMETERS

### Parameter List

Function	Parameter No.	Name	Setting Range	Minimum Setting	Factory-setting	Customer's setting	Refer to:
Standard Operation Functions	131	Multi-speed (speed 13)	0 to 400Hz, 9999	0.01Hz (Note 6)	9999		p.90
	132	Multi-speed (speed 14)	0 to 400Hz, 9999	0.01Hz (Note 6)	9999		
	133	Multi-speed (speed 15)	0 to 400Hz, 9999	0.01Hz (Note 6)	9999		
Calibration Functions	900	FM terminals calibration	-	-	-		p.91
	902	Bias for frequency setting voltage	0 to 10V	0 to 60Hz	0.01Hz	(0V) 0Hz	p.92
	903	Gain for frequency setting voltage	0 to 10V	1 to 400Hz	0.01Hz	(5V) 60Hz	
	904	Bias for frequency setting current	0 to 20mA	0 to 60Hz	0.01Hz	(4mA) 0Hz	
	905	Gain for frequency setting current	0 to 20mA	1 to 400Hz	0.01Hz	(20mA) 60Hz	
990	Selection for key click sound	0, 1	1	0		p.93	
991	Selection of the parameter unit display data	0, 1, 2	1	0			
996	Alarm clear	-	-	-			
997	Inverter reset	-	-	-			
998*	Parameter all clear	-	-	-			
Miscellaneous Functions	999*	Parameter clear	-	-	-		p.94

- Notes**
- For 0.1 K to 0.75 K models, setting is "85%" of the rated current of the inverter.
  - The duty ratio indicates the "%ED" of the operation of the built-in brake transistor.
  - During the operation of the inverter, the change or writing of the set values is restricted to either of the following ranges.
 

(1) 0.7 kHz to 1.1 kHz	The change or writing of the set values beyond the individual ranges is not permitted.
(2) 1.2 kHz to 14.5 kHz	
  - 0.2 to 3.7 kW for the 400V type
  - The unit has been calibrated before shipment, so the setting value will differ slightly for each inverter. Set so that the frequency is slightly higher than 60 Hz.
  - If the setting value is 100 Hz or higher, the setting unit will be 0.1 Hz.
  - The setting values of parameters marked with \* can be changed during operation even if Pr. 77 is set to 2 (writing during operation enabled). Even if the parameters marked with \*\* are written during operation, they will be validated after the inverter is stopped.

**Note:** Parameters in    can be changed or written while the inverter is operating even if the setting for Pr.77 (Selection for disabling parameter writing) is "0" (factory-setting). Note that modification of Pr.72, Pr.77, and Pr.900 is allowed only in the PU operation mode.

### ■ Description of the Parameters

"Pr." in an abbreviation of "Parameter."

#### Pr.0 Setting the torque boost (manual)

- It is possible to adjust the motor torque in the low frequency range meeting the load.

**Notes**

- 1: Factory-setting ... 6%
- 2: Change the setting to "4%" for motors designed for use with an inverter (constant torque motor).
- 3: The setting for this parameter is ignored if the general-purpose magnetic flux vector control mode is selected with Pr.80.

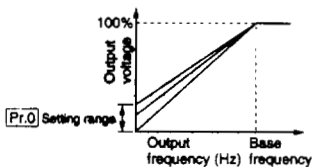

#### Pr.1 Pr.2 Setting the upper/lower limit of frequency

Pr.1 Upper limit frequency

Pr.2 Lower limit frequency

- It is possible to clamp the upper and lower limits of output frequency.

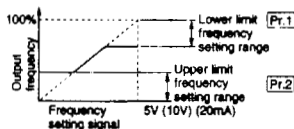

**Note:** To set the frequency higher than 120Hz, use Pr.18.

### ⚠ CAUTION

⚠ Note that without the speed command, the motor will start at the preset frequency by merely switching on the start signal.

If set value of Pr.2 "Lower limit frequency" is equal or larger than the value of Pr.13 "Starting frequency".

## Pr.3 Setting the base frequency

Pr.3 Base frequency

Pr.19 Base frequency voltage

- It is possible to set the base frequency (reference frequency corresponding to the motor rated torque) meeting the motor rating, in the range of 0 to 400Hz.
- By setting proper the value for Pr.19 (base frequency voltage), the PWM output is modified so that the waveform looks to the motor like the voltage value set in parameter 19. This will result in optimum motor performance.

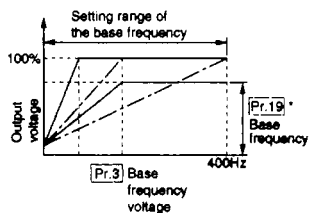

\*: If "9999" (factory-setting) is set for Pr.19, the maximum output voltage is the same as the power supply voltage.

**Note:** If the general purpose magnetic flux vector control mode has been selected with Pr.80, setting of Pr.3 becomes 60Hz.

If Pr.19 has been set at "9999", Pr.19 = 220V (440V for the 400V type) will become valid.

When using the motor designed for use with an inverter (constant torque motor), set 60Hz for the base frequency.

Pr.4	Pr.5	Pr.6	Setting the multiple-speed				
Pr.4	3-speed setting (high speed)	Pr.24	Multiple-speed setting (speed 4)	Pr.126	Multiple-speed setting (speed 8)	Pr.130	Multiple-speed setting (speed 12)
Pr.5	3-speed setting (middle speed)	Pr.25	Multiple-speed setting (speed 5)	Pr.127	Multiple-speed setting (speed 9)	Pr.131	Multiple-speed setting (speed 13)
Pr.6	3-speed setting (low speed)	Pr.26	Multiple-speed setting (speed 6)	Pr.128	Multiple-speed setting (speed 10)	Pr.132	Multiple-speed setting (speed 14)
		Pr.27	Multiple-speed setting (speed 7)	Pr.129	Multiple-speed setting (speed 11)	Pr.133	Multiple-speed setting (speed 15)

- It is possible to select the motor speed by simply changing the external contact signal across terminals RH/RM/RL/REX and SD.
- When using speeds 8 to 15, assign the RH, RM, RL and REX functions to the input terminals RL/OH, RM/AU, RH and MRS/RT with Pr. 59 "Input terminal allocation".
- The individual speeds (frequency) can be set as required, in the range of 0 to 400Hz, while the inverter is operating. Setting is also possible using the [▲] and [▼] keys.
- By combining the setting for these parameters with Pr.1 (upper limit frequency) and Pr.2 (lower limit frequency), setting of up to seventeen speeds is possible.

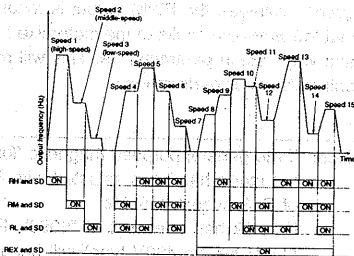

- Notes**
- If "9999" (factory-setting) is set for Pr.24 to Pr.27 and Pr.126 to Pr.133, speed 4 to speed 15 are not selected.
  - In the speed 3 setting, if more than two speeds are selected at the same time, the setting for lower speed parameter is output.  
 <Example> If RH and SD, RL and SD are turned ON at the same time while the setting for high-speed (RH) is 40 Hz and low-speed (RL) is 50 Hz, output frequency is 50Hz.
  - If the multiple-speed signal frequency setting signal are input, the multiple-speed operation is given priority.
  - The multiple-speed setting can be made during either PU operation or external operation.

RL	RM	RH	REX	speed
-	-	○	-	Pr.4
-	○	-	-	Pr.5
○	-	-	-	Pr.6
○	○	-	-	Pr.24 (when Pr.24 is 9999, speed 4 is not set)
○	-	○	-	Pr.25 (when Pr.25 is 9999, speed 5 is not set)
-	○	○	-	Pr.26 (when Pr.26 is 9999, speed 6 is not set)
○	○	○	-	Pr.27 (when Pr.27 is 9999, speed 7 is not set)
-	-	-	○	Pr.126 (when Pr.126 is 9999, speed 8 is not set)
-	-	○	○	Pr.127 (when Pr.127 is 9999, speed 9 is the same as Pr.4)
○	○	-	○	Pr.128 (when Pr.128 is 9999, speed 10 is the same as Pr.5)
○	-	-	○	Pr.129 (when Pr.129 is 9999, speed 11 is the same as Pr.6)
○	-	-	○	Pr.130 (when Pr.130 is 9999, speed 12 is the same as Pr.24)
○	-	-	○	Pr.131 (when Pr.131 is 9999, speed 13 is the same as Pr.25)
-	○	○	○	Pr.132 (when Pr.132 is 9999, speed 14 is the same as Pr.26)
○	○	○	○	Pr.133 (when Pr.133 is 9999, speed 15 is the same as Pr.27)

Pr.7	Pr.8	<b>Setting the acceleration/deceleration time</b>
Pr.7		Acceleration time
Pr.8		Deceleration time
Pr.20		Base frequency for acceleration/deceleration

- Acceleration time (Pr.7) indicates the time in which frequency, starting from 0Hz, reaches the reference frequency (Pr.20). Deceleration time (Pr.8) indicates the time in which frequency, starting from the setting for Pr.20, reaches 0Hz.
- If "0" is set for acceleration/deceleration time, it corresponds to 0.04 sec.

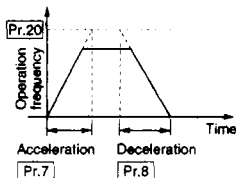

**Note:** When the acceleration pattern is S-pattern A (refer to Pr.29), the time indicates the period to reach to the base frequency (Pr.3).  
The output frequency corresponding to the frequency setting signal (analog) is set with the gain (Pr.903, Pr.905) (Refer to page 92.).

Pr.9	<b>Setting the electronic thermal relay</b>
------	---

- Set Pr.9 to the motor nameplate full load amps. The electronic compensation for reduced motor cooling at lower frequencies protection characteristics include.
- If "0" is set, the motor protection function is invalid. In this case, the protection function for the output transistor of the inverter is valid.
- If a blower cooled or TENV constant torque motor is used, set "1" in Pr.71 to select 100% continuous torque characteristics in the low-speed range. Then, set the rated current of the motor in Pr.9 (electronic thermal relay).
- Factory-setting is "rated output current of the inverter". For 0.1K to 0.75K models, setting is "85%" of the rated output current of the inverter.

Pr.10	Pr.11	Pr.12	Adjusting the DC injection braking
-------	-------	-------	------------------------------------

Pr.10	DC injection braking frequency
-------	--------------------------------

Pr.11	DC injection braking time
-------	---------------------------

Pr.12	DC injection braking voltage
-------	------------------------------

- It is possible to adjust the "positioning on stop" control by setting the DC injection braking voltage, braking time, and the frequency at which braking, applied.
- DC dynamic braking voltage (factory-setting) ... 6%

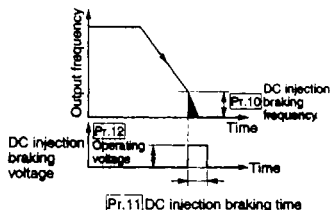

**Note:** When using an inverter duty motor (constant torque motor) change the setting to 4%.

**⚠ CAUTION**

⚠ Install a mechanical brake. There is no stopping torque.

Pr.13	Setting the starting frequency
-------	--------------------------------

- The starting frequency can be set in the range of 0 to 60Hz.

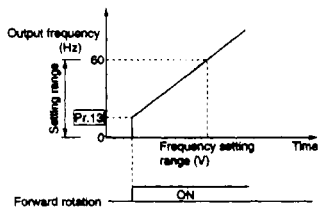

**Pr.14** **Selecting the applied load**

- It is possible to select the output characteristics (V/F characteristics) proper for the application and the load characteristics.

**Setting: 0** (factory-setting)

For constant torque load (conveyors, carts)

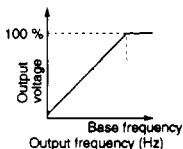
**Setting: 1**

For variable torque load (fans, pumps)

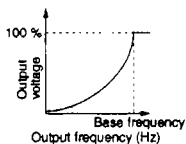
**Setting: 2**

For vertical loads

Boost for forward rotation ... Setting for Pr.0

Boost for reverse rotation ... 0%

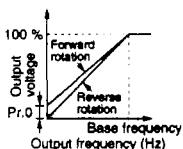
**Setting: 3**

For vertical loads

Boost for forward rotation ... 0%

Boost for reverse rotation ... Setting for Pr.0

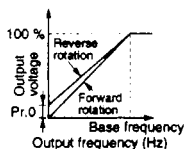

**Note:** If the general-purpose magnetic flux control mode is selected, the setting for this parameter is ignored.

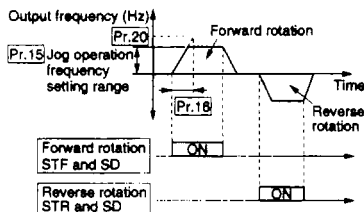
**Pr.15** **Pr.16** **Setting the jog operation****Pr.15** Jog frequency**Pr.16** Jog acceleration/deceleration time

- Jog operation is possible using the parameter unit.  
(Jog operation is not allowed when "3" or "4" is set for Pr.79.)
- In the external operation mode, jog operation is not allowed.

**Note:** If the parameter unit is disconnected from the inverter during jog operation, the inverter will decelerate to a stop.

**Pr.17** Setting the thermal relay input

- The function allocated to terminal RL/OH is switched according to the setting of "0" or "1" for Pr.17.

RL: Low-speed operation selection signal

OH: For inputting the contact signal of the thermal overload relay, installed outside the inverter, or that of the thermal sensor built in the motor. (N.C. contact)

Setting:0  
(factory-setting)

Setting:1

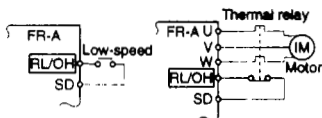

Set value	Function of terminal RL/OH		Comment
	RL (low-speed)	OH (external thermal relay input)	
0	●		(factory-setting)
1		●	

**Note:** If "1" is set in Pr.17, the inverter is expecting a thermal relay N.C. signal. RL is not active with Pr.17 equal to "1".

⚠ **CAUTION**

⚠ With the external thermal relay connected, do not switch Pr.17 setting to "0". Otherwise, the motor will be started by the start signal only.

**Pr.18** Setting the upper limit frequency for high speed operation

- Set this frequency value if operation is at a frequency higher than 120Hz.
- By setting the frequency for this parameter, the value set for Pr.1 (upper limit frequency) is automatically replaced with this setting.

**Pr.19** ⇨ Refer to Pr.3.

**Pr.20** ⇨ Refer to Pr.7.



Pr.22	Pr.23	Pr.66	Setting the stall prevention function operation level
-------	-------	-------	---

Pr.22	Stall prevention function operation level (current limit operation level)
-------	---

Pr.23	Stall prevention function operation level offset coefficient for double-speed operation (current limit level reduction rate offset coefficient at 400 Hz)
-------	---

Pr.66	Frequency for stall prevention function level reduction start frequency
-------	---

- Set the stall prevention function operation level (current limit level) for Pr.22. Usually, the setting should be 150% (factory-setting).
- If the motor is controlled to run at a speed faster than 60 Hz, there are cases when the motor cannot be accelerated because motor current does not increase. For such cases, it is possible to reduce the current limit level in the high frequency range to improve the motor operation characteristics. Usually, initial setting is Pr.66 = 60 Hz, Pr.23 = 100%.
- If "9999" (factory-setting) is set for Pr.23, the current limit level which is set for Pr.22 is applied to the range up to 400 Hz.

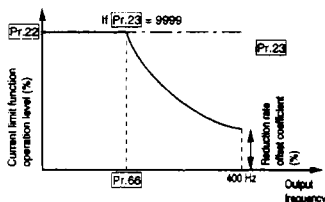

**Setting example:** Pr. 22 = 150%, Pr.23 = 100%, Pr.66 = 60 Hz

**Note:** The setting value of Pr. 22 can not be changed during operation even if Pr. 77 is set to 2 (writing during operation enabled).

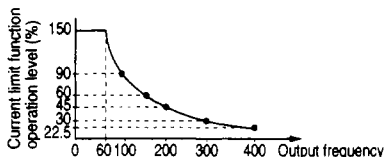

- Calculating the current limit function operation level

$$\text{Calculating the current limit function operation level} = A + B \times \left( \frac{\text{Pr.22}-A}{\text{Pr.22}-B} \right) \times \left( \frac{\text{Pr.23}-100}{100} \right)$$

where,

$$A = \frac{\text{Pr.66 (Hz)} \times \text{Pr.22(\%)}}{\text{Output frequency (Hz)}}, \quad B = \frac{\text{Pr.66 (Hz)} \times \text{Pr.22(\%)}}{400 \text{ (Hz)}}$$

**⚠ CAUTION**

⚠ Do not set the stall prevention operation level too small.  
If set so, torque generated will reduce.

Pr.24	Pr.25	Pr.26	Pr.27	= Refer to Pr.4.
-------	-------	-------	-------	------------------

## Pr.29 Selecting the acceleration/deceleration pattern

- The acceleration/deceleration pattern can be selected according to the application.

## Setting: 0 (linear acceleration/deceleration pattern)

This is the general acceleration/deceleration pattern and the motor is usually operated with this setting.

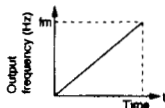

## Setting: 1 (S-pattern A)

This pattern is used for the applications which require quick acceleration or deceleration in the high speed range (over 60Hz). In this pattern, "fb" (base frequency) is taken as the point of inflection. Using this pattern, it is possible to set the acceleration/deceleration time which fits the motor torque reduction in the constant Hf output operation range over 60Hz. The pattern is applicable to controlling the spindle speed of machine tools.

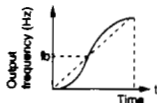

**Note:** For the value to be set, use the time necessary for acceleration up to the base frequency "fb" (Pr.3) instead of the acceleration/deceleration reference frequency (Pr.20). The actual acceleration time "t" seconds beyond the base frequency "fb" is calculated by the following formula.

$$t = \frac{4}{9} \times \frac{T}{(\text{Pr.3})^2} \times f^2 + \frac{5}{9} T$$

T: Set acceleration time (sec.)  
f: Set frequency (Hz)

## Setting: 2 (S-pattern B)

Acceleration/deceleration is always controlled in S-pattern within the range of "f2" (current frequency) to "f1" (target frequency). Therefore, shock during acceleration and deceleration is minimized and this control can be used to prevent loads from being toppled over.

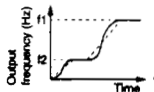

**Note:** Even if this parameter is written during operation, it will be validated after the inverter is stopped.

Pr.30	Pr.70	Setting the regenerative brake duty ratio
-------	-------	---

Pr.30	Selecting the regenerative brake duty ratio
-------	---

Pr.70	Setting the special regenerative brake duty ratio
-------	---

- These parameters should be set when regenerative brake is used frequently due to frequent starts and stop. In this case, since the brake resistor capacity must be increased, it is necessary to use an optional high-frequency brake resistor (Note 4).
- Setting method: After setting "1" for Pr.30 (changing the duty ratio), set the duty ratio (Note 1) for Pr.70.

Model	Setting for Pr.30	Setting range for Pr.70
FR-A024/ A044-0.4K to 3.7K	0 (factory-setting)	(Note 2)
	1	0 to 30% (note 3) (factory-setting: 0%)

- Notes:**
1. The brake duty ratio indicates "%ED" of the transistor of built-in brake.
  2. If Pr.30 = 0, Pr.70 is not displayed. If Pr.30 = 0, the brake duty will be 3%.
  3. If the set value for Pr.70 should be increased, the value must be smaller than the permissible brake duty ratio (refer to page 94) of the external brake resistor. (MRS or FR-ABR)
  4. Brake resistor cannot be connected to 0.1K and 0.2K. Because they have no brake transistor.

 **CAUTION**

 Do not set the brake duty above the permissible value of the brake resistor used, otherwise, overheating may occur.

Pr.31	Pr.32	Pr.33	Serial communication functions		
Pr.34	Pr.35	Pr.36			
Pr.31	Computer link E2PROM write validity	Pr.35	Start-up operation mode	Pr.50	Parity check
Pr.32	Communication speed	Pr.36	Station number selection	Pr.51	CR, LF code selection
Pr.33	Operation command selection	Pr.48	Data length	Pr.52	Number of communication retries
Pr.34	Speed command selection	Pr.49	Stop bit length	Pr.53	Communication check time interval

- These Parameters are for Communication Option CU03.  
If CU03 is not used, do not change the Factory setting of these Parameters.  
For information on setting value, refer to CU03 manual.

**Pr.37** Setting the speed display unit'

- It is possible to display the load speed such as a conveyor, instead of the motor. For this display, it is necessary to set the unit of display which meets the load's speed using the parameter unit.
- Setting should be made for the load's speed at 60Hz.

**Notes:**

- This setting is valid only for the monitor mode using the parameter unit. Parameters related with other speed information such as Pr.1 should be set in units of Hz.
- The motor speed is given by converting the output frequency. It does not agree with the actual motor speed.
- Due to the restriction on the resolution of the set frequency, display in the second place right of the decimal point may differ from the set value.

Set value	Display contents
0 (Factory-setting)	Display is given in output frequency.
0.01 to 9998	Set the speed of the load operating at 60Hz. Example: If the setting is "950" (r/min), value "950" is displayed when 60Hz is output. (No special unit system is displayed.)

**⚠ CAUTION**

- ⚠ Accurately set the operation speed. Failure to do so could lead to motor overspeeding and machine damage.

**Pr.38** Frequency at 5V (10V) input

- Set the output frequency corresponding to the external frequency reference signal of 5 VDC or 10 VDC.

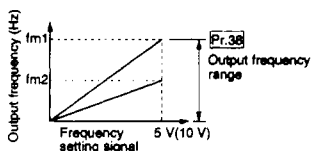
**Pr.39** Frequency at 20mA input

- Set the output frequency corresponding to the external frequency reference signal of 20mA.

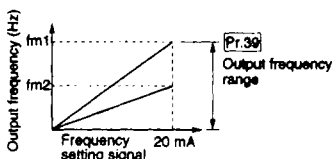

## Pr.40 Setting the allocation of output terminals

- For output terminals RUN and FU, the function can be allocated from the four functions in the table below. Setting is made in a two-digit number to be set for Pr.40. Each digit represents the function to be allocated to the individual terminals.

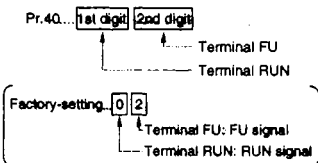

Set value	Function code	Function name	Description	Related Pr.
0	RUN	Inverter operating	Signal is output while the inverter is operating at a frequency higher than the starting frequency.	—
1	SU	Frequency arrived	Signal is output when the output frequency reaches the set frequency.	Pr.41
2	FU	Frequency sensing	Signal is output when a frequency higher than the specified frequency set for sensing level is output.	Pr.42 Pr.43
3	OL	Overload alarm	Signal is output while the current limit function is operating.	Pr.22
4	OMD	Open motor circuit detection	This is output when the output current drops below a set value during inverter operation.	Pr.62 Pr.63

**Note:** If the setting of the 1st digit of Pr.40 is "0" (RUN), the 1st digit value is not displayed. If "02" is set, for example, "2" is displayed.

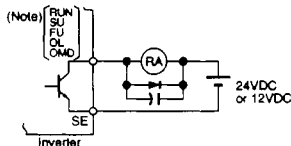

**Note:** If the direction that the voltage is applied is mistaken, the inverter could be damaged. Take special care against mistaken wiring of the diode connection direction, etc.

## Pr.41 Adjusting the SU frequency bandwidth

- It is possible to adjust the width to recognize the arrival of the output frequency to the operation frequency. Setting is made in the range of 0 to  $\pm 100\%$  of the operation frequency, and when the output frequency reaches the range defined by the set bandwidth, the output signal changes state.

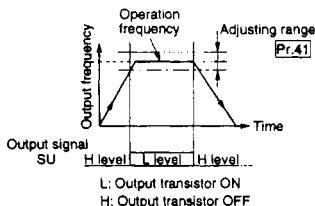

**Pr.42** **Pr.43** **Setting the sensing for output frequency**

**Pr.42** Output frequency sensing

**Pr.43** Output frequency sensing in reverse rotation

- The signal goes to the L (conducting) level if the output frequency goes beyond the frequency set for the sensing level (the value set for Pr.42). If the output frequency is below this level, the signal is in the H (open) level. This signal ON/OFF operation can be used to control the electromagnetic brake, etc.
- If a value is set for Pr.43, frequency sensing is possible for reverse rotation operation. In this case, the value set for Pr.42 is used only for forward rotation operation. For vertical motion, where the timing to apply the electromagnetic brake should be changed between the upward and downward motion, setting for Pr.43 will be effective. The factory-setting is "9999", in which setting, the value set for Pr.42 is applied for both forward and reverse rotation operation.

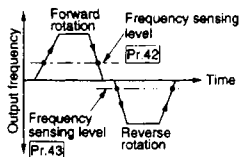
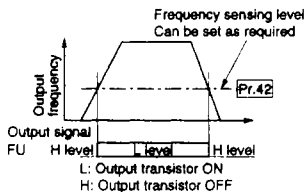

• **Example of output frequency sensing**

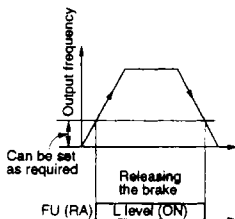
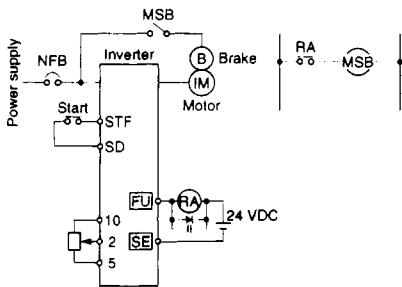

Pr.44	Pr.45	Pr.46	Pr.47	Setting the second control functions
-------	-------	-------	-------	--------------------------------------

Pr.44	2nd acceleration/deceleration time
-------	------------------------------------

Pr.45	2nd deceleration time
-------	-----------------------

Pr.46	2nd torque boost (manual)
-------	---------------------------

Pr.47	2nd V/F (base frequency)
-------	--------------------------

- According to the external contact signal input across terminals RT and SD, the setting for the acceleration/deceleration time, torque boost, etc. can be changed collectively.
- This feature is effectively used when a single inverter controls two motors, traverse operation motor and vertical operation motor, for which the parameter set value differs from each other or when speed changes require different responses.

Control function	Parameter No.	Signal across RT and SD	
		OFF	ON
Acceleration time	Pr.7	●	
	Pr.44		●
Deceleration time	Pr.8	●	
	Pr.45		●
Torque boost (manual)	Pr.0	●	
	Pr.46		●
Base frequency	Pr.3	●	
	Pr.47		●

- Before shipping, the output shutoff function is allocated to terminal MRS/RT.

**Note:** To set different time for acceleration and deceleration:  
Set acceleration time for Pr.44 and deceleration time for Pr.45.

Pr.48	Pr.49	Pr.50	⇨ Refer to Pr.4.
-------	-------	-------	------------------

Pr.51	Pr.52	Pr.53
-------	-------	-------

Pr.54	Selecting the FM terminal function
-------	------------------------------------

- At the output terminal FM, an ammeter (1mA full-scale) or a digital counter can be connected. For the display content, either output frequency or motor current (output current) may be selected.

Set value	Description
0	Output frequency (factory-setting)
1	Motor current (output current)

**Note:**

If "9999" (factory-setting) is set for Pr.45, the value set for Pr.44 is used for the second acceleration/deceleration time and second deceleration time.

If the general-purpose magnetic flux vector control mode is selected by Pr.80, setting for Pr.0, Pr.3, Pr.46, and Pr.47 are all ignored.

The second acceleration/deceleration time set for Pr.44 and Pr.45 is the time in reference to the value set for Pr.20 (acceleration/deceleration reference frequency) as with the time set for Pr.7 and Pr.8.

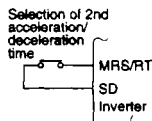
**Note:**

For output frequency and motor current, gain can be adjusted with Pr.55 (Reference for frequency monitor) and Pr.56 (Reference for current monitor).



**Pr.55** Reference for frequency monitor

- Set the output frequency at which the pulse-train output frequency, across terminals FM and SD is 1440Hz. This setting is valid when "0" (output frequency) is set for Pr.54 (selection of FM terminal function).

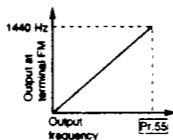

Factory-setting ... 60Hz

**Note:** The maximum pulse-train output frequency at terminal FM is 2400Hz.

**Pr.56** Reference for current monitor

- Set the output current (motor current) at which the pulse-train output frequency, across terminals FM and SD, is 1440Hz. This setting is valid when "1" (motor current) is set for Pr.54 (selection of FM terminal function).

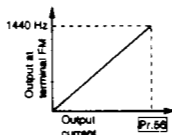

Factory-setting ... Rated output current of inverter

**Note:** The maximum pulse-train output frequency at terminal FM is 2400Hz.

**Pr.57** **Pr.58** Operation restart after instantaneous power failure

**Pr.57** Free-wheeling time for restart

**Pr.58** Start-up time for restart

- At an occurrence of instantaneous power failure, it is possible to restart the inverter without stopping (in free-wheeling state) the motor when power is restored.

**Note:** Restart operation after instantaneous power failure is made in the reduced voltage start method in which the output voltage is increased gradually while maintaining the set frequency, independent of the motor's free-wheeling speed.

Differing from the method as used with FR-A100 and A200, in which the motor free-wheeling speed is sensed (speed search method), output frequency before the momentary power interruption is output. If power off state continues for more than 0.2 seconds, the frequency before the power interruption cannot be retained and, in such case, the inverter restarts from 0Hz.

## ● Pr.57 (free-wheeling time)

Set Value	Possibility of Restart
9999 (factory-setting)	Impossible
0, 0.1 to 5*	Possible

Free-wheeling time indicates the time for which the inverter waits for the control for restart.

- \* If "0" is set for Pr.57, the following stand-ard time is set for the free-wheeling time. Generally, the operation is possible in this setting, the set time can be adjusted in the range of 0.1 to 5 seconds meeting the moment of inertia of load ( $GD^2$ ) and torque.

0.1K to 1.5K.....0.5 sec.

2.2 K to 3.7K.....1.0 sec.

## ● Pr.58 (start-up time)

Usually, the setting of 0.5 seconds (factory-setting) need not be changed for ordinary operation. However, it is possible to adjust the output voltage start-up time in the range of 0.1 to 5 seconds meeting the load specification (moment of inertia and torque).

**⚠ CAUTION**

⚠ When the automatic restart after instantaneous power failure function has been selected, keep away from the motor and machine.

When the automatic restart after instantaneous power failure function has been selected, apply the supplied CAUTION seal to an easily identified place.

**Pr.59** Input terminal allocation

- Eight types of function can be allocated without restriction to the control signal input terminals (the four terminals RL/OH, RM/AU, RH, and MRS/RT).

Setting is accomplished by allocating a four-digit value to Pr.59.

Each digit represents the function for one of the terminals.

Set value	Function Abbreviation	Function Name	Related Pr.	Remarks
9999		Same as function before allocation	Pr.44, Pr.17, Pr.74	Factory setting
0	AU	Current input selection	Pr.74	
1	RH	Multiple-speed selection (high speed)	Pr.4	
2	RM	Multiple-speed selection (middle speed)	Pr.5	
3	RL	Multiple-speed selection (low speed)	Pr.6	
4	OH	External thermal relay input	Pr.17	
5	STOP	Start signal self-holding selection	—	(Note 5)
6	MRS	Output stop	Pr.44	
7	RT	2nd acceleration/deceleration selection	Pr.44	
8	RT	2nd acceleration/deceleration selection*	Pr.44	
9	REX	15-speed selection	Pr.126 to 133	

- \* If 9999 is set for Pr.80, it is possible to switch between V/F control and general-purpose magnetic flux vector control by using the RT terminal.

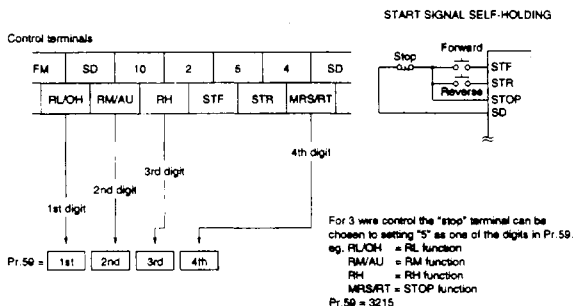

- When the first digit of Pr.59 is "0", the first digit is not displayed.

- Notes:**
1. It is also possible to set the same function for two or more terminals. In this case the logical sum of the inputs at each of the terminals is calculated.
  2. If "8" is set for one of the digits of the Pr.59 setting, and switching between V/F control and general-purpose magnetic flux vector control is executed using the RT terminal, the set values for 2nd acceleration/deceleration time, 2nd torque boost, and 2nd V/F will become effective simultaneously with the RT input, but the switch between V/F control and general-purpose magnetic flux vector control will only take effect when the inverter is stopped.
  3. When a value between 0 and 8888 is set for Pr.59, terminal functions cannot be selected using Pr.44, Pr.17, or Pr.74.
  4. The conventional terminal functions are determined by Pr.17, Pr.44 and Pr.74 only when Pr.59 is set to 9999.
  5. The start signal self-hold function can be selected.
    - The inverter will start when STF (STR) is on.
    - The operation will continue even if STF (STR) is released after that.
    - To stop, release STOP-SD with the stop switch. The inverter will stop.
  6. When connecting a high power factor converter (FR-HC), assign 6 to one of the control terminals with Pr. 59 "Input terminal allocation", and connect to the high power factor converter (FR-HC) RDY terminal.

**Pr.60** Input filter time constant

- Allows the setting of the built-in filter time constant for the external voltage or current frequency setting signal input section. Effective for eliminating noise in the frequency setting circuit.
- Increases the filter time constant if stable operation cannot be performed due to noise. A larger set value results in lower response.

**Pr.61** Tone control selection

It is possible to control the motor output tone according to the setting of Pr.61.

- The tone control function automatically controls the carrier frequency to change metallic motor noise to synthesized tone which is softer to environment.
- The tone control function is more effective for lower carrier frequency. Use this function as a measure to reduce motor noise while restricting electrical noise and leak current.

Set Value	Tone Control Selection
0	No tone control (factory-setting)
1	Tone controlled

**Note:** This function cannot be used if the setting for Pr.72 (PWM carrier frequency) is larger than 10 kHz. Though setting over 10 kHz is possible, tone control will not be available.

**Pr.62** **Pr.63** Open motor circuit detection function

**Pr.62** Open motor circuit detection level

**Pr.63** Open motor circuit detection time

A signal is output if the inverter's output current drops below the Pr.62 set value during inverter operation. The zero current detection signal (OMD) is assigned to the output terminals with Pr.40.

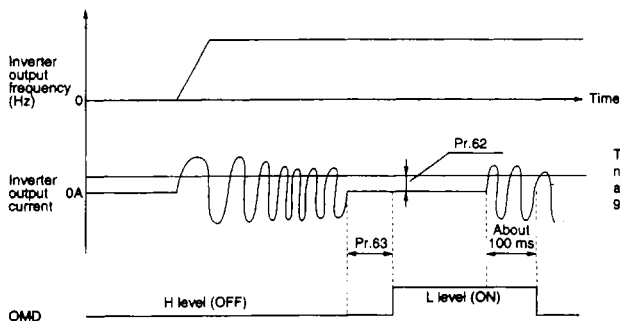

The zero current will not be detected if Pr.62 and Pr.63 are set to 9999.

Pr.64	Pr.76	Pr.81	Slip compensation
Pr.64	Constant output range slip compensation selection		
Pr.76	Slip compensation response time		
Pr.81	Motor rated slip		

The motor slip can be estimated from the inverter's output current to maintain the motor speed at a constant level.

Pr.	Function	Explanation of function	Factory setting
76	Slip compensation response time	The slip compensation response time is set. (Note 1)	0.5 sec
81	Motor rated slip (%)	The motor's rated slip is set.	9999

Pr.81 Rated slip =  $\frac{\text{Synchronous speed at base frequency} - \text{Rated speed}}{\text{Synchronous speed at base frequency}} \times 100 (\%)$

Pr.64 selects whether to activate the slip compensation at the constant output range (frequency range higher than frequency set with Pr.3).

Pr.64 setting value	Function
0	Does not compensate the constant output range slip.
9999	Compensates the constants the output range slip.

**Note 1)** When this value has a low setting, the response will become quicker, however, the occurrence of the OVT error will increase if the load inertia is large, etc.

**Note 2)** Slip compensation will not be activated if one or both of Pr.64 and Pr.81 are set to 9999.

## Pr.65 Selection of retry

- This parameter should be set to automatically restart the inverter to continue operation by resetting it if an inverter alarm occurs. "OPT" is displayed during retry.

**⚠ CAUTION**

- ⚠ When the retry function has been selected, keep away from the motor and machine unless required. They will start suddenly (after a predetermined time has passed) at occurrence of an alarm.
- When the retry function has been selected, apply the accessory CAUTION seal to a place where it is easily identifiable.

Set value	Contents of retry
0	No retry function (factory-setting)
1	Retry is valid in the case of OV1 to OV3 (shutoff due to overvoltage in regeneration)
2	Retry is valid in the case of OC1 to OC3 (shutoff due to overcurrent)
3	Retry is valid in the case of OV1 to OV3 (shutoff due to overvoltage in regeneration), or OC1 to OC3 (shutoff due to overcurrent)

## Pr.66 Refer to Pr.22

## Pr.67 Pr.68 Pr.69 Retry function

Pr.67 Retry count after an occurrence of inverter alarm

Pr.68 Retry waiting time

Pr.69 Clearing retry count

- The retry function continues inverter operation by automatically resetting and restarting the inverter if an inverter alarm occurs.
- The number of retries is set in Pr.67.

Set value for Pr.67	Alarm signal output		Retry count
	Output	Not output	
0	—	—	Retry not executed (factory-setting)
1 to 10	×	○	1 to 10
101 to 110	○	×	1 to 10

x = NO    ○ = YES

- Waiting time until the restart, after occurrence of an inverter alarm is set for Pr.68 within the range of 0.1 to 360 seconds.
- It is possible to know the total number of success of the retry for restart by reading Pr.69. If "0" is set, the accumulated count is cleared.

- Notes:**
1. The inverter automatically restarts the operation after the retry waiting time set for Pr.68. Therefore, if the retry function is used, pay sufficient care so that restarting of the inverter will not constitute hazards to the operators.
  2. In the inverter reset operation by the retry function, the accumulated data of electronic thermal relay and regeneration brake duty ratio, etc. is not cleared. This reset is different from the power reset operation.

Pr.70 ⇒ Refer to Pr.30. (page 71)

Pr.71 Selecting the applicable motor

- When a Mitsubishi constant torque motor is used, set "1" for Pr.71 independent of the control type (V/F control, general-purpose magnetic flux vector control). The thermal characteristics of the electronic thermal relay are set for the constant torque motor.

Set Value	Characteristics of Electronic Thermal Relay
0	For general-purpose motors
1	For Mitsubishi constant torque motors

- Note**
- Select the inverter capacity carefully as the constant torque motor output current is larger than of the standard motor.
  - When two or more constant torque motors are run synchronously, they are liable to cause torque imbalance because of their smaller slip than the standard motors.

### ⚠ CAUTION

- ⚠ Set this parameter correctly according to the motor used. Incorrect setting may cause the motor to burn due to overheat.

Pr.72 Changing the PWM carrier frequency

It is possible to change the noise level of the motor by the setting of Pr.72.

Factory-setting ... 1kHz (not low-noise operation)

- By changing the setting of Pr.72, operation noise is influenced as indicated in the table at the right.

Value Set for Pr.72	To Increase	To Reduce
Motor noise	Lowered (note1) in the range higher than approximately 7kHz, low-noise operation is possible.	Increases
Generated noise	Increases (note 2)	Reduces
Leak current	Increases (note 2)	Reduces

- During the operation of the inverter, the change or writing of the set values is restricted to either of the following ranges.

- 0.7kHz to 1.1kHz
- 1.2kHz to 14.5kHz

The change or writing of the set values beyond the individual ranges is not permitted.

- Notes:**
- If the inverter is operated by setting a value larger than 2kHz for Pr.72 while ambient temperature is higher than 40°C (104°F), it is necessary to reduce the rated output current of the inverter (Refer to page 117).
  - If PWM carrier frequency is increased, noise and leak current will increase. Therefore, proper measures must be taken (Refer to page 110.)

- If the mechanical system vibrates abnormally due to resonance, vibration might be reduced by changing the setting of Pr.72.

**Pr.73** Selecting the frequency command voltage range

- It is possible to change the input specification (terminal 2) according to the frequency reference voltage signal.

If voltage of 0 to 10 VDC should be input, change the value to equal the input specification.

Set Value	Input Voltage at Terminal 2
0	For 0 to 5 VDC input (factory-setting)
1	For 0 to 10 VDC input

**Notes:** 1. To change the maximum output frequency corresponding to the input of the maximum frequency command voltage (current), value should be changed for Pr.903 (frequency setting voltage gain) or Pr.905 (frequency setting current gain). It is not necessary to input a command voltage (current).

The acceleration/deceleration time is not influenced by a change in Pr.73 setting since it defines the gradient up to the acceleration/deceleration reference frequency.

- Set "0" for Pr.72 when the inverter is operated with a frequency reference potentiometer connected.

**Pr.74** Selecting the current input signal/Starting command • rotation direction command selection

- The inverter can be operated by the frequency setting current signal (4 to 20mA DC). If the current input signal function is set for the RM/AU terminal, it is possible by closing the circuit across terminals AU and SD to use this function.

The external run terminal function can be set for the starting command and rotation command.

Set Value	Input at Terminal RMAU
0/100	For multiple-speed selection (factory-setting is "0")
1/101	For current input selection

**Pr.74 = 0, 1**

STF	STR	Run state
0	0	Stop
1	0	Forward
0	1	Reverse
1	1	Stop

**Pr.74 = 100, 101**

STF	STR	Run state
0	0	Stop
1	0	Forward
0	1	Stop
1	1	Reverse

0: open

1: short

**Pr.75** Reset selection/detection of parameter unit disconnection

- It is possible to select the reset function for terminal RES. It is also possible for the parameter unit disconnection alarm function to be selected if the parameter unit is disconnected.
- If the inverter is operated without selecting the parameter unit disconnection detection function, inverter operation will be continued even after the parameter unit is disconnected from the inverter, which will create hazardous situation.
- Therefore, to ensure safe operation, it is recommended that the parameter unit disconnection detection function be selected.
- The stop key on the parameter unit can be activated to work in all operation modes.



Set Value	Reset Conditions	External Terminals	Key Operation (Parameter Unit)	Operation after Disconnection of Parameter Unit	PU STOP Key
0	Reset input is possible at any time.	○	×	Operation continues if the parameter unit is disconnected.	No function in Ext mode.
1	Reset input is possible only when the protection function is activated.	○	○		
2	Reset input is possible at any time.	○	×	When the parameter unit is disconnected, the ALARM LED is lit and inverter output is shut off.	
3	Reset input is possible only when the protection function is activated.	○	○		
14	Reset input is possible at any time (factory-setting). (Note 1)	○	×	Operation continues if the parameter unit is disconnected.	When stop key on PU is pressed in any operation mode, motor stops. (Note 2)
15	Reset input is possible only when the protection function is activated.	○	○		
16	Reset input is possible at any time.	○	×	When the parameter unit is disconnected, the ALARM LED is lit and inverter output is shut off.	
17	Reset input is possible only when the protection function is activated.	○	○		

○: Yes    ×: No

- Notes:**
- If the circuit across terminals RES and SD is closed while the inverter is operating, the inverter shuts off the output while the terminals are closed. The data related to the electronic thermal relay and the regenerative brake duty ratio is cleared and the motor free wheels.
  - Procedure for restarting after stopping with the parameter unit stop key in Ext mode.
    - After the inverter has stopped, turn off the start signal (STF/STR).
    - Press the parameter unit's external operation key.
    - Switch ON the start command (STF/STR).
 Apart from the procedure above, operation can also be restarted by switching the power off and back on, or by resetting the inverter by closing the circuit across the reset terminals.
  - When operation is stopped in external mode using the parameter unit stop key, "E0" is displayed on the parameter unit.

**⚠ CAUTION**

- ⚠ With the start signal input, do not reset the inverter.  
After reset, the inverter will start instantaneously, creating a hazardous condition.

Pr.76 Refer to Pr.64

Pr.77 Disabling parameter write

- It is possible to disable writing of the parameters.

Set Value	Write Disable Function
0	Parameter writing enabled (during stopped) (factory-setting) (Note 1)
1	Parameter writing disabled (Note 2)
2	Parameter writing enabled during operation (Note 3)

- Notes:**
- Parameters related to monitoring (Pr.54 to Pr.56), multiple-speed input (Pr.4 to Pr.6, Pr.24 to Pr.27, Pr.126 to Pr.133) can be set any time.
  - Writing of Pr.77 and Pr.79 (operation mode selection) is always possible.
  - While the inverter is operating, writing of Pr.22, Pr.71, Pr.79, and Pr.80 is not possible.
  - Writing of Pr.990 to Pr.997 is possible.

### ⚠ CAUTION

- ⚠ During operation, do not change the parameter settings unnecessarily, the new settings may cause an alarm may occur in the inverter, causing the motor to coast.

Pr.78 Reverse lockout

- Select the reverse rotation lockout function if reverse rotation operation due to erroneous input of the reverse start signal causes a problem.

**Note:** Both parameter unit and external operation are effective.

Set Value	Rotation Direction
0	Forward and reverse (factory-setting)
1	Reverse rotation disabled
2	Forward rotation disabled

Pr.79 Selecting the operation mode

- The inverter operation modes include external operation mode in which external signals are used to control the inverter and the PU operation mode. It is possible to select either or both of these modes for inverter operation.

Set Value	Operation Method
0	Switching the operation mode between the external operation mode and the PU operation mode (factory-setting)
1	PU operation mode only
2	External operation mode only
3 (Note 1)	Operation frequency: To be set by parameter unit Start signal: External signal
4 (Note 1)	Operation frequency: External signal Start signal: To be input by the parameter unit
6 (Note 2)	Switch over mode
7 (Note 3)	Edit enable signal mode (valid only when Pr.44 = 9999)
8 (Note 4)	Local/auto external signal selection mode.

Notes: 1. In the combined mode operation, the following signals are valid.

Set Value	Operation Frequency	Start Signal
3	Parameter unit <ul style="list-style-type: none"> <li>• Direct setting and setting with [▲] and [▼] keys.</li> </ul>	Terminal signals <ul style="list-style-type: none"> <li>• STF</li> <li>• STR</li> </ul>
4	Terminal signals <ul style="list-style-type: none"> <li>• Across 2 and 5: 0 to 5 VDC</li> <li>• Across 2 and 5: 0 to 10 VDC</li> <li>• Across 4 and 5: 4 to 20mA DC</li> <li>• Multiple-speed selection (Pr.4 to Pr.6, Pr.24 to Pr.27)</li> </ul>	Parameter unit <ul style="list-style-type: none"> <li>• Forward key</li> <li>• Reverse key</li> </ul>

2. The external run mode, PU run mode and computer link mode can be changed during running.

Set Value	Mode Change	Operation
6	External → PU	① Press the PU key on Parameter Unit. <ul style="list-style-type: none"> <li>• The rotation direction will be the same direction as during external run.</li> <li>• The set frequency will be the value set with the potentiometer.</li> </ul> (Note that the setting value will be lost when the power is turned OFF.)
	External → Computer	① Exchange PU with the serial link option (FR-CU03) ② Commands will be transmitted from the computer. <ul style="list-style-type: none"> <li>• The rotation direction will be the same direction as during external run.</li> <li>• The set frequency will be the value set with the potentiometer.</li> </ul>
	PU → External	① Press the External key on Parameter Unit <ul style="list-style-type: none"> <li>• The run command and frequency setting will be determined by the terminal input.</li> </ul>
	PU → Computer	① Exchange PU with the serial link option (FR-CU03) ② Commands will be transmitted from the computer. <ul style="list-style-type: none"> <li>• The run state will continue to be the PU run state.</li> </ul>
	Computer → External	① Exchange the serial link option (FR-CU03) with the PU. ② Press the External key on Parameter Unit. <ul style="list-style-type: none"> <li>• The run command and frequency setting will be determined by the terminal input.</li> </ul>
	Computer → PU	① Exchange the serial link option (FR-CU03) with the PU. ② Press the PU key on Parameter Unit. <ul style="list-style-type: none"> <li>• The run state will continue to be the serial link run state.</li> </ul>

Notes: 3. In the edit enable signal mode, the following functions are available. (Refer to page 35.)

Set Value	Signal (MRS and SD)	Function and Operation
7	Closed	<ul style="list-style-type: none"> <li>• In the external operation mode, output is shut off.</li> <li>• Operation mode can be switched to the PU mode.</li> <li>• In the PU mode, values set for parameters can be changed.</li> <li>• Operation in the PU operation mode is enabled.</li> </ul>
	Open	<ul style="list-style-type: none"> <li>• Operation mode is forcibly changed to the external operation mode.</li> <li>• Operation in the external operation mode is enabled.</li> <li>• Operation mode change to the PU operation mode is disabled.</li> </ul>

4. In local/auto external signal selection mode selection is made as indicated below. (Refer to page 37.)

Mode change is not allowed during operation. Change the mode only while the inverter is stopped.

Set Value	Signal (RH and SD)	Mode
8	Closed	External operation mode only (not switchable to the PU operation mode)
	Open	PU operation mode only (Not switchable to the external operation mode)

**Pr.80** Capacity of applicable motor (for general-purpose magnetic flux vector control)

- When the general-purpose magnetic flux vector control (Refer to page 53) is selected, set the capacity (kW) (HP) of the motor to be used.  
If a constant torque motor is used, set "1" for Pr.71 (selecting the applicable motor).

**Note:** The following conditions apply to the selection of general-purpose magnetic flux control mode.

1. For general-purpose squirrel cage standard motors (0.1kW (1/8HP) or larger), motor capacity is equivalent to or one rank below the capacity of the inverter.  
The Mitsubishi constant torque motor is SF-JRC 200V class, 4 pole and can be applied to 0.4kW (1/2HP) to 3.7kW (5HP). For parameter set value for constant torque motors, refer to the explanation for Pr.71.
2. The number of poles is 2, 4, or 6. It is not necessary to set the number of poles. (For constant torque motors, 4 poles only)
3. The motor is controlled by its own inverter.
4. Wiring length between the motor and the inverter is within 30m (98.46 feet). If the length exceeds 30m (98.46 feet), refer to the instructions given in page 55.  
If the conditions indicated above are not satisfied, satisfactory operation performance may not be obtained.

- The general-purpose magnetic flux vector control for FR-A024 series differs from the magnetic flux control for FR-A200 series.

**Pr.81** Refer to Pr.64

Pr.91	Pr.92	Pr.93	Frequency jump
Pr.94	Pr.95	Pr.96	

Resonance can occur at certain speeds in some applications when a motor is driven by an inverter. To avoid this resonance upto three jump positions can be set, by defining the upper and lower frequency limits in Pr.91 to Pr.96.

The 1A, 2A or 3A setting value becomes the jumping point, the inverter will run at that frequency while in the frequency jump range.

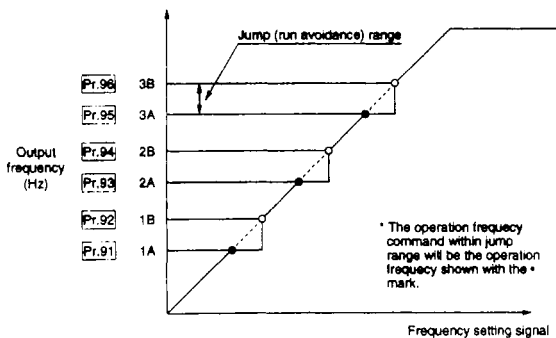

- Notes)**
- 1: Frequency jump will not function if 9999 (default value) is set.
  - 2: During acceleration and deceleration, the frequency in the setting range will be passed through.

Pr.126	Pr.127	Pr.128	Pr.129	⇒ Refer to Pr.4.
Pr.130	Pr.131	Pr.132	Pr.133	

**Pr.900** Calibrating the output at terminal FM

- It is possible to calibrate the meter connected to the FM terminal using the parameter unit. The calibration function is valid to both monitor functions selected by Pr.54.
- At the terminal FM, pulses are output as illustrated below. However, by setting a proper value for Pr.900, the indication of the meter connected to the inverter can be calibrated by using the parameter unit without connecting a variable resistor. (Refer to page 49.)
- Monitoring using a digital counter

The pulse-train output at the FM terminal is used to display the monitor data on the digital counter. At the full-scale value, explained in the item for Pr.55, 1440Hz is output. If the operation frequency is selected to be monitored, the ratio of the output frequency at the FM terminal can be set by Pr.55.

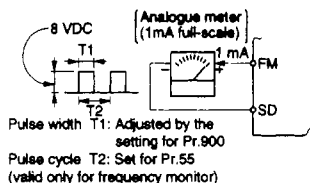

**Note:** Factory-setting (at 60Hz): 1mA corresponds to the full-scale indication and FM terminal output frequency of 1440Hz.

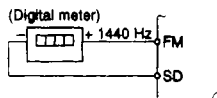

Pr.902	Pr.903	Pr.904	Pr.905	Adjusting the gain and bias for the frequency setting signal
--------	--------	--------	--------	--

Pr.902	Bias for frequency setting voltage
--------	------------------------------------

Pr.903	Gain for frequency setting voltage
--------	------------------------------------

Pr.904	Bias for frequency setting current
--------	------------------------------------

Pr.905	Gain for frequency setting current
--------	------------------------------------

- The output frequency can be set corresponding to the frequency reference signal (0 to 5 VDC, 0 to 10 VDC, 4 to 20mA DC) as required. (Refer to page 50.)

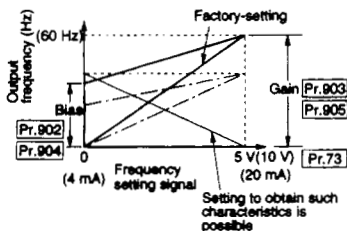

Example: To set bias and gain by applying V1 (V) and V2 (V) across terminals 2 and 5, respectively.

(Between terminals 4 and 5, set bias by applying a current of 11mA and gain by applying a current of 12mA.)

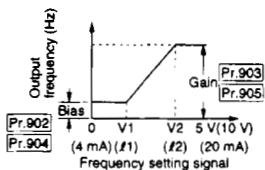

**Note:** When bias and gain are set using these parameters, setting for Pr.38 (frequency at 5 VDC input) or Pr.39 (frequency at 20mA input) is automatically changed.

⚠ CAUTION

- ⚠ Take care when setting Pr.902 or 904 to any value other than "0". In this case, without the speed command, the motor starts at the preset frequency by merely switching the start signal on.



**Pr.990** Selecting key click sound (parameter unit)

- This parameter is used to select whether click sound is output or not in response to the key operation on the parameter unit. (Refer to page 52).

Set Value	Key Click Sound
0	Not output (factory-setting)
1	Output

**Pr.991** Selection of the parameter unit display data

- The contents of monitor display of the parameter unit can be fixed (or given priority) to the set frequency.

Set Value	Contents
0	Standard specification
1	Set frequency is given priority. (Note 1)
2	Fixed to the set frequency. (Note 2)

- Note:** 1. Pressing the [▲] or [▼] key during the operation frequency monitor will change the display to the set frequency.  
At 10 seconds after the [▲] or [▼] key has been released, the monitor display will automatically return to the operation frequency.
2. The monitor display is given only when the [MONITOR] key is pressed.

**Pr.996** Clearing the alarm

- If the [WRITE] key is pressed after reading the data set for Pr.966, the inverter alarm is cleared. (Refer to page 45)

**Note:** The accumulated values for the electronic thermal relay and the retry count are not cleared.

- When the data in Pr.996 is read, "Er.Ll" is always displayed. It blinks on and off when the alarm is cleared.

**Pr.997** Resetting the inverter

- It is possible to reset the inverter using the [WRITE] key after reading the data in Pr.997 without inputting a signal to the RES terminal or turning on and off the power. (Refer to page 48).

**Note:** In this reset operation, the accumulated values for the electronic thermal relay and the retry count are cleared.

- When the data in Pr.997 is read, "rE 5r" is always displayed. The display is cleared once and then the initial screen appears when the inverter is reset.

Pr.998	Pr.999	Initializing the parameters
	Pr.998	Parameter all clear
	Pr.999	Parameter clear

- By pressing the [WRITE] key after reading the data in Pr.998 or Pr.999, the values set for the parameter can be changed to the values initially set before shipping (factory-setting) collectively.
- The parameters for which the set values can be changed collectively are:
  - Pr.998 ... All parameters
  - Pr.999 ... Parameters excluding those used for calibration (Pr.900 to Pr.905).
- If the parameter write is disabled (Pr.77 = 1, or during operation in the setting of Pr.77 = 0), you may not change the setting of the parameters.
- When the set values for the parameters are read, the display in the display unit is:  
"ALL" for Pr.998 and "Pr.Lr" for Pr.999.  
The display blinks on and off when the parameters are initialized.

## 23. INSPECTION AND MAINTENANCE

The general-purpose inverter is static equipment mainly consisting of semi-conductor devices. To prevent problems occurring due to environmental conditions such as high temperature, humidity, dust, and vibration, or aging of the component parts, inspection at regular intervals is necessary.

### 23.1 Precautions on Inspection and Maintenance

After the power is turned off, the smoothing capacitor remains charged at high voltage for a while. Remove the front cover and wait until the POWER indicating lamp (refer to page 3) on the printed circuit board goes off. Start inspection or maintenance several minutes after the turning off of the POWER indicating lamp.

### 23.2 Inspection Items

#### (1) Daily inspection

Check the following items during operation.

- The motor operates properly.
- The environment is normal.
- The cooling system is normal.
- There is no unusual vibration or noise.
- There is no overheating or discoloration.

During operation, check the inverter input/output voltage with a multimeter.

#### (2) Regular inspection

Check the following items which may be checked only after stopping the inverter at regular intervals.

- Check that the cooling system is correct. Clean the air filter, etc.
- Tighten the screws and bolts. Since screws and bolts will loosen due to vibration and thermal expansion, check the screws and bolts and tighten them if loose.
- Check the conductors and insulators for corrosion and damage.
- Measure insulation resistance.
- Check the cooling fan, smoothing capacitor, and relay. Replace a defective part.

#### (3) Testing insulation resisting using a Megger

- To test the insulation resistance of the external circuit, disconnect all wires from the inverter terminals so that test voltage will not be applied to the inverter circuits.
- For the continuity test of the control circuit, use a multimeter (high resistance range). Do not use a Megger or buzzer for the test.
- Conduct the insulation resistance test on the inverter main circuit only. Do not conduct the test on the control circuits. (Use a 500 VDC megger.)

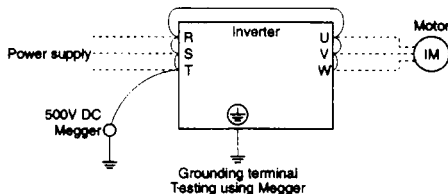

## 23. INSPECTION AND MAINTENANCE

### Daily inspection and regular interval inspection

Location	Item	Contents	Inspection interval			Inspection method	Judgment	Instrument
			Daily	Interval				
				1 year	2 years			
Overall inspection	Environment	Check ambient temperature, humidity, dust, etc.	○			Refer to cautions in page 9.	Ambient temperature: -10°C (14°F) to +50°C (122°F) (without freezing) Humidity: Less than 90% (non-condensation)	Thermometer, hygrometer, recorder
	Equipment	Vibration and noise	○			Visual inspection, inspection by ear.	Must be free of abnormal vibration and noise.	
	Supply voltage	Main circuit voltage	○			Measure voltage across terminals R, S, and T.	170 to 242V 50Hz (323 to 506V) 50Hz 170 to 253V 60Hz (323 to 506V) 60Hz	Tester, digital multimeter
Main circuit	Overall inspection	(1) Insulation resistance (between the main circuit terminal and grounding terminal)		○	○	(1) After disconnecting all wires at the inverter terminals, close R, S, T, U, V, and W terminals. Measure insulation resistance between the point where these terminals are connected and the grounding terminal using a Megger. (2) Tighten the loose screws and bolts. (3) Check visually.	(1) Must be larger than 5 MΩ. (2) (3) Must be free of abnormalities.	500 VDC Megger
		(2) Loose connection (3) Overheat on component part (4) Cleaning		○	○			
	Conductors and wires	(1) Distortion in conductors (2) Damage on coating of the conductors		○	○	(1) (2) Visual inspection	(1) (2) Must be free of abnormalities.	
	Terminal block	Damage		○		Visual inspection	Must be free of abnormalities.	

## 23. INSPECTION AND MAINTENANCE

Daily inspection and regular interval inspection

Location	Item	Contents	Inspection interval			Inspection method	Judgment	Instrument
			Daily	Interval				
				1 year	2 years			
Main circuit	Inverter module Converter module	Resistance across the terminals			○	After disconnecting all wires at the inverter terminals, measure resistance across terminals R, S, T and, P, N, and U, V, W and P, N with a multimeter in the $\times 1\Omega$ range.		Analog multimeter
	Smoothing capacitor	(1) Leak of fluid (2) Protrusion of the safety valve, or bulging. (3) Measuring the capacitance	○ ○		○	(1) (2) Visual inspection (3) Measure with a capacitance measuring instrument.	(1) (2) Must be free of abnormalities. (3) High than 85% of the rated capacity.	Capacity meter
	Relay	(1) Chattering noise during operation (2) Smoothness on contact		○ ○		(1) Listening inspection (2) Visual inspection	(1) Must be free of abnormalities. (2) Must be free of abnormalities.	
	Resistor	(1) Crack on resistor insulator (2) Disconnection		○ ○		(1) Visual inspection Cement resistors, wire wound resistor (2) Disconnect the wire at one side and measure resistance with a multimeter.	(1) Must be free of abnormalities. (2) Must be within $\pm 10\%$ of the indicated resistance.	Tester, digital multimeter
Control circuit Protection circuit	Operation check	(1) Check the balance of interphase output voltage by operating the inverter independently. (2) Conduct the sequence protection operation test to check the protection and display circuits.		○ ○		(1) Measure voltage across the inverter output terminals U, V, W. (2) Short the inverter protection circuit outputs.	(1) Imbalance should be within 4V (for 200V), 8V (for 400V). (2) The alarm should be output.	Digital multimeter, rectifier voltmeter

## 23. INSPECTION AND MAINTENANCE

### Daily inspection and regular interval inspection

Location	Item	Contents	Inspection interval			Inspection method	Judgment	Instrument
			Daily	Interval				
				1 year	2 years			
Cooling system	Cooling fan	(1) Abnormal vibration and noise	○			(1) Turn the fan without applying voltage.	(1) Must be able to turn smoothly. (2) Must be free of abnormalities.	
		(2) Loose connection		○		(2) Tighten loose screws and bolts.		
Display	Display unit	(1) LEDs (2) Cleaning	○	○		(1) Check the LEDs on the panel. (2) Clean with rag.	(1) Make sure that the LEDs are lit.	
	Meter	Indication	○			(1) Check the indication of the meter on the panel.	(1) The indication must conform to the specified value.	Voltmeter, ammeter
Motor	Overall inspection	(1) Abnormal vibration and noise (2) Abnormal smell	○ ○			(1) Visual inspection, inspection by body feeling (vibration) and by ear. (2) Smell due to overheating, damage, etc.	(1) (2) Must be free of abnormalities.	
	Insulation resistance	Check with Megger (across terminals and ground terminal)			○	(1) Disconnect wires from the U, V, and W terminals. Motor wires should be included.	(1) Must be higher than 5M $\Omega$ .	500V Megger.

**Note:** The value for the 400V class is indicated in the parentheses.

## 23. INSPECTION AND MAINTENANCE

### 23.3 Replacing Parts

The inverter consists of a number of electronic component parts such as semiconductor devices. Due to their physical properties, it is anticipated that the following component parts will deteriorate with time, leading to troubles or lowered performance of the inverter. They should be replaced at regular intervals for preventive maintenance.

#### (1) Cooling fan

A cooling fan is used to cool heat generating parts such as semiconductor devices in the main circuit. Although the service life of the bearing used in the cooling fan is, under normal operating conditions, 20,000 hours, it will vary in the range of 10,000 to 35,000 hours depending on ambient temperatures.

Therefore, if the system is continuously operated, it is necessary to replace the cooling fan assembly every two to three years. Beside this regular replacement, if abnormal noise or vibration is detected during inspection, the cooling fan assembly should be replaced immediately.

#### (2) Smoothing capacitor

A large capacity aluminum electrolytic capacitor for smoothing the current is used in the direct current circuit in the main circuit. The performance of the capacitor is degraded due to the influence of ripple, etc. Although the service life of the capacitor varies depending on the ambient temperatures and operating conditions, the capacitor should be replaced every five years assuming that the parameter unit is used within specified environmental limits.

Since the deterioration of a capacitor accelerates over time, it should be checked at least once a year. As it approaches the end of service life, it should be checked every six months or at shorter intervals. The inspection items and defects which require the capacitor to be replaced are summarized below.

- 1) Case conditions: Expansion of the case at the side and bottom
- 2) Sealing conditions: Excessive curvature or cracks
- 3) Safety valve conditions: Excessive expansion of the valve or an actuated valve
- 4) Others:

Check for cracks, discoloration, leakage, or other defects. Measure the capacity. If measured capacity is less than 85% of rated, the capacitor should be replaced.

#### (3) Relays

Relay contacts deteriorate with use. Relays should be replaced according to the total number of make/break operations (service life).

#### (4) Replacement criteria

The following table shows the part replacement intervals. In addition to the parts given in this table, lamps and other component parts having shorter service life should be inspected at regular intervals.

Part name	Typical replacement intervals	Replacement procedure
Cooling fan	2 to 3 years	Replace on evidence of deterioration
Smoothing capacitor	5 years	
Relays	—	

## 23. INSPECTION AND MAINTENANCE

### 23.4 Measuring Voltage, Current, and Power in Main Circuit

#### ● Measuring the voltage and current

Since the inverter input/output voltage and current include high harmonic components, measurement results vary depending on the measuring instrument and the circuits used in measurement. To measure voltage and current with an instrument for commercial frequency application, use the instrument in the table given in the next page and the circuit in the following diagram.

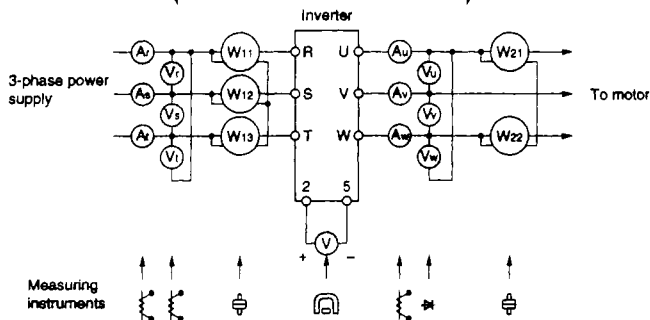
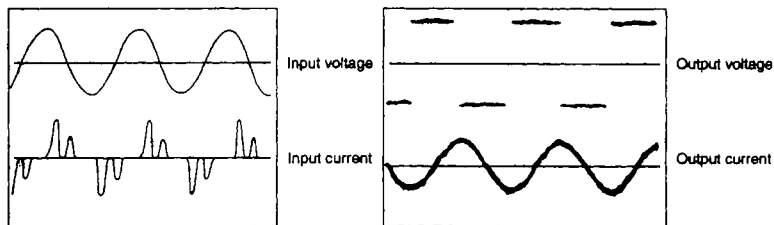

Measuring points and instruments



## 23. INSPECTION AND MAINTENANCE

### • Measuring points and instruments

Item	Measuring point	Instrument	Remark (criteria of measured value)*
Line voltage $V_1$	Across R and S, S and T, and T and R.	Moving-iron type voltmeter	Commercial voltage 170 to 253V 50/60Hz (323 to 506V)
Input current $I_1$	Line current at R, S, and T	Moving-iron type ammeter	
Input power $P_1$	On R, S, and T, and across R and S, S and T, and T and R	Electrodynamic type single-phase wattmeter	$P_1 = W_{11} + W_{12} + W_{13}$ (three wattmeter method)
Input power factor $Pf_1$	To be calculated using the formula indicated below, from the line voltage, input current and input power. $Pf_1 = \frac{P_1}{\sqrt{3} V_1 \times I_1} \times 100 \%$		
Output voltage $V_2$	Across U and V, V and W, and W and U	Rectifier type voltmeter (*1) (moving iron type is not acceptable.)	Difference between phases should be $\pm 1\%$ or less of the maximum output voltage. (When carrier frequency is 1 kHz)
Output current $I_2$	Line current at U, V, and W	Moving-iron type ammeter	Current should be equal to or less than the inverter rated current. Difference between phases should be 10% or less.
Output power $P_2$	On U, V, and W, and across U and V, V and W	Electrodynamic type single-phase wattmeter	$P_2 = W_{21} + W_{22}$ (two wattmeter method (or three wattmeter method))
Output power factor $Pf_2$	To be calculated using the formula indicated below, from the line voltage, input current and input power in the same manner as calculating input power factor. $Pf_2 = \frac{P_2}{\sqrt{3} V_2 \times I_2} \times 100 \%$		
Converter output	Across P(+) and N		Unit LED display lights $1.35 \times V_1$ Max. 380 VDC (760V) during regeneration.

## 23. INSPECTION AND MAINTENANCE

Item	Measuring point	Instrument	Remark (criteria of measured value)*									
Frequency setting signal	Across 2 (+) and 5	Moving coil type (multimeter, etc.) (internal resistance: 50 kΩ or larger)	0 to 5/0 to 10 VDC									
	Across 4 (+) and 5		4 to 20mADC									
Power supply for frequency setting	Across 10 (+) and 5		5 VDC	"5" for common								
Frequency meter signal	Across FM (+) and SD		Approx. 7 VDC at the maximum frequency (without frequency meter)	"SD" for common								
Start signal Selecting signal	Across STF, STR, RH, RL/OH, RM/RT, RM/AU and SD		20 to 30 VDC when opened 1 VDC or lower when closed (ON)									
Reset signal	Across RES (+) and SD											
Output stop signal	Across MRS/RT (+) and SD											
Error signal	Across A and C, and B and C	Moving coil type (multimeter, etc.)	Continuity checking <table style="width: 100%; border: none;"> <tr> <td></td> <td style="text-align: center;">&lt;Normal&gt;</td> <td style="text-align: center;">&lt;Error&gt;</td> </tr> <tr> <td>Across A and C</td> <td style="text-align: center;">Opened</td> <td style="text-align: center;">Closed</td> </tr> <tr> <td>Across B and C</td> <td style="text-align: center;">Closed</td> <td style="text-align: center;">Opened</td> </tr> </table>		<Normal>	<Error>	Across A and C	Opened	Closed	Across B and C	Closed	Opened
	<Normal>	<Error>										
Across A and C	Opened	Closed										
Across B and C	Closed	Opened										

\*1: A tester must not be used since error is excessive.

\*Values in parentheses indicate those for 400V class.

## 24. TROUBLESHOOTING

If a fault occurs and the inverter fails to operate properly, locate the cause of the fault and take proper corrective action by referring to the troubleshooting below. If the corresponding information is not found in the table, the inverter has problem, or the component parts are damaged, contact the nearest service representative.

### 24.1 Inspection by the Display on the Parameter Unit

In response to the occurrence of a fault, the display unit of the inverter automatically displays the code of the detected fault.

Display	Probable cause	Check	Corrective action
Err: Error	<ul style="list-style-type: none"> <li>• Operation setting error</li> <li>• Reset signal is ON.</li> <li>• PU is not connected to the inverter correctly.</li> <li>• High input voltage (approx. 260 VAC 520 VAC)</li> <li>• Faulty internal circuit</li> <li>• CPU run-away</li> </ul>	<ul style="list-style-type: none"> <li>• Review the operation method.</li> <li>• Is wiring at the reset terminal correct?</li> <li>• Is connector secured correctly?</li> <li>• Is input voltage correct?</li> </ul>	<ul style="list-style-type: none"> <li>• Reset the inverter (page 48).</li> <li>• Turn OFF the reset signal.</li> <li>• Correct the connection.</li> <li>• Use correct input voltage.</li> <li>• Change the inverter.</li> </ul>
OC1: Overcurrent during acceleration	Overcurrent	<ul style="list-style-type: none"> <li>• Is acceleration too fast?</li> <li>• Is output short-circuited or grounded?</li> </ul>	<ul style="list-style-type: none"> <li>• Extend acceleration time.</li> </ul>
OC2: Overcurrent during constant speed operation		<ul style="list-style-type: none"> <li>• Was load changed suddenly?</li> <li>• Is output short-circuited or grounded?</li> </ul>	<ul style="list-style-type: none"> <li>• Eliminate sudden load change.</li> </ul>
OC3: Overcurrent during deceleration		<ul style="list-style-type: none"> <li>• Is deceleration too fast?</li> <li>• Is output short-circuited or grounded?</li> <li>• Is mechanical brake applied too early?</li> </ul>	<ul style="list-style-type: none"> <li>• Extend deceleration time.</li> <li>• Check the brake application timing.</li> </ul>
OV1: Overvoltage during acceleration	DC overvoltage in main circuit	<ul style="list-style-type: none"> <li>• Is acceleration too fast?</li> </ul>	<ul style="list-style-type: none"> <li>• Extend acceleration time.</li> </ul>
OV2: Overvoltage during constant speed operation		<ul style="list-style-type: none"> <li>• Is load changed suddenly?</li> </ul>	<ul style="list-style-type: none"> <li>• Eliminate sudden load change.</li> </ul>
OV3: Overvoltage during deceleration		<ul style="list-style-type: none"> <li>• Is deceleration too fast?</li> </ul>	<ul style="list-style-type: none"> <li>• Extend deceleration time. (adjust deceleration time compensating for load <math>GD^2</math>) Reduce braking frequency.</li> </ul>

## 24. TROUBLESHOOTING

Display	Probable cause	Check	Corrective action
THT: Overload warning	Thermal relay for inverter is tripped.	<ul style="list-style-type: none"> <li>• Is motor used in the overloaded condition?</li> </ul>	<ul style="list-style-type: none"> <li>• Reduce the load.</li> <li>• Increase the capacity of motor and inverter.</li> </ul>
THM: Overload warning	Thermal relay for motor is tripped.		
FAN: Fan alarm	Cooling fan of the inverter has stopped.	<ul style="list-style-type: none"> <li>• Is there foreign matter inside the fan assembly?</li> <li>• Is there wiring error?</li> </ul>	<ul style="list-style-type: none"> <li>• Remove foreign matter.</li> <li>• Check the wiring.</li> </ul>
OLT: Stall prevention	Operation of the stall prevention function or the current limit function for a long period.	<ul style="list-style-type: none"> <li>• Is motor used in the overloaded condition?</li> </ul>	<ul style="list-style-type: none"> <li>• Reduce the load.</li> <li>• Increase the capacity of motor and inverter.</li> </ul>
BE: Brake transistor alarm (*1)	Faulty brake transistor	<ul style="list-style-type: none"> <li>• Is braking frequency correct?</li> </ul>	<ul style="list-style-type: none"> <li>• Reduce load (GD<sup>2</sup>).</li> <li>• Reduce braking frequency.</li> </ul>
OHT: External thermal relay tripped	An external thermal relay has been tripped.	<ul style="list-style-type: none"> <li>• Is the motor overheated?</li> <li>• Is an external relay in use?</li> </ul>	<ul style="list-style-type: none"> <li>• Reduce load (GD<sup>2</sup>).</li> <li>• Reduce braking frequency. Eliminate sending.</li> </ul>
PE: Parameter storing device error	Faulty EEPROM	<ul style="list-style-type: none"> <li>• Is the number of parameter writing too many?</li> <li>• Is EEPROM worn out?</li> </ul>	<ul style="list-style-type: none"> <li>• Replace the inverter.</li> </ul>
PUE: PU disconnection detected	Connector of the parameter unit is disconnected.	<ul style="list-style-type: none"> <li>• Is the parameter unit connection loose?</li> </ul>	<ul style="list-style-type: none"> <li>• Install and connect the parameter unit securely.</li> </ul>
rET: Retry count over	If operation cannot be resumed within the number of retry times set the inverter alarms and stop retry attempts.	<ul style="list-style-type: none"> <li>• Check the cause of the error</li> </ul>	
CPU: CPU error	CPU run-away The connection of the option and inverter is incorrect.	<ul style="list-style-type: none"> <li>• Is the connector section loose?</li> </ul>	<ul style="list-style-type: none"> <li>• Replace the inverter.</li> <li>• Securely connect.</li> </ul>
GF: Ground fault overcurrent (*2)	Occurrence of ground fault on output side	<ul style="list-style-type: none"> <li>• Is there a ground fault in the motor or wire?</li> </ul>	<ul style="list-style-type: none"> <li>• Repair the ground fault section.</li> </ul>
OPT: Option alarm	Times of communication retries are over or check time intervals is over	<ul style="list-style-type: none"> <li>• Check communication data and check time interval</li> </ul>	<ul style="list-style-type: none"> <li>• Correct communication data</li> </ul>
0: Stop key function	PU stop key pressed while Pr.75 = 14 to 17.	<ul style="list-style-type: none"> <li>• Pr.75 value</li> </ul>	<ul style="list-style-type: none"> <li>• Change setting.</li> </ul>

**Notes:** 1. \*1. For the inverter equipped with the optional brake resistor.  
\*2. Mounted on the 400 V class.

2. Error output is not given if input voltage is low or momentary power interruption occurs. In these cases, however, the inverter is protected so that the inverter will not be damaged. Depending on the operating status (magnitude of load, during acceleration/deceleration, etc.), the overcurrent protection function, etc. may be actuated when the input power is restored.

## 24. TROUBLESHOOTING

### 24.2 Troubles and Check Points

Trouble	Check points
Motor does not start.	(1) Check the main circuit. <ul style="list-style-type: none"> <li>• Is power supplied? (Is the POWER indicating lamp lit?)</li> <li>• Is the motor connected correctly?</li> </ul> (2) Check the input signals. <ul style="list-style-type: none"> <li>• Is the start signal input?</li> <li>• Are both the forward and reverse rotation signals input?</li> <li>• Is the frequency set signal zero?</li> <li>• Is the circuit across terminals AU and SD closed (ON) when the frequency setting signal is in the range from 4 to 20mA?</li> <li>• Is the output stop signal (across terminals MRS and SD) or the reset signal (across terminals RES and SD) ON?</li> </ul> (3) Check the values set for parameters. <ul style="list-style-type: none"> <li>• Is the reverse rotation prevention (Pr.78) function set?</li> <li>• Is the setting for the reverse mode (Pr.79) correct?</li> <li>• Are the setting for the bias and gain (Pr.902 to Pr.905) correct?</li> <li>• Is the setting for the start frequency (Pr.13) larger than the operation frequency?</li> <li>• Is the frequency setting for the operation functions (multiple-speed operation, etc.) correct?</li> <li>• Is the setting for the upper limit frequency (Pr.1) zero?</li> </ul> (4) Check the load. <ul style="list-style-type: none"> <li>• Is the load too heavy?</li> <li>• Is the motor start constrained?</li> </ul> (5) Others <ul style="list-style-type: none"> <li>• Has the emergency stop status been established by pressing the parameter unit stop key? (Is "E 0" displayed?)</li> <li>• Is the alarm indicating lamp (ALARM) lit?</li> </ul>
Motor rotates in the opposite direction.	<ul style="list-style-type: none"> <li>• Is the phase sequence (U, V, W) at the output terminals correct?</li> <li>• Are the start signals (forward, reverse) connected correctly?</li> </ul>
Actual motor speed differs from the set speed excessively.	<ul style="list-style-type: none"> <li>• Is the frequency setting signal correct? (Measure the input signal level.)</li> <li>• Are the values set for the following parameters correct? Pr.1 (upper limit frequency), Pr.38 (frequency at 5 VDC input), Pr.39 (frequency at 20mA input), Pr.902 to Pr.905 (bias and gain)</li> <li>• Are the input signal lines influenced by external noise? (use shielded wires, if influenced.)</li> </ul>
Motor acceleration or deceleration is not smooth.	<ul style="list-style-type: none"> <li>• Is acceleration or deceleration time too short?</li> <li>• Is the load too heavy?</li> <li>• Is the stall prevention function activated due to excessively large value set for torque boost?</li> </ul>
Motor speed varies during rotation.	<ul style="list-style-type: none"> <li>• Is the load changing?</li> <li>• Is the frequency setting signal stable?</li> </ul>
Motor current is too large.	<ul style="list-style-type: none"> <li>• Is the load too heavy?</li> <li>• Is the value set for torque boost (manual) too large?</li> </ul>

## 24. TROUBLESHOOTING

Trouble	Check points
Motor speed does not increase.	<ul style="list-style-type: none"><li>• Is the value set for upper limit frequency correct? Is it too small?</li><li>• Is the load too heavy?</li><li>• Is the stall prevention function activated due to excessively large value set for torque boost?</li></ul>
Motor speed fluctuates during motor operation.	<ol style="list-style-type: none"><li>(1) Check the load<ul style="list-style-type: none"><li>• Is the load changing?</li></ul></li><li>(2) Check the input signals.<ul style="list-style-type: none"><li>• Is the frequency setting signal stable?</li></ul></li><li>(3) Others<ul style="list-style-type: none"><li>• In the general-purpose magnetic flux vector control mode, is the setting for applicable motor capacity (Pr.80) correct for the inverter capacity and motor capacity?</li><li>• In the general-purpose magnetic flux vector control mode, is the wiring length longer than 30m (98.46 feet)?</li><li>• In the V/F control mode, is the wiring length too long?</li></ul></li></ol>

**Note:** "Pr." is an abbreviation of "Parameter."

## 24. TROUBLESHOOTING

### 24.3 Protection Functions

The following protection functions are provided to protect the inverter. If any of the protection functions is activated, the inverter output is shut off, the error message is displayed, and at the same time the error signal is output. In this case, the drive output is halted and the motor is free to rotate. To restart operation, it is necessary to reset the inverter.

Function Name		Description	Display (Parameter Unit)
Overcurrent shut-off		If the inverter output current exceeds 200% of the rated current during acceleration/deceleration or constant speed operation, the protection circuit is actuated and inverter output is shut off.	During acceleration <i>E.OC1</i> (OC1)
			During constant speed operation <i>E.OC2</i> (OC2)
			During deceleration <i>E.OC3</i> (OC3)
Regenerative overvoltage shut-off		If the DC voltage in the main circuit exceeds the specified value due to regenerative energy during braking, the protection circuit is activated and inverter output is shut off.	During acceleration <i>E.Ov1</i> (OV1)
			During constant speed operation <i>E.Ov2</i> (OV2)
			During deceleration <i>E.Ov3</i> (OV3)
Overload shut-off (electronic thermal relay) (*1)	Motor	If overheating of the motor due to overload or lowered cooling performance during low speed operation is sensed by the electronic thermal relay built in the inverter, the inverter output is shut off. To operate a multiple-pole motor or more than one motor, provide a thermal relay on the output side of the inverter for each motor.	<i>E.THM</i> (THM)
	Inverter	If the current exceeds 150% of the rated output current, but lower than 200% (overcurrent shut-off level), the electronic thermal relay is activated due to inverse time characteristics to shut off the inverter output, thereby protecting the output transistors.	<i>E.THT</i> (THT)
External thermal relay input (*2)		If the motor overheat protection thermal relay, installed externally, or the thermal relay built in the motor is activated (contact break), the inverter output is shut off. In this case, the inverter does not restart even if the relay contact closes automatically unless the inverter is reset.	<i>E.OHT</i> (OHT)
Brake transistor error detection (*3)		If an error of the brake transistor occurs due to excessively large regeneration energy (optional brake resistor connected), the function detects the error and shuts of the inverter output.	<i>E.bE</i> (BE)
Parameter error		The error signal is output and the inverter output is shut off. If an EEPROM error is detected.	<i>E.PE</i> (PE)
Parameter unit disconnection		If communications between the parameter unit and the inverter is suspended due to disconnection of the parameter unit from the inverter while the setting for Pr.75 is 2, 3, 16 or 17, the inverter output is shut off.	<i>E.PUE</i> (PUE)
Retry count over		If the operation cannot be Co-restarted within the preset number of retries, the inverter output is shut off.	<i>E.rEF</i> (RET)

## 24. TROUBLESHOOTING

Function Name		Description	Display (Parameter unit)
CPU error		If the cycle of the CPU is not completed within the set time, the self-diagnostics interprets this as an error and shuts off inverter output.	<i>E.CPU</i> (CPU)
Current limit stall prevention	During acceleration	If current exceeding 150% (*4) of the rated inverter current flows in the motor, frequency ramp is halted until load current is reduced to prevent overcurrent shut-off the inverter. If the load current is reduced to 150%, the frequency will increase again.	Indicating lamp of the monitor mode blinks
	During constant speed operation	If current exceeding 150% (*4) of the rated inverter current flows in the motor, frequency ramp is halted until load current is reduced to prevent overcurrent shut-off of the inverter. If the load current is reduced to 150%, the frequency will increase again.	Indicating lamp of the monitor mode blinks After the stop, <i>E.OLT</i> (OLT)
	During deceleration	If the motor regeneration energy increases excessively and exceeds brake performance, this function stops decreasing of the frequency to prevent overvoltage shut-off. Deceleration continues after the regeneration energy has been reduced. If current exceeding 150% (*4) of the rated inverter current flows in the motor, frequency decrease is halted until load current is reduced to prevent overcurrent shut-off of the inverter. If the load current is reduced to 150%, the frequency will decrease again.	Indicating lamp of the monitor mode blinks.
Ground Fault		If a ground fault current has flown due to a ground fault occurring in the output (load) side of the inverter, this function stops the inverter output. A ground fault occurring at low ground resistance may activate the overcurrent protection (OC1 to OC3). (Provided for the 400V type only.)	<i>E.GF</i> (GF)
Fan failure		When the cooling fan of the inverter has stopped due to a foreign matter stuck in the fan or malfunction, the inverter output will be ceased. (1.5K to 3.7K 200V, 2.2K, 3.7K 400V)	<i>E.FAN</i> (FAN)
Option alarm		Using computer communication, if times of communication retries are exceeded or check time interval is exceeded, the inverter output is shut off.	<i>E.OPF</i> (OPT)



## 24. TROUBLESHOOTING

---

**Notes:** \*1. If the inverter is reset, the accumulated internal thermal data of the electronic thermal relay is initialized. If "0" is set for Pr.9 (electronic thermal relay), the motor overload shut-off prevention function (THM) is invalid.

\*2. This function is valid only when the "external thermal relay" is set.

\*3. The function is valid only when the optional brake resistor is connected. (Brake resistor cannot be used for 0.1k and 0.2k. These drives have no brake transistor.)

\*4. The stall prevention function activation current level can be set as required. Factory-setting is 150%.

- Retaining the error output signal..... If the power input to the inverter power supply side, is opened, when the protection function is activated, the inverter control power supply is lost and the error output signal cannot be retained. If the error output signal must be retained, the drive wiring must be designed to retain the error output signal externally. See the block diagram for information.
- Error display ..... If the protection function is activated, the alarm (ALARM) indicating lamp is lit. In response to the operation of the parameter unit, the display unit gives the indication shown above.
- Resetting procedure ..... If the protection function is activated, the inverter output shut-off state is retained. Continued operation is impossible unless the inverter is reset. The inverter reset procedure is indicated in page 48.

## 24. TROUBLESHOOTING

### 24.4 Noise

There are two types of noises-external noises which cause malfunctioning of the inverter and those radiated from the inverter to cause malfunctioning of a peripheral device. Although the inverters are designed not to be influenced by noises, the following general measures must be taken since the inverter is an electronic device which handles weak signals. In addition, since the inverter chops the output by high carrier frequency, the inverter itself is a source of noise generation. If peripheral equipment is affected by the noise generated by the inverter, noise suppressing measures must also be taken. The noise suppressing measures differ depending on noise propagation route.

#### (1) General measures

- Avoid running the power cable (input/output lines) and the signal lines in parallel or bundling them.
- Use shielded twisted-wire pair cable for the connecting line to the encoder and the control signal lines. The sheathing of the shielded cable must be connected to terminal SD.
- Grounding must be single-point grounding for the inverter and the motor.

#### (2) External noise can cause malfunctioning of the inverter

If noise generating equipment (magnetic contactor, electromagnetic brake, a number of relays, etc.) is installed near the inverter, and if the inverter could malfunction due to the noise generated by such equipment, it is necessary to take the measures indicated below.

- To install a surge suppressor in the equipment which generates noises to suppress noises.
- To install a data line filter in the signal lines.
- Ground the line connecting to the encoder and the shield of the control signal lines with the metallic cable clamp.

#### (3) Noise radiated from the inverter that causes malfunctioning of peripheral devices

Noise generated by an inverter are largely classified into the following types-noise radiated from the wires connected to the inverter and the inverter main circuit (input/output), noise induced electromagnetically or electrostatically in the signal lines which is run close to the power cables of the main circuit, and noise which is transmitted through the power supply.

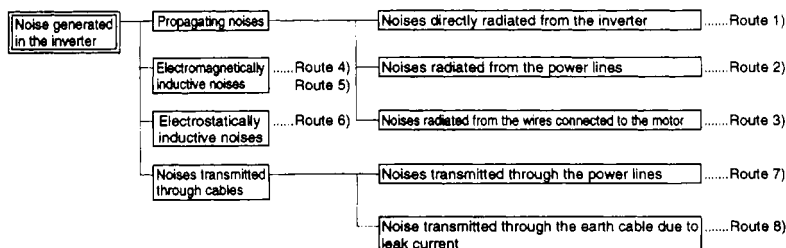

## 24. TROUBLESHOOTING

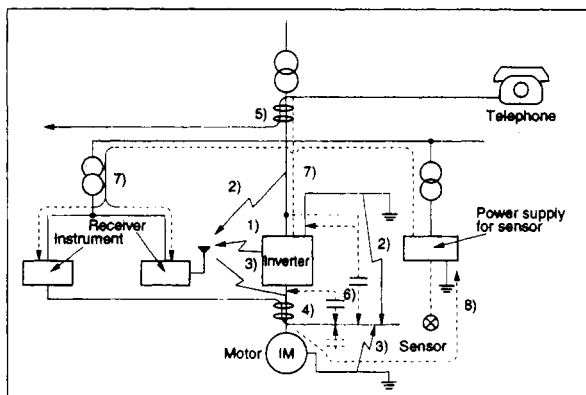

Noise Propagation/ Transmission Route	Measures
1) 2) 3)	<p>Equipment or devices such as measuring instruments, receivers, and sensors, which are noise susceptible, or those in which the signal lines are run in the same enclosure or close to the signal lines of the inverter, the equipment or devices may malfunction due to noise propagation. In such a case, it is necessary to take the following measures:</p> <ol style="list-style-type: none"> <li>(1) Install the equipment/devices which are easily influenced by noise away from the inverter.</li> <li>(2) Run the signal lines which are easily influenced by noise as far from the inverter and its input/output lines as possible.</li> <li>(3) Avoid running signal lines in parallel with the power lines (inverter input/output lines), also avoid bundling the signal lines with the power lines.</li> <li>(4) If a line noise filter or radio noise filter is connected in the input/output lines, radiated noise from the power line can be suppressed.</li> <li>(5) If shielded cables are used for signal lines and the power lines, or if the signal lines and the power lines are run in the individual metal conduits, the signal lines are effectively protected from propagated noises.</li> </ol>

## 24. TROUBLESHOOTING

Noise Propagation/ Transmission Route	Measures
4) 5) 6)	<p>If the signal lines are run in parallel to the power lines or if the signal lines are bundled with the power lines, noise (electromagnetically induced noise, electrostatically induced noise) may propagate to the signal lines causing malfunctioning. In such cases, it is necessary to take the following measures:</p> <ol style="list-style-type: none"><li>(1) Install the equipment/devices which are easily influenced by noise away from the inverter.</li><li>(2) Run the signal lines which are easily influenced by noise as far from the inverter and its input/output lines as possible.</li><li>(3) Avoid running signal lines parallel with the power lines (inverter input/output lines), also avoid bundling the signal lines with the power lines.</li><li>(4) If shielded cables are used for signal lines and the power lines, or if the signal lines and the power lines are run in the individual metal conduits, the signal lines are effectively protected from propagation of noise.</li></ol>
7)	<p>If peripheral device is connected to the same power supply where the inverter is connected, noise generated by the inverter may be transmitted to the peripheral device through the power lines causing malfunctioning of the peripheral device. In such a case, it is necessary to take the following measures:</p> <ol style="list-style-type: none"><li>(1) Install a radio noise filter (FR-BIF(-H)) in the power line (input lines) of the inverter.</li><li>(2) Install a line noise filter (FR-BSF01) in the power line (input/output lines) of the inverter.</li></ol>
8)	<p>If a closed loop circuit is formed due to the wiring of a peripheral device to the inverter, leakage current may flow into the peripheral device through the grounding cable of the inverter and cause malfunctioning of the peripheral equipment. If this occurs, disconnect the grounding cable of the peripheral device.</p>

# 24. TROUBLESHOOTING

## • Examples and Results of Noise Protection

It is possible to lower the interference voltage(\*) by lowering the carrier frequency. If motor noise does not pose a critical problem, lower the carrier frequency (1kHz) by changing the setting for Pr.72.

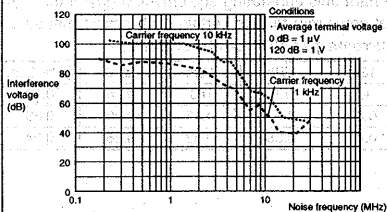

It is possible to reduce induced noises remarkably (1/10 to 1/100) by using shielded cable for the signal lines.

Running the signal line apart from inverter output line is also effective to reduce induced noise (reduction 1/2 to 1/3 by running the signal line 30cm apart from the inverter output line).

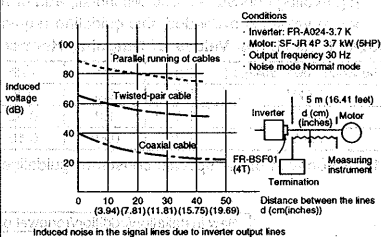

\*Interference voltage: Represents amplitude of noise transmitted to the power supply from the inverter.

## • Noise protection measures

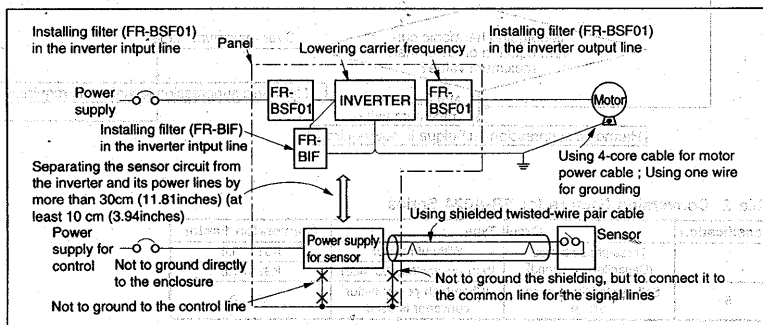

## 24. TROUBLESHOOTING

### 24.5 Power harmonic guidelines (Japan)

Harmonic currents generated by the inverter flow to a power receiving point via a power transformer. Since these outgoing harmonic currents affect other consumers, the power harmonic suppression guidelines were established.

1) "Household appliance and general-purpose product guideline"

200V class inverters of 3.7kW and less are covered by this guideline. Install a power factor improving reactor to comply with this guideline.

2) "Specific consumer guideline"

This guideline sets forth the maximum values of harmonic currents outgoing from a high-voltage or very high-voltage consumer who will install, add or renew harmonic generating equipment. If any of the maximum values is exceeded, this guideline requires that consumer to take certain suppression measures.

**Table 1 Maximum Values of Outgoing Harmonic Currents per 1kW Contract Power**

Received Power Voltage	5th	7th	11th	13th	17th	19th	23rd	Over 23rd
6.6kV	3.5	2.5	1.6	1.3	1.0	0.9	0.76	0.70
22kV	1.8	1.3	0.82	0.69	0.53	0.47	0.39	0.36
33kV	1.2	0.86	0.55	0.46	0.35	0.32	0.26	0.24

(1) Application of the specific consumer guideline

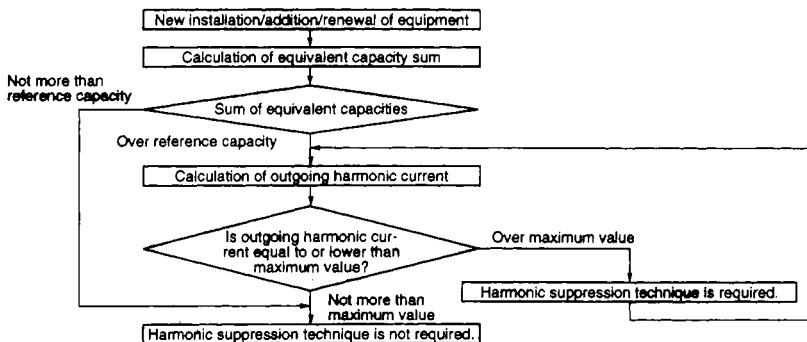

**Table 2 Conversion Factors for FR-A024 Series**

Classification	Circuit Type		Conversion Factor
3	Three-phase bridge (Capacitor smoothed)	Without reactor	K31 = 3.4
		With reactor (on AC side)	K32 = 1.8
5	Self-excited three-phase bridge	When high power factor converter is used	K5 = 0

**Table 3 Equivalent Capacity Limits**

Received Power Voltage	Reference Capacity
6.6kV	50kVA
22/33kV	300kVA
66kV or more	2000kVA

**Table 4 Harmonic Content (Values at the fundamental current of 100%)**

Reactor	5th	7th	11th	13th	17th	19th	23rd	25th
Not used	65	41	8.5	7.7	4.3	3.1	2.6	1.8
Used (AC side)	38	14.5	7.4	3.4	3.2	1.9	1.7	1.3

## 24. TROUBLESHOOTING

### 1) Calculation of equivalent capacity P0 of harmonic generating equipment

The "equivalent capacity" is the capacity of a 6-pulse converter converted from the capacity of a consumer's harmonic generating equipment and is calculated with the following equation. If the sum of equivalent capacities is higher than the limit in Table 3, harmonics must be calculated with the following procedure:

$$P_0 = \sum (K_i \times P_i) \text{ [kVA]}$$

K<sub>i</sub>: Conversion factor (refer to Table 2)

P<sub>i</sub>: Rated capacity of harmonic generating equipment\* [kVA]

i: Number of indicating the conversion circuit type

**Rated capacity:** Determined by the capacity of the applied motor and found in Table 5. It should be noted that the rated capacity used here is used to calculate generated harmonic amount and is different from the power supply capacity required for actual inverter drive.

### 2) Calculation of outgoing harmonic current

Outgoing harmonic current=fundamental wave current (value converted from received power voltage) × operation ratio × harmonic content

· Operation ratio: Operation ratio = actual load factor × operation time ratio during 30 minutes

· Harmonic content: Found in Table 4.

**Table 5 Rated Capacities and Outgoing Harmonic Currents for Inverter Drive**

Applied Motor (kW)	Rated Current [A]		Fundamental Wave Current Converted from 6.6kV (mA)	Rated Capacity (kVA)	Fundamental Wave Current Converted from 6.6kV (No reactor, 100% operation ratio)								
	200V	400V			5th	7th	11th	13th	17th	19th	23rd	25th	
0.1	Not Applied	—	—	—	—	—	—	—	—	—	—	—	—
0.2		—	—	—	—	—	—	—	—	—	—	—	—
0.4		0.81	49	0.57	31.85	20.09	4.165	3.773	2.107	1.519	1.274	0.882	
0.75		1.37	83	0.97	53.95	34.03	7.055	6.391	3.569	2.573	2.158	1.494	
1.5		2.75	167	1.95	108.6	68.47	14.20	22.86	7.181	5.177	4.342	3.006	
2.2		3.96	240	2.81	156.0	98.40	20.40	18.48	10.32	7.440	6.240	4.320	
3.7		6.50	394	4.61	257.1	161.5	33.49	30.34	16.94	12.21	10.24	7.092	

### 3) Harmonic suppression technique requirement

If the outgoing harmonic current is higher than the maximum value per 1kW contract power × contract power, a harmonic suppression technique is required.

### 4) Harmonic suppression techniques

No.	Item	Description
1	Reactor installation (ACL, DCL)	Install a reactor (ACL) in the AC side of the inverter or a reactor (DCL) in its DC side or both to suppress harmonic currents.
2	High power factor converter (FR-HC)	Designed to switch the converter circuit on-off to convert an input current waveform into a sine wave, the high power factor converter (FR-HC) suppresses harmonic current considerably. The FR-HC is used with the standard accessories.
3	Installation of power factor improving capacitor	When used with a series reactor, the power factor improving capacitor has an effect of absorbing harmonic currents.
4	Transformer multiphase operation	Use two transformers with a phase angle difference of 30 as in Y-Δ, Δ-Δ combination to provide an effect corresponding to 12 pulses, reducing low-degree harmonic currents.
5	AC filter	A capacitor and a reactor are used together to reduce impedance at specific frequencies, producing a great effect of absorbing harmonic currents.
6	Active filter	This filter detects the current of a circuit generating a harmonic current and generates a harmonic current equivalent to a difference between that current and a fundamental wave current to suppress a harmonic current at a detection point, providing a great effect of absorbing harmonic currents.

## 24. TROUBLESHOOTING

### Leakage Current

Between the input/output lines of the inverter and in the motor, capacitance exists and due to this capacitance leakage current flows. Since amount of leakage current varies depending on the capacitance and carrier frequency, leakage current will increase if low-noise operation is attempted by higher carrier frequency setting. It is necessary to take the measures indicated below if such operation mode is required.

#### (1) Leakage current to grounding

Leakage current not only flows into the circuits of the inverter itself, but it also flows into the circuits of other systems through the grounding.

##### ● Measures

- Lower the carrier frequency (Pr.72). If the carrier frequency is lowered, motor noise is increased.
- Use leakage breaker designed for higher harmonic and surge, New Super NV series of Mitsubishi for example. This allows low noise operation (at higher carrier frequency). For details of leak breaker selection, refer to page 128.

#### (2) Leakage current between the lines

There are cases that an external thermal relay is tripped unexpectedly due to higher harmonic component of the leakage current generated by the capacitance between the inverter output lines.

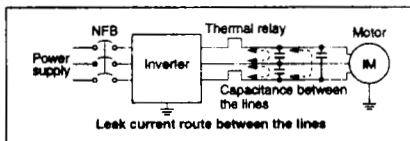

##### ● Measures

- Use an electronic thermal relay of the inverter.
- Lower the carrier frequency. This causes increased motor noise.  
To protect the motor correctly without being affected by the leakage current between the lines, the method to directly detect the motor sensor using a temperature sensor is recommended.

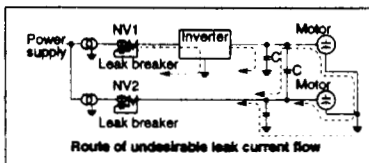



## 25. SPECIFICATIONS

### 25.1 Standard Specifications

#### ■ 200V Class

Type FR-A024- <input type="text"/>		0.1K	0.2K	0.4K	0.75K	1.5K	2.2K	3.7K
Applicable motor capacity *1	HP	1/8	1/4	1/2	1	2	3	5
	kW	0.1	0.2	0.4	0.75	1.5	2.2	3.7
Output	Rated capacity (kVA) *2	0.3	0.6	1.2	2	3.2	4.4	6.8
	Rated output current (A) *7	0.8 (0.8)	1.5 (1.4)	3 (2.5)	5 (4.1)	8 (7)	11 (10)	17.5 (16.5)
	Overload current rating *3	150% for 60 seconds, 200% for 0.5 seconds (reverse time characteristics)						
	Rated output voltage *4	3-phase, 200 to 230V						
Power supply	Rated input AC voltage	3-phase, 200 to 230 V 50/60Hz						
	AC voltage permissible fluctuation	180 to 253V 50/60Hz						
	Frequency permissible fluctuation	±5%						
	Power source capacity (kVA) *5	0.4	0.8	1.5	2.5	4.5	5.5	9
Protective construction (JEM1030)	Enclosed type (IP20) (Fully enclosed type IP40: semi-standard product)							
Cooling method	Self-cooling				Forced air cooling			
Show units for both entries (WATTS) and heat generation (inverter) *8	16 (23)	20 (30)	45 (55)	50 (70)	85 (120)	100 (150)	160 (240)	
Approximate weight (kg/lbs) *6	0.7/1.54	0.7/1.54	0.9/1.98	1.3/2.86	1.5/3.34	2.2/4.85	2.2/4.85	

#### ■ 400V Class

Type FR-A044- <input type="text"/>		0.4K	0.75K	1.5K	2.2K	3.7K
Applicable motor capacity *1	HP	1/2	1	2	3	5
	kW	0.4	0.75	1.5	2.2	3.7
Output	Rated capacity (kVA) *2	1.2	2	3.1	4.6	6.9
	Rated output current (A) *7	1.6 (1.4)	2.6 (2.2)	4 (3.8)	6 (5.4)	9 (8.7)
	Overload current rating *3	150% for 60 seconds, 200% for 0.5 seconds (reverse time characteristics)				
	Rated output voltage *4	3-phase, 380 to 460V				
Power source	Rated input AC voltage	3-phase, 380 to 460V 50/60Hz				
	AC voltage permissible fluctuation	323 to 506V 50/60Hz				
	Frequency permissible fluctuation	±5%				
	Power source capacity (kVA) *5	1.5	2.5	4.5	5.5	9
Protective construction (JEM1030)	Enclosed type (IP20)					
Cooling method	Self-cooling			Forced air cooling		
Show units for both entries (WATTS) and heat generation (inverter) *8	45 (55)	50 (70)	85 (120)	100 (150)	160 (240)	
Approximate weight (kg/lbs) *6	1.6/3.53	1.6/3.53	2.3/5.07	2.5/5.51	2.5/5.51	

## 25. SPECIFICATIONS

- Notes:**
- \*1: The values in the table indicate the maximum applicable capacity for Mitsubishi standard squirrel-cage type motor 4P. Generally, the rated current (at 50Hz) of the applicable motor should not exceed the rated output current.
  - \*2: The rated capacity indicated assumes that the output voltage is 220V for the 200V class and 440V for the 400V class.
  - \*3: The value (%) for rated overload current indicates the ratio to the rated output current of the inverter.
  - \*4: The output voltage cannot exceed the supply voltage.
  - \*5: The power supply capacity varies depending on the impedance of the power supply circuit (including reactor in the input circuit and power line). The power supply which has the capacity larger than the specified value is required.
  - \*6: The value indicates the inverter without a parameter unit. A parameter unit weighs approximately 0.1kg.(2.2lbs)
  - \*7: Rated output current in ( ) is for low-noise operation by setting 2kHz or higher carrier frequency for Pr.72 when ambient temperature is greater than 40 °C (104 °F)
  - \*8: The values in ( ) indicate the heat generation during low-noise operation (Pr.72=14.5kHz).

## 25. SPECIFICATIONS

### 25.2 Common Specifications

Control specifications	Control method		Selection from: Sinusoidal PWM control (high carrier frequency), V/F control, and general-purpose magnetic flux vector control	
	Output frequency		0.2 to 400Hz (starting frequency: 0 to 60Hz, variable)	
	Resolution for setting frequency	Digital input	0.01Hz (less than 100Hz), 0.1Hz (100Hz or higher), when set with a parameter unit	
		Analog input	1/500 of maximum frequency (5VDC input), 1/1000 of maximum frequency (10VDC or 4 to 20mA input)	
	Frequency accuracy	Digital setting	Within 0.01% of set output frequency (-10 °C (14 °F) to +50 °C (122 °F)), when set with a parameter unit	
		Analog setting	Within ±0.5% of the maximum output frequency (25 °C (77°F) ±10 °C (18 °F))	
	Voltage/frequency characteristics		Base frequency can be set as required in the range of 50 to 400Hz. Constant torque or variable torque pattern is selectable.	
	Starting torque		Higher than 200% (at 6Hz).....For Mitsubishi standard motor, 4P	
	Torque boost		Manual torque boost setting (0 to 30%) range	
	Acceleration/deceleration characteristics		0.04 seconds, 0.1 to 3600 seconds (individual setting for acceleration and deceleration) Linear or S-pattern mode is selectable.	
Braking torque	Regenerative braking (*9)	0.1K, 0.2K.....150% Min. 0.4K, 0.75K.....100% Min. 1.5K.....50% Min. 2.2K, 3.7K.....20% Min.		
	DC insection braking	Setting is possible for: Operation frequency (0 to 120Hz), actuation time (0 to 10 seconds), voltage (0 to 30%)		
Operation characteristics	Stall prevention function actuation level		Active for current levels (0 to 200%)	
	Frequency setting signal		0 to 5VDC, 0 to 10VDC, 4 to 20mADC	
	Input signals	Start signal		The forward run/reverse run independent start signal self-hold input (3-wire input) can be selected.
		Multiple-speed selection		Selection is possible for up to 15 speeds (frequency can be changed during operation with a parameter unit)
		Second acceleration/deceleration time selection		0.04 seconds, 0.1 to 3600 seconds (individual setting for acceleration and deceleration)
		Current input selection		Frequency reference current signal (4 to 20mA)
		External thermal relay input selection		Input of the external thermal relay tripped signal
		Output shutoff		Inverter output is shutoff.
Reset		Status, retained at the actuation of the protection function, is cleared.		

## 25. SPECIFICATIONS

Operation characteristics	Output signals	Operation status	Selection of two from: In-operation (RUN), Max frequency reach (SU), preset frequency reached (FU), overload (OL), and open motor circuit (OMD)	
		Error	Form	1 form c contact signal
		Monitor *10	For outputting to the analog meter (1 mA full scale) or digital meter (1440 Hz/60 Hz)	
Incorporated functions			Current limit, setting of upper and lower limit frequency, setting of gain and bias, electronic thermal relay for motor OL, selection of operation mode, selection of functions allocated to the terminals, setting the output signal activation point, selection of FM terminal output specification, setting the second functions (torque boost, base frequency, acceleration/deceleration time), calibrating the frequency meter, restart after momentary power interruption, correct the slip, retry after alarm, etc.	
Display	Parameter unit	Operation status	Output frequency, motor current (*11), set frequency, rotation direction	
		Alarm	Alarm code after the activation of protection functions, stores up to four events of alarm occurrence	
	LED display		Power on (POWER), protection function actuation (ALARM)	
Protection and warning functions			Overcurrent shutoff (during acceleration, fixed speed operation, and deceleration), regeneration overvoltage shutoff, overload shut off (electronic thermal relay), brake transistor alarm, low voltage (*12), momentary power interruption (*12), external thermal relay activation, stall prevention, ground fault overcurrent*14	
Environmental condition	Ambient	Temperature (*15)	-10 °C (14 °F) to + 50 °C (122 °F) (no freezing)	
		Humidity	90%RH or less (non condensation)	
	Storage temperature *13		-20 °C (-4 °F) to + 65 °C (149 °F)	
	Atmosphere		Indoor, must be free of corrosive gas, inflammable gas, oil mist, and dust	
	Altitude, vibration		Below 1000 m (3280.8 feet) above sea level, less than 5.9 m/sec <sup>2</sup> (0.6G) (conforms to JIS C0911.)	

## 25. SPECIFICATIONS

**Notes:** \*9: The magnitude of braking torque is not continuous regenerative torque. It is the short term average deceleration torque when an unloaded motor is decelerated from 60Hz in the shortest possible time. This value also varies with motor losses. The deceleration torque decreases beyond base frequency. Since this inverter is not equipped with a brake resistor, use the optional brake resistors from page 144 for applications where large magnitudes of regenerative energy must be dissipated.

CAUTION: A brake resistor may not be used on 0.1K and 0.2K units.

- \*10: It is possible to select output frequency or motor current monitor. Specify selection for output signals in Pr.54 using a parameter unit.
- \*11: Displays may not be accurate, depending on the operating status, during acceleration/deceleration, low-load operation, etc.
- \*12: In the case of low voltage or momentary power interruption, alarm is not displayed and no alarm signal is output. However, the inverter itself is protected. The overcurrent protection function or other protection functions may be activated when the power is restored based on the operating conditions (load, etc.)
- \*13: This temperature range is applicable during transportation.
- \*14: Only the FR-A044 (400 V class) functions.
- \*15: When using the fully closed specifications, this will be -10°C (14°F) to +40°C (104°F).

## 25. SPECIFICATIONS

### 25.3 Block Diagram

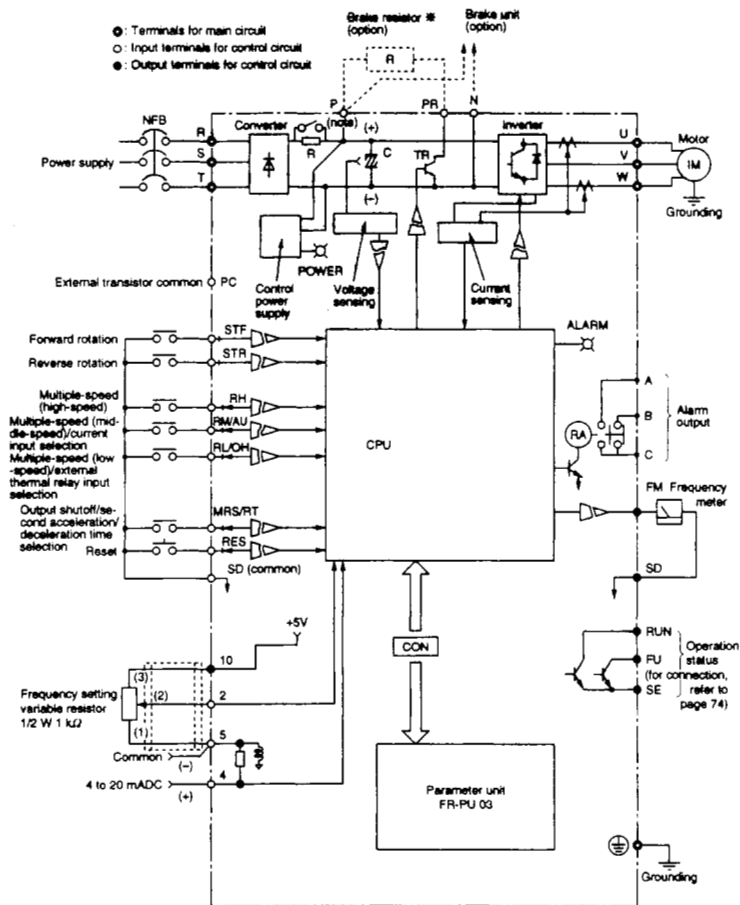

(Note) Equipped for FR-A024-2.2K, 3.7K and FR-A044-0.4K to 3.7K

\* Brake resistor cannot be used for FR-A024-0.1K and 0.2K.

## 25. SPECIFICATIONS

### 25.4 Definition of Terminals

	Symbol	Name	Description	
Main circuit	R. S. T	AC power supply input terminals	For incoming commercial power supply. Do not connect power supply when connecting FR-HC option unit.	
	U. V. W	Inverter output terminals	Output for a three-phase squirrel cage motor.	
	P. PR	Brake resistor terminals	For an optional brake resistor.	
	N	Brake unit terminal	For connecting an optional brake unit.	
		Grounding terminal	For grounding the inverter chassis. Ground to the earth.	
Control circuit (input signals)	STF	Forward rotation start signal input terminal	By closing the terminals STF and SD, the motor accelerates forward to the reference speed. The motor stops rotating when the circuit across the terminals is opened.	If circuits across STF and SD, STR and SD are closed simultaneously, it is regarded as the motor stop command.
	STR	Reverse rotation start signal input terminal	By closing the circuit across terminals STR and SD, the motor accelerates in reverse to the reference speed. The motor stops rotating when it is opened.	
	RH (Note)	Multiple-speed selection terminal (high-speed)	By the open and close state combinations of RH and SD, RM and SD, RL and SD, seven preset speeds may be referenced. RM is also used as the current input selection terminal (AU) and RL the external thermal relay signal input selection terminal (OH). Factory-setting is for multiple-speed selection. If AU and SD is closed, operation is possible using the 4 to 2 mA DC current frequency reference signal. If a contact point signal of an external thermal relay is input to OH and SD the inverter operation will stopped by tripping the thermal relay (contact break).	
	RM/AU (Note)	Multiple-speed selection terminal (middle-speed) Current input selection terminal		
	RL/OH (Note)	Multiple-speed selection terminal (low-speed) External thermal relay signal input selection terminal		
	MRS/RT (Note)	Output shutoff terminal Second acceleration/ deceleration selection terminal	Inverter output is halted by closing MRS and SD. This terminal is also used as the 2nd acceleration/deceleration time, 2nd torque boost and 2nd V/F selection terminal (RT). Factory-setting is for inverter output halt.	
	RES	Reset terminal	The terminal is used to release the protection function circuit activated state which is retained. After closing RES and SD for at least 0.1 seconds, open it, and fault condition will be reset.	
	SD	Control circuit common	The common terminal for contact input and display unit terminals. It is isolated from the common terminal of the reference circuit.	
	PC	External transistor common terminal	To connect the transistor output (open collector output) of a programmable controller, connect the external power supply common terminal for the transistor output to this terminal. This prevents malfunctioning of the inverter due to transistor leakage current.	
	10	Power supply terminal for frequency reference	5 VDC. Maximum permissible load current: 10 mA	

## 25. SPECIFICATIONS

	Symbol	Name	Description
Control circuit (input signals)	2	Frequency setting reference terminal (voltage signal)	In response to the input of 0 to 5 VDC (10 VDC), the maximum output frequency is obtained at 5 VDC (10 VDC). The output frequency obtained is proportional to the input voltage. Whether 5 V input or 10 V input is used is determined by the setting of Pr. 38 (refer to page 73). Input resistance: 10 k $\Omega$ Maximum permissible input voltage: 20 V
	5	Frequency reference common terminal	The common terminal for the frequency reference signals. It is not isolated from the common terminal of the control circuit. Do not ground to earth.
	4	Current input terminal (current signal)	Frequency reference current signal of 4 to 20 mA DC is input. Factory-default, gain and bias are adjusted to 0 Hz at 4 mA input and 60 Hz at 20 mA input. Input resistance: Approx. 250 $\Omega$ Maximum permissible input current: 30 mA
Control circuit (output signals)	A, B, C	Alarm output contact terminals	The contact output which indicates the inverter has been shut off due to the activation of the protection circuit. At an occurrence of alarm: B-C Open A-C Close During normal operation: B-C Close A-C Open Contact capacity: 230 VAC 0.3 A, 30 VDC 0.3 A
	RUN	Operating status output terminals	From the following five types of output specification, two can be selected (refer to page 74.) • RUN (during operation) L level: Above the starting frequency H level: Stopped, or DC injection brake operating • SU (frequency reached) L level: Output frequency higher than the set frequency. H level: Stopped, or during acceleration/deceleration • FU (frequency programmed has been reached) L level: Output frequency higher than the preset frequency level H level: Output frequency lower than the preset frequency level • OL (overload warning) L level: Stall prevention function is activated (current limit function). H level: Stall prevention function is released. • The open motor circuit detection (OHD) will be the L level when the output current during inverter operation is less than a set level, and will be the H level when above a set level. Open collector output Permissible load: 24 VDC, 0.1A
	FU		
	SE	Open collector common terminal	The common terminal for RUN and FU (emitter). It is isolated from the common terminal of the control circuit.
FM	Output frequency indicator connection terminal	Adjusted to output approx. 7 VAC at 60 Hz (factory-setting) when FM and SD is open. Output voltage is obtained in proportion to output frequency. Since the output is pulse train, connection of a digital counter is advisable. Pulse specification: 1440 Hz/60 Hz 8 V (refer to page 91.)	

**Note:** 1. For these terminals, which function should be allocated is selectable by Pr. 59 "Input terminal allocation" setting from 10 functions.  
The multiple-speed selection is given higher priority than analog frequency reference signal.



## 25. SPECIFICATIONS

### 25.5 External Dimensions

#### Standard specification

<200V class>

Mounting screw  
M4 (4 positions)

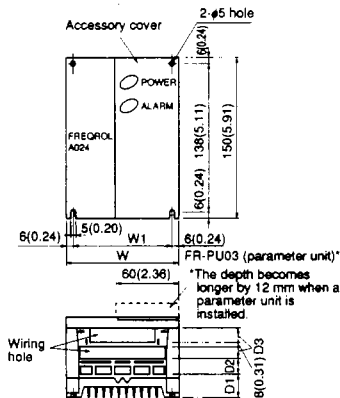

When a parameter unit is installed



Inverter type	mm (inches)						
	W	W1	D	D1	D2	D3	D4
FR-A024-0.1K	105 (4.13)	93 (3.66)	66 (2.60)	12 (0.47)	15 (0.59)	10.5 (0.41)	4 (0.16)
FR-A024-0.2K	105 (4.13)	93 (3.66)	76 (2.99)	22 (0.87)	15 (0.59)	10.5 (0.41)	5 (0.20)
FR-A024-0.4K	105 (4.13)	93 (3.66)	105 (4.13)	51 (2.01)	15 (0.59)	10.5 (0.41)	5 (0.20)
FR-A024-0.75K	105 (4.13)	93 (3.66)	105 (4.13)	51 (2.01)	15 (0.59)	10.5 (0.41)	5 (0.20)
FR-A024-1.5K	140 (5.51)	128 (5.04)	116 (4.57)	62 (2.44)	15 (0.59)	10.5 (0.41)	5 (0.20)
FR-A024-2.2K	200 (7.87)	188 (7.40)	126 (4.96)	61 (2.40)	25.5 (1.00)	10.5 (0.41)	5 (0.20)
FR-A024-3.7K	200 (7.87)	188 (7.40)	126 (4.96)	61 (2.40)	25.5 (1.00)	10.5 (0.41)	5 (0.20)

Notes 1: Type 0.75K, when compared with the FR-Z024 series, is shorter in width by 35 mm (1.38 inches) and longer in depth by 19 mm (0.75 inches).

2: FR-A024-1.5K to 3.7K are equipped with a cooling fan.

#### Fully enclosed specification

<200V class>

Mounting screw  
M4 (4 positions)

■ FR-A024-0.1K-C to 3.7K-C

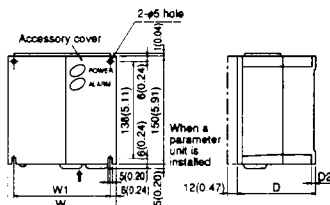

■ FR-A024-0.1K-C to 0.4K-C  
(View at the arrow)

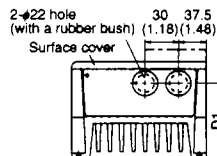

Inverter type	mm (inches)				
	W	W1	D	D1	D4
FR-A024-0.1K-C	105 (4.13)	93 (3.66)	66 (2.60)	42 (1.65)	4 (0.16)
FR-A024-0.2K-C	105 (4.13)	93 (3.66)	105 (4.13)	81 (3.19)	5 (0.20)
FR-A024-0.4K-C	140 (5.51)	128 (5.04)	116 (4.57)	92 (3.62)	5 (0.20)
FR-A024-0.75K-C	140 (5.51)	128 (5.04)	116 (4.57)	92 (3.62)	5 (0.20)
FR-A024-1.5K-C	200 (7.87)	188 (7.40)	126 (4.96)	102 (4.01)	5 (0.20)
FR-A024-2.2K-C	200 (7.87)	188 (7.40)	126 (4.96)	102 (4.01)	5 (0.20)
FR-A024-3.7K-C	200 (7.87)	188 (7.40)	126 (4.96)	102 (4.01)	5 (0.20)

\*1: FR-A024-0.75K to 3.7K-C are equipped a cooling fan.

\*2: Operating ambient temperature: -10 °C (14 °F) to +40 °C (104 °F)

■ FR-A024-0.75K-C to 3.7K-C  
(View at the arrow)

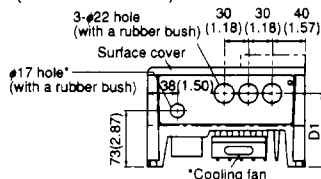

\* #17 hole applies to FR-A024-2.2K-C and FR-A024-3.7K-C only.

## 25. SPECIFICATIONS

### Standard specification

<400V class>

Mounting screw

M4 (4 positions)

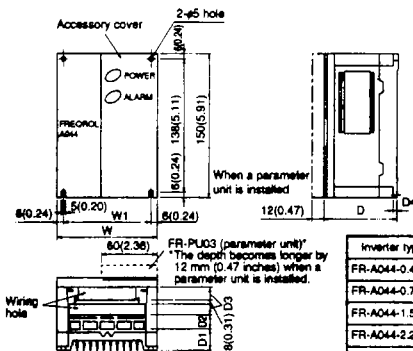

mm (inches)

Inverter type	W	W1	D	D1	D2	D3	D4
FR-A044-0.4K	140	128	116	22	15	10.5	5
FR-A044-0.75K	(5.51)	(5.04)	(4.57)	(0.87)	(0.59)	(0.41)	(0.20)
FR-A044-1.5K	200	188	136	71	25.5	10.5	5
FR-A044-2.2K	(7.87)	(7.40)	(5.35)	(2.80)	(1.00)	(0.41)	(0.20)
FR-A044-3.7K							

Note : FR-A044-2.2K to 3.7K are equipped with a cooling fan.

### Fully enclosed specification

<400V class>

mm (inches)

Mounting screw

M4 (4 positions)

■ FR-A044-0.4K-C to 3.7K-C

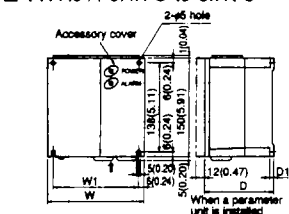

■ FR-A044-0.4K-C

(View at the arrow)

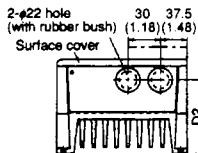

Inverter type	W	W1	D	D1	D2	G
FR-A044-0.4K-C	140	128	116	5	92	—
	(5.51)	(5.04)	(4.57)	(0.20)	(3.62)	
FR-A044-0.75K-C	200	188	136	5	112	34
	(7.87)	(7.40)	(5.35)	(0.20)	(4.48)	(1.36)
FR-A044-1.5K-C	200	188	136	5	112	34
	(7.87)	(7.40)	(5.35)	(0.20)	(4.48)	(1.36)
FR-A044-2.2K-C	200	188	136	5	112	34
	(7.87)	(7.40)	(5.35)	(0.20)	(4.48)	(1.36)
FR-A044-3.7K-C	200	188	136	5	112	34
	(7.87)	(7.40)	(5.35)	(0.20)	(4.48)	(1.36)

\*1: FR-A044-2.2K to 3.7K-C are equipped a cooling fan.

\*2: Operating ambient temperature: -10 °C (14 °F) to +40 °C (104 °F)

■ FR-A044-0.75K-C to 3.7K-C

(View at the arrow)

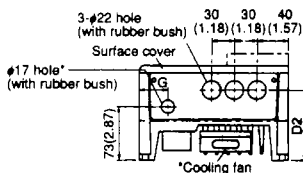

\* #17 hole applies to FR-A024-2.2K-C and FR-A024-3.7K-C only.

## 25. SPECIFICATIONS

### ● Parameter Unit

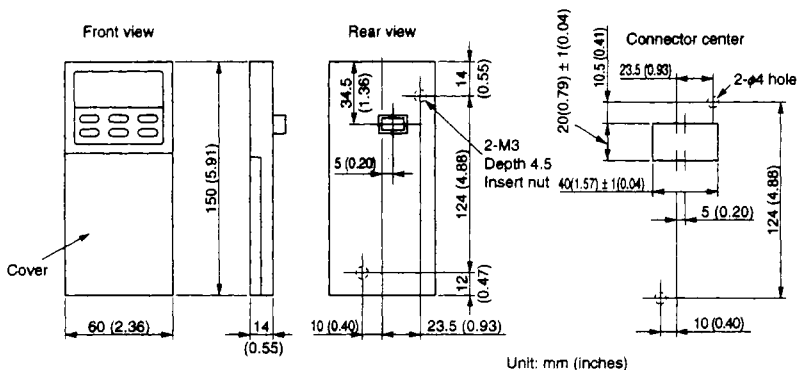

Item		Specification	
Ambient	Temperature	Operating temperature	-10 °C (14 °F) to +50 °C (122 °F)
		Storage temperature	-20 °C (-4 °F) to +65 °C (149 °F)
	Humidity	10% to 90% RH	To be free of condensing
Environment		To be free of oil mist and corrosive gas, and dense dust	
Cooling method		Self-cooling	
To be connected to		FR-A024 series inverter, or special cable (FR-CBL)	
Power supply		From inverter	
Connection		Direct installation to inverter or remote installation using a special cable	
Display		LED (4-digit, 7-segment display, and indicating lamps)	
Operation		21 operation keys (protected with polyurethane film)	
External dimensions		150 (5.91) (height) × 60 (2.36) (width) × 14 (0.55) (depth)	
Approximate mass		0.1kg (2.2lbs)	
Max. write operation		100,000 times	

## 26. SELECTION OF PERIPHERAL DEVICE

Voltage	Motor output (kW (HP))	Applicable Inverter Model	Fuse Rating		No-Fuse Breaker (NFB) or GFI Breaker (NV)	Magnetic contactor (MC)			Wire Size (mm <sup>2</sup> )	
			Class	Amp		A	B	C	R. S. T	U. V. W
200 V	0.1(1/8)	FR-A024-0.1K	K5 or H	4	NF30, NV30-5A	S-N11	S-N18	S-N20	2	2
	0.2(1/4)	FR-A024-0.2K	K5 or H	6	NF30, NV30-5A	S-N18	S-N20	S-N20	2	2
	0.4(1/2)	FR-A024-0.4K	K5 or H	12	NF30, NV30-5A	S-N18	S-N21	S-N21	2	2
	0.75(1)	FR-A024-0.75K	K5 or H	20	NF30, NV30-10A	S-N18	S-N21	S-N21	2	2
	1.5(2)	FR-A024-1.5K	K5 or H	35	NF30, NV30-15A	S-N21	S-N25	S-K50	2	2
	2.2(3)	FR-A024-2.2K	K5 or H	45	NF30, NV30-20A	S-N11, S-N12			2	2
400 V	0.4(1/2)	FR-A044-0.4K	K5 or H	7	NF30, NV30-5A	S-N10			2	2
	0.75(1)	FR-A044-0.75K	K5 or H	12	NF30, NV30-5A	S-N10			2	2
	1.5(2)	FR-A044-1.5K	K5 or H	20	NF30, NV30-10A	S-N10			2	2
	2.2(3)	FR-A044-2.2K	K5 or H	25	NF30, NV30-15A	S-N20			2	2
	3.7(5)	FR-A044-3.7K	K5 or H	40	NF30, NV30-20A	S-N20			2	2

- Notes:**
1. Select the model of no-fuse breaker (NFB) meeting the power supply capacity.
  2. The wire size is specified assuming the wiring distance of 20m (65.6 feet).
  3. It is not necessary to use a magnetic contactor at the inverter power supply. However, if one is used, its selection should be made at referring to the diagram below; selection should be made based on the power supply capacity and wiring distance. For FR-A024-0.4K to 1.5K (FR-A044-0.4K to 1.5K), if power factor improving AC reactor FR-BAL is used, S-N10 should be selected.
  4. If wiring distance is longer than 20m (65.6 feet), refer to page 11.

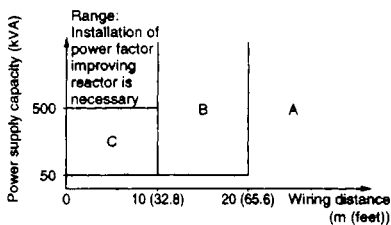

**Note:** The power supply capacity in this diagram is applicable when the specified wire size is used.

## 26. SELECTION OF PERIPHERAL DEVICE

### ● Installation and selection of no-fuse breaker

To protect the wiring in the primary side of the inverter, it is necessary to install a fuse or no-fuse breaker (NFB). The NFB must be selected with regard to the power factor at the power supply side of inverter (will vary according to power supply voltage, output frequency, and load). For selection, refer to the table above. Especially, when a NFB of electromagnetic type is used, the operating characteristics vary due to high harmonic currents. This means that the NFB which is one rank above the proper size must be selected.

### ● Power factor improving AC reactor

If the inverter is connected directly to a large capacity power transformer (capacity: 500kVA or larger, wiring distance: 10m (32.83 feet) or smaller), or a phase advancer capacitor is used, an excessive peak current may flow through the power supply input circuit to damage the converter. In this situation, it may be necessary to install a power factor improving AC reactor like the FR-BAL (option).

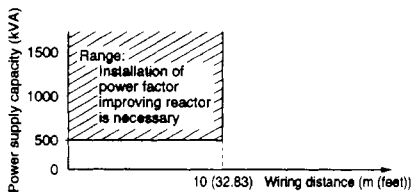
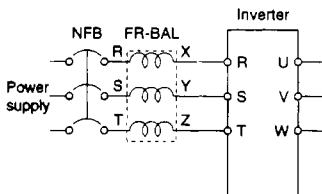

- Notes:**
1. Input power factor is improved to approx. 90%.
  2. Select the power factor improving AC reactor to meet the motor capacity. Even if the inverter capacity is large than the motor capacity, selection must be made on the basis of motor capacity.
  3. For the motor smaller than 0.4kW (1/2 HP), select the reactor for 0.4kW (1/2 HP) motor. In this case, power factor will be a little lower than 90%.

## 26. SELECTION OF PERIPHERAL DEVICE

### ● Selecting the Rated Sensitivity Current for the Earth Leakage Circuit Breaker

When using the earth leakage circuit breaker with the inverter circuit, select its rated sensitivity current as follows:

- News Super NV series (Type SF, CF)  
Rated sensitivity current:  $I_{\Delta n} \geq 10 \times (I_{g1} + I_{g2} + I_{gm})$
- Conventional NV series (Type CA, CS, SS)  
Rated sensitivity current:  $I_{\Delta n} \geq 10 \times \{(I_{g1} + I_{gn} + 3 \times (I_{g2} + I_{gm}))\}$

$I_{g1}, I_{g2}$  : leakage currents of cable path during commercial power supply operation

$I_{gn}^*$  : leakage current of noise filter on inverter input side

$I_{gm}$  : leakage current of motor during commercial power supply operation

<Example>

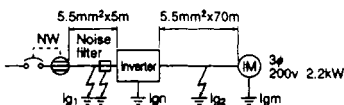

- \* For the leakage current value of the noise filter installed on the inverter input side, contact the corresponding filter manufacturer. (For Mitsubishi's dedicated filters, refer to page 136, 137.)

### Selection Example

(for the diagram shown on the left) (mA)

	New Super NV	Conventional NV
Leakage current $I_{g1}$	$33 \times \frac{5m}{1000m} = 0.17$	
Leakage current $I_{gn}$	0 (Without noise filter)	
Leakage current $I_{g2}$	$33 \times \frac{70m}{1000m} = 2.31$	
Motor leakage current $I_{gm}$	0.18	
Total leakage current	2.66	7.64
Rated sensitivity current ( $\geq I_g \times 10$ )	30	100

**Note:** 1. The NV should be installed to the primary (power supply) side of the inverter.

2. In the Y connection neutral point grounded system, the sensitivity current is purified against ground fault in the inverter secondary side. Hence, the protective ground resistance of the load equipment should be  $10\Omega$  or less.

- Leakage Current Example of Cable Path during Commercial Power Supply Operation When the CV Cable is Routed in Metal Conduit (200V 60Hz)

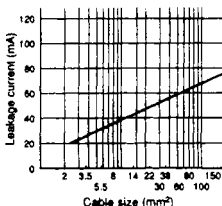

- Leakage Current Example of 3-Phase induction Motor during Commercial Power Supply Operation (200V 60Hz)

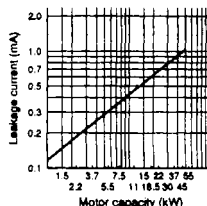

## 27. OPTION

### ■ List of Options

Name		Model	Application, specifications		Applicable inverter
Remote installation	Parameter unit (English)	FR-PU03E	Digital data setting and monitoring equipment		Special for FR-A024/A044 series
	Parameter copy unit (English)	FR-ARW03E	For collective writing of the set values; with verify function		
	Digital operation panel	FR-DU01	Operation panel		
	Analog operation panel	FR-AU03	Operation panel with frequency meter, frequency setter and start switch (for inverter installation)		
	Computer communication unit	FR-CU03	RS-485 interface for computer link (computer communication)		
	Accessory cover	-	Cover to be fitted on the inverter when a parameter unit is removed.		
	Computer communication unit	FR-CU01	RS-485 interface for computer link (computer communication)		Common to all models
	Parameter unit connection cable	FR-CBL-□□	For connecting the parameter unit or parameter copy unit to the inverter Straight type and L-pattern type		
	Brake resistor	MRS, MYS	For improving the regenerative performance (permissible duty ratio: 3%)		Depending on capacity
	Brake resistor for high-frequency operation	FR-ABR-(H)□□*	For improving the regenerative performance (permissible duty ratio: 10%)		
	BU brake unit	BU-(H)□□*	For remarkable improvement of the regenerative braking performance		
	Discharge resistor	GZG, GRGZ	Discharge resistor for BU brake unit		
	Brake unit	FR-BU-(H)□□*	For remarkable improvement of the regenerative braking performance		
	AC reactor for improving power factor	FR-BAL-(H)□□*	For improving power supply power factor (power factor: approx. 90%)	Connect on input side	
	Noise filter (in compliance to VDE standard)	-	Noise filter in compliance with VDE standard (VDE871 Class A interference voltage)		Common to all models
	Radio noise filter	FR-BIF-(H)□□*	For reducing radio noise	Connect on input side	
Line noise filter	FR-BSF01	For reducing line noise	Connect on input or output side.		
EMC Directive compliance noise filter	SF□□*	Noise filter in compliance with EMC Directive (N50081-2)			
High power factor converter	FR-HC 7.5K FR-HC-H 7.5K	For high harmonic suppression			

\*: Type for 400VAC class has H.

# 27. OPTION

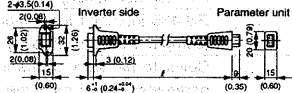
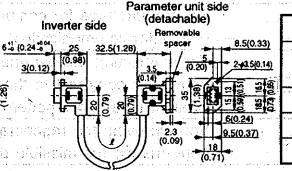
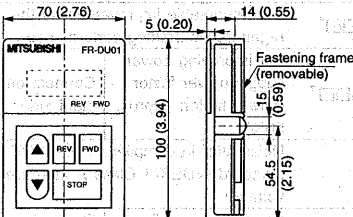
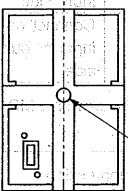
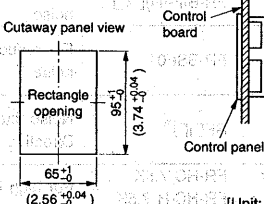
Name (Model)	Specifications and Construction														
Parameter copy unit FR-ARW03 (Japanese) FR-ARW03E (English)	<ul style="list-style-type: none"> <li>This unit reads the parameters set for a specific application collectively and writes (copies) them to other inverters.</li> <li>Ten keys are available.</li> <li>External dimensions are the same as those of a parameter unit.</li> <li>The unit may also be used as a parameter unit.</li> </ul>														
Accessory cover	<ul style="list-style-type: none"> <li>The cover to be fitted on the inverter when a parameter unit is removed.</li> <li>Installation and removal is possible in a one-touch operation.</li> <li>For the model not equipped with a parameter unit, the accessory cover is standard.</li> </ul> 														
Parameter unit connection cable FR-CBL- <input type="text"/>	<ul style="list-style-type: none"> <li>Straight type <span style="float: right;">[Unit: mm (inches)]</span></li> </ul>  <ul style="list-style-type: none"> <li>L type</li> </ul>  <table border="1" data-bbox="668 542 984 706"> <thead> <tr> <th colspan="2">Model</th> <th rowspan="2">Length <math>l</math> m (inches)</th> </tr> <tr> <th>Straight type</th> <th>L-type</th> </tr> </thead> <tbody> <tr> <td>FR-CBL01</td> <td>FR-CBL-L1</td> <td>1 (39.37)</td> </tr> <tr> <td>FR-CBL03</td> <td>FR-CBL-L3</td> <td>3 (118.11)</td> </tr> <tr> <td>FR-CBL05</td> <td>FR-CBL-L5</td> <td>5 (196.85)</td> </tr> </tbody> </table> <p>With the L-pattern type cable, the connector may be affixed to the parameter with screws as with the connector on the inverter side.</p>	Model		Length $l$ m (inches)	Straight type	L-type	FR-CBL01	FR-CBL-L1	1 (39.37)	FR-CBL03	FR-CBL-L3	3 (118.11)	FR-CBL05	FR-CBL-L5	5 (196.85)
Model		Length $l$ m (inches)													
Straight type	L-type														
FR-CBL01	FR-CBL-L1	1 (39.37)													
FR-CBL03	FR-CBL-L3	3 (118.11)													
FR-CBL05	FR-CBL-L5	5 (196.85)													
Digital operation panel (on enclosure) FR-DU01	<p><b>Notes:</b> 1. This remote operator panel cannot be mounted on the inverter. Connect this operator panel using the parameter unit connection cable.</p> <div style="display: flex; justify-content: space-between;"> <div style="width: 45%;">  <p><b>Rear view</b></p>  </div> <div style="width: 45%;"> <p>2. Installation</p> <ul style="list-style-type: none"> <li>Cut the rectangle opening in the enclosure.</li> <li>Mount the operation panel from the front and mount the fixing frame from the rear of the panel and fix them in place with the clamp screw.</li> <li>Plate thickness: 0.6 (0.02 inches) to 3.2mm (0.13 inches)</li> </ul> <p>3. The operation panel cannot read and write the parameters.</p>  <p style="text-align: right;">[Unit: mm (inches)]</p> </div> </div>														



# 27. OPTION

OPTION 27

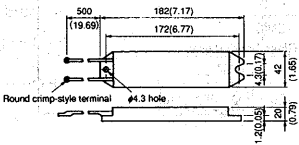
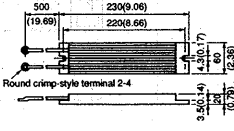
Name	Specifications and Construction				
	<div style="border: 1px solid black; padding: 5px; width: fit-content; margin-bottom: 10px;">MRS-type</div> 	<div style="border: 1px solid black; padding: 5px; width: fit-content; margin-bottom: 10px;">MRS-type</div> 			
Brake resistor MRS MYS	[Unit: mm (inches)]				
200V series (230V)	MRS-type	MRS120W200	200Ω	15	0.4K (1/2HP)
		MRS120W100	100Ω	30	0.75K (1HP)
		MRS120W60	60Ω	55	1.5K (2HP)
		MRS120W40	40Ω	80	2.2K (3HP) 3.7K (5HP)
	MYS-type	MYS220W50*	6%	50Ω/2	2 × 80
*2-line parallel configuration					
<b>Notes</b>					
1. During installation be careful of heat as the brake resistor temperature can rise above 200°C (392 °F) depending on the frequency of operation.					

# 27. OPTION

Name		Specifications and Construction										
Brake resistor for high-frequency operation FR-ABR- <input type="checkbox"/>												
		Unit: mm (inches)										
Brake resistor name	Permissible brake use ratio	External dimensions						Resistance (Ω)	Approx. weight kg (lbs)	Permissible power (W)		
		A	B	C	D	E	F					
200V class (230V)	FR-ABR-0.4K	10%	140 (5.51)	125 (4.92)	100 (3.94)	40 (1.57)	20 (0.79)	2.5 (0.98)	200	0.2 (0.44)	80	
	FR-ABR-0.75K	10%	215 (8.46)	200 (7.87)	175 (6.89)	40 (1.57)	20 (0.79)	2.5 (0.98)	100	0.4 (0.88)	150	
	FR-ABR-2.2K	10%	240 (9.45)	225 (8.86)	200 (7.87)	50 (1.97)	25 (0.98)	2.5 (0.98)	60	0.5 (1.10)	250	
	FR-ABR-3.7K	10%	215 (8.46)	200 (7.87)	175 (6.89)	60 (2.36)	30 (1.18)	2.5 (0.98)	40	0.8 (1.76)	300	
	FR-ABR-5.5K	10%	335 (13.19)	320 (12.60)	295 (11.61)	60 (2.36)	30 (1.18)	2.5 (0.98)	25	1.3 (2.87)	500	
400V class (460V)	FR-ABR-H0.4K	10%	115 (4.53)	100 (3.94)	75 (2.95)	40 (1.57)	20 (0.79)	2.5 (0.98)	1200	0.2 (0.44)	60	
	FR-ABR-H0.75K	10%	140 (5.51)	125 (4.92)	100 (3.94)	40 (1.57)	20 (0.79)	2.5 (0.98)	700	0.2 (0.44)	60	
	FR-ABR-H1.5K	10%	215 (8.46)	200 (7.87)	175 (6.89)	40 (1.57)	20 (0.79)	2.5 (0.98)	350	0.4 (0.88)	150	
	FR-ABR-H2.2K	10%	240 (9.45)	225 (8.86)	200 (7.87)	50 (1.97)	25 (0.98)	2.5 (0.98)	250	0.5 (1.10)	250	
	FR-ABR-H3.7K	10%	215 (8.46)	200 (7.87)	175 (6.89)	60 (2.36)	30 (1.18)	2.5 (0.98)	150	0.8 (1.76)	300	
	FR-ABR-H5.5K	10%	335 (13.19)	320 (12.60)	295 (11.61)	60 (2.36)	30 (1.18)	2.5 (0.98)	110	1.3 (2.87)	500	

\*Common to 1.5K and 2.2K

Notes 1: Duty cycle of the regenerative brake must be lower than the duty cycle given in the table.

2: Depending on operation frequency, brake resistor temperature may exceed 300°C (572 °F).  
Take care when mounting the external brake resistor, surface temperature may cause burns. Lack see (note 2 below) or proper air circulation may cause resistor failure.

## 27. OPTION

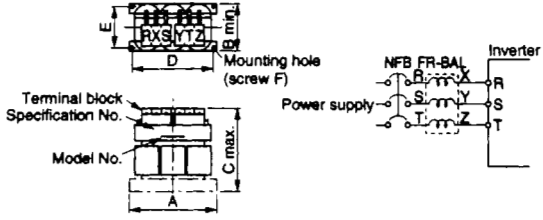
Name	Specifications and Construction																																																																																																																	
AC reactor for improving power factor FR-BAL- <input type="text"/>	 <p style="text-align: right;">Unit: mm (inches)</p>																																																																																																																	
	<table border="1"> <thead> <tr> <th rowspan="2">Capacity</th> <th colspan="6">FR-BAL (200V/230V)</th> <th rowspan="2">Estimated weight (kg/lbs)</th> <th colspan="6">FR-BAL-H (400V/480V)</th> <th rowspan="2">Estimated weight (kg/lbs)</th> </tr> <tr> <th>A</th> <th>B</th> <th>C</th> <th>D</th> <th>E</th> <th>F</th> <th>A</th> <th>B</th> <th>C</th> <th>D</th> <th>E</th> <th>F</th> </tr> </thead> <tbody> <tr> <td>0.4kW</td> <td>135 (5.31)</td> <td>64 (2.52)</td> <td>120 (4.72)</td> <td>120 (1.72)</td> <td>45 (1.77)</td> <td>M4</td> <td>2 (4.4)</td> <td>125 (4.92)</td> <td>64 (2.52)</td> <td>120 (4.72)</td> <td>120 (4.72)</td> <td>45 (1.77)</td> <td>M4</td> <td>2.1 (4.62)</td> </tr> <tr> <td>0.75kW</td> <td>135 (5.31)</td> <td>74 (2.91)</td> <td>120 (4.72)</td> <td>120 (4.72)</td> <td>57 (2.24)</td> <td>M4</td> <td>3 (6.6)</td> <td>150 (5.91)</td> <td>76 (2.99)</td> <td>145 (5.71)</td> <td>145 (5.71)</td> <td>55 (2.17)</td> <td>M4</td> <td>3.7 (8.16)</td> </tr> <tr> <td>1.5kW</td> <td>160 (6.30)</td> <td>76 (2.99)</td> <td>145 (5.71)</td> <td>145 (5.71)</td> <td>55 (2.17)</td> <td>M4</td> <td>4 (8.8)</td> <td>150 (5.91)</td> <td>92 (3.62)</td> <td>145 (5.71)</td> <td>145 (5.71)</td> <td>70 (2.76)</td> <td>M4</td> <td>5.3 (11.68)</td> </tr> <tr> <td>2.2kW</td> <td>160 (6.30)</td> <td>96 (3.78)</td> <td>145 (5.71)</td> <td>145 (5.71)</td> <td>75 (2.95)</td> <td>M4</td> <td>6 (13.2)</td> <td>150 (5.91)</td> <td>96 (3.78)</td> <td>145 (5.71)</td> <td>145 (5.71)</td> <td>75 (2.95)</td> <td>M4</td> <td>5.9 (13.01)</td> </tr> <tr> <td>3.7kW</td> <td>220 (8.66)</td> <td>95 (3.74)</td> <td>200 (7.87)</td> <td>200 (7.87)</td> <td>70 (2.76)</td> <td>M5</td> <td>8.5 (18.7)</td> <td>220 (8.66)</td> <td>95 (3.74)</td> <td>195 (7.68)</td> <td>200 (7.87)</td> <td>70 (2.76)</td> <td>M5</td> <td>8.5 (18.74)</td> </tr> </tbody> </table>												Capacity	FR-BAL (200V/230V)						Estimated weight (kg/lbs)	FR-BAL-H (400V/480V)						Estimated weight (kg/lbs)	A	B	C	D	E	F	A	B	C	D	E	F	0.4kW	135 (5.31)	64 (2.52)	120 (4.72)	120 (1.72)	45 (1.77)	M4	2 (4.4)	125 (4.92)	64 (2.52)	120 (4.72)	120 (4.72)	45 (1.77)	M4	2.1 (4.62)	0.75kW	135 (5.31)	74 (2.91)	120 (4.72)	120 (4.72)	57 (2.24)	M4	3 (6.6)	150 (5.91)	76 (2.99)	145 (5.71)	145 (5.71)	55 (2.17)	M4	3.7 (8.16)	1.5kW	160 (6.30)	76 (2.99)	145 (5.71)	145 (5.71)	55 (2.17)	M4	4 (8.8)	150 (5.91)	92 (3.62)	145 (5.71)	145 (5.71)	70 (2.76)	M4	5.3 (11.68)	2.2kW	160 (6.30)	96 (3.78)	145 (5.71)	145 (5.71)	75 (2.95)	M4	6 (13.2)	150 (5.91)	96 (3.78)	145 (5.71)	145 (5.71)	75 (2.95)	M4	5.9 (13.01)	3.7kW	220 (8.66)	95 (3.74)	200 (7.87)	200 (7.87)	70 (2.76)	M5	8.5 (18.7)	220 (8.66)	95 (3.74)	195 (7.68)	200 (7.87)	70 (2.76)	M5	8.5 (18.74)
	Capacity	FR-BAL (200V/230V)						Estimated weight (kg/lbs)	FR-BAL-H (400V/480V)						Estimated weight (kg/lbs)																																																																																																			
A		B	C	D	E	F	A		B	C	D	E	F																																																																																																					
0.4kW	135 (5.31)	64 (2.52)	120 (4.72)	120 (1.72)	45 (1.77)	M4	2 (4.4)	125 (4.92)	64 (2.52)	120 (4.72)	120 (4.72)	45 (1.77)	M4	2.1 (4.62)																																																																																																				
0.75kW	135 (5.31)	74 (2.91)	120 (4.72)	120 (4.72)	57 (2.24)	M4	3 (6.6)	150 (5.91)	76 (2.99)	145 (5.71)	145 (5.71)	55 (2.17)	M4	3.7 (8.16)																																																																																																				
1.5kW	160 (6.30)	76 (2.99)	145 (5.71)	145 (5.71)	55 (2.17)	M4	4 (8.8)	150 (5.91)	92 (3.62)	145 (5.71)	145 (5.71)	70 (2.76)	M4	5.3 (11.68)																																																																																																				
2.2kW	160 (6.30)	96 (3.78)	145 (5.71)	145 (5.71)	75 (2.95)	M4	6 (13.2)	150 (5.91)	96 (3.78)	145 (5.71)	145 (5.71)	75 (2.95)	M4	5.9 (13.01)																																																																																																				
3.7kW	220 (8.66)	95 (3.74)	200 (7.87)	200 (7.87)	70 (2.76)	M5	8.5 (18.7)	220 (8.66)	95 (3.74)	195 (7.68)	200 (7.87)	70 (2.76)	M5	8.5 (18.74)																																																																																																				
<p><b>Notes:</b></p> <ol style="list-style-type: none"> <li>Input harmonic power factor is improved to approx. 90%.</li> <li>Select the power factor improving AC reactor meeting the motor capacity. (Even if the inverter capacity is larger than the motor capacity, selection must be made on the basis of motor capacity.)</li> <li>For the motor smaller than 0.4kW (1/2 HP), select the reactor for 0.4kW motor. In this case, power factor is a little lower than 90%.</li> </ol>																																																																																																																		

## 27. OPTION

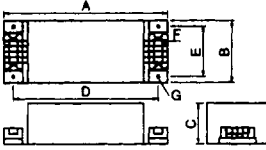
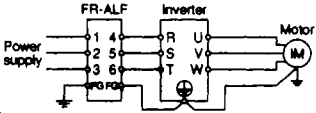
Name	Specifications and construction																																																				
Noise filter (in compliance to VDE standard) FR-ALF- <input type="checkbox"/>	<div style="display: flex; justify-content: space-around; align-items: center;">   </div> <p data-bbox="625 429 951 476">If grounding is made in different manner from the illustration above, noise reduction effect may be lowered.</p> <p data-bbox="832 539 992 561" style="text-align: right;">Unit: mm (inches)</p>																																																				
	<table border="1" style="width: 100%; border-collapse: collapse; text-align: center;"> <thead> <tr> <th>Filter</th> <th>Applicable Inverter</th> <th>A</th> <th>B</th> <th>C</th> <th>D</th> <th>E</th> <th>F</th> <th>G</th> <th>Mass (kg)</th> <th>Leak Current (mA)</th> </tr> </thead> <tbody> <tr> <td>FR-ALF-0.75K</td> <td>FR-A024-0.4K/0.75K</td> <td>340</td> <td>120</td> <td>80</td> <td>295</td> <td>100</td> <td rowspan="3">M4</td> <td rowspan="2">φ 4.5</td> <td rowspan="2">4 (8.8)</td> <td rowspan="3">1</td> </tr> <tr> <td>FR-ALF-2.2K</td> <td>FR-A024-1.5K/2.2K</td> <td>(13.26)</td> <td>(4.68)</td> <td>(3.12)</td> <td>(11.50)</td> <td>(3.9)</td> </tr> <tr> <td>FR-ALF-3.7K</td> <td>FR-A024-3.7K</td> <td>390</td> <td>150</td> <td>100</td> <td>345</td> <td>120</td> <td>φ 5.5</td> <td>7 (15.4)</td> </tr> <tr> <td>FR-ALF-H0.75K</td> <td>FR-A044-0.4K/0.75K</td> <td rowspan="3">390</td> <td rowspan="3">150</td> <td rowspan="3">100</td> <td rowspan="3">345</td> <td rowspan="3">120</td> <td rowspan="3">M4</td> <td rowspan="3">φ 5.5</td> <td rowspan="3">6 (13.2)</td> <td rowspan="3">3.5</td> </tr> <tr> <td>FR-ALF-H2.2K</td> <td>FR-A044-1.5K/2.2K</td> </tr> <tr> <td>FR-ALF-H3.7K</td> <td>FR-A044-3.7K</td> </tr> </tbody> </table>	Filter	Applicable Inverter	A	B	C	D	E	F	G	Mass (kg)	Leak Current (mA)	FR-ALF-0.75K	FR-A024-0.4K/0.75K	340	120	80	295	100	M4	φ 4.5	4 (8.8)	1	FR-ALF-2.2K	FR-A024-1.5K/2.2K	(13.26)	(4.68)	(3.12)	(11.50)	(3.9)	FR-ALF-3.7K	FR-A024-3.7K	390	150	100	345	120	φ 5.5	7 (15.4)	FR-ALF-H0.75K	FR-A044-0.4K/0.75K	390	150	100	345	120	M4	φ 5.5	6 (13.2)	3.5	FR-ALF-H2.2K	FR-A044-1.5K/2.2K	FR-ALF-H3.7K
Filter	Applicable Inverter	A	B	C	D	E	F	G	Mass (kg)	Leak Current (mA)																																											
FR-ALF-0.75K	FR-A024-0.4K/0.75K	340	120	80	295	100	M4	φ 4.5	4 (8.8)	1																																											
FR-ALF-2.2K	FR-A024-1.5K/2.2K	(13.26)	(4.68)	(3.12)	(11.50)	(3.9)																																															
FR-ALF-3.7K	FR-A024-3.7K	390	150	100	345	120		φ 5.5	7 (15.4)																																												
FR-ALF-H0.75K	FR-A044-0.4K/0.75K	390	150	100	345	120	M4	φ 5.5	6 (13.2)	3.5																																											
FR-ALF-H2.2K	FR-A044-1.5K/2.2K																																																				
FR-ALF-H3.7K	FR-A044-3.7K																																																				

## 27. OPTION

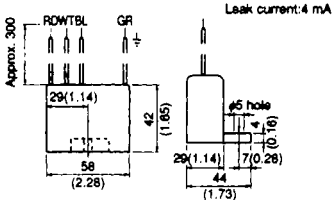
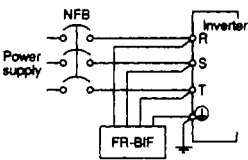
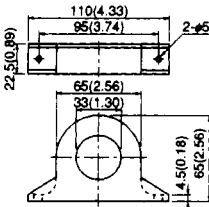
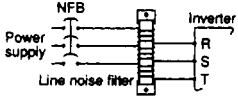
Name	Specifications and Construction	
<p>Radio noise filter FR-BIF(-H)</p>	<p>[Unit: mm (inches)]</p>  <p>Leak current: 4 mA</p>	 <p>Notes 1: The radio noise filter cannot be connected to the output side of the inverter. 2: The connection wire must be as short as possible; connect to the terminal block of the inverter.</p>
<p>Line noise filter FR-BSF01</p>	<p>[Unit: mm (inches)]</p> 	 <p>Notes 1: Wind the wire more than 3 turns (4T) in the same direction for each phase. Larger number of turns provides better filtering effect. 2: The filter can be used at the output side in the same manner as at the input side. At the output side, however, the wire should be wound less than 3 turns (4T).</p>

## 27. OPTION

FR-CU01

Name (Model)	Specifications and Construction
Computer communication unit FR-CU01	<ul style="list-style-type: none"> <li>• Connect with the parameter unit connection cable.</li> <li>• The inverter operation, monitor and parameter settings are possible from an FA controller, etc., by using the RS-485 interface.</li> <li>• No. of connected multi-drop link units: 31 units</li> <li>• Transmission rate: 1200 baud</li> </ul> <p style="text-align: right;">[Unit: mm (inches)]</p> <p>The drawing shows three views of the FR-CU01 unit:</p> <ul style="list-style-type: none"> <li><b>Front View:</b> A rectangular unit with a height of 127(5.00) mm and a width of 70(2.76) mm. It features a top section labeled 'INSTALLATION' and 'POWER FOR ERROR' with terminals 'P' and 'S'. A 'Wiring space' of 42(1.65) x 7(0.28) mm is indicated at the bottom.</li> <li><b>Side View:</b> Shows a depth of 38(1.50) mm and a height of 7(0.28) mm. It includes a 'Max. opening angle of small door' of 70° and a base width of 22(0.87) mm.</li> <li><b>Top View:</b> Shows a total width of 117(4.61) mm and a depth of 50(2.00) mm. It features a '2-φ2.4 hole' for a 'Tapping screw M3 X 6' and a '2-M3 screw' with an 'Effective screw depth 4.5mm(0.18inches)'. A distance of 20(0.79) mm is marked from the center to the hole.</li> </ul>

# 27. OPTION

## CU03

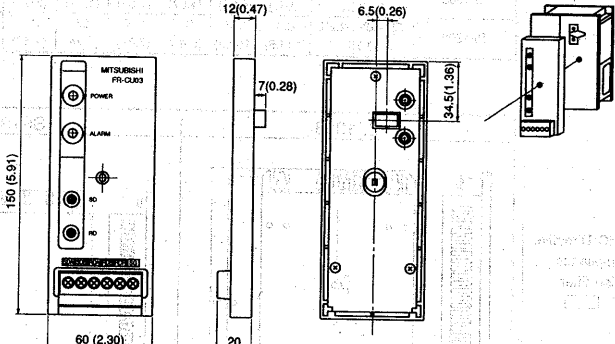
Name (Model)	Specifications and Construction
Compatible Computer Link Option FR-CU03 RS422A/485	<p data-bbox="174 219 526 244">For specification refer to FR-CU03 manual</p> <p data-bbox="709 230 896 259">[Unit: mm (inches)]</p> <p data-bbox="751 296 906 363">Connect to the PU connector on the FR-A024 and use.</p>  <p data-bbox="212 786 543 823">Note : FR-CU03 must not be used with parameter unit connection cable.</p>

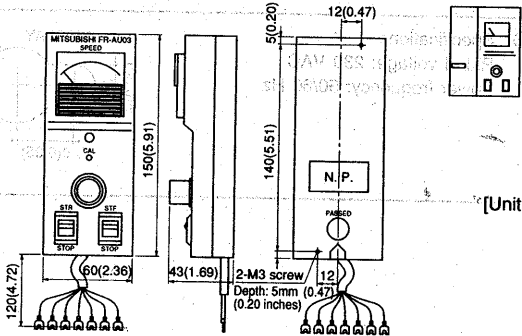
Analog operation panel FR-AU03	<p data-bbox="725 882 896 927">Install onto the FR-A024 and use.</p> <p data-bbox="725 1164 906 1194">[Unit: mm (inches)]</p> 
---	--

## 27. OPTION

Name (Model)	Specifications and Construction																																												
EMC Directive compliance noise filter SF <input type="checkbox"/>	[Noise filter for 3-phase 200 V class FR-A024]																																												
	①. Noise filter type and outline dimension drawing																																												
	<table border="1"> <thead> <tr> <th rowspan="2">Filter type</th> <th rowspan="2">Applicable inverter type</th> <th colspan="5">Outline dimensions(mm (Inches))</th> <th rowspan="2">Weight [kg (lbs)]</th> <th rowspan="2">Loss [W]</th> <th rowspan="2">Leakage current (mA)</th> </tr> <tr> <th>E</th> <th>D</th> <th>A</th> <th>B</th> <th>C</th> </tr> </thead> <tbody> <tr> <td>SF1308</td> <td>FR-A024-0.1K to 1.5K</td> <td>244 (9.61)</td> <td>234 (9.21)</td> <td>104 (4.07)</td> <td>140 (5.51)</td> <td>45 (1.77)</td> <td>1.2 (2.65)</td> <td>5.6</td> <td>22</td> </tr> <tr> <td>SF1309</td> <td>FR-A024-2.2K /3.7K</td> <td>281 (11.06)</td> <td>268 (10.55)</td> <td>164 (6.46)</td> <td>200 (7.89)</td> <td>57 (2.24)</td> <td>2.1 (4.63)</td> <td>15</td> <td>15</td> </tr> </tbody> </table>	Filter type	Applicable inverter type	Outline dimensions(mm (Inches))					Weight [kg (lbs)]	Loss [W]	Leakage current (mA)	E	D	A	B	C	SF1308	FR-A024-0.1K to 1.5K	244 (9.61)	234 (9.21)	104 (4.07)	140 (5.51)	45 (1.77)	1.2 (2.65)	5.6	22	SF1309	FR-A024-2.2K /3.7K	281 (11.06)	268 (10.55)	164 (6.46)	200 (7.89)	57 (2.24)	2.1 (4.63)	15	15									
Filter type	Applicable inverter type			Outline dimensions(mm (Inches))								Weight [kg (lbs)]	Loss [W]	Leakage current (mA)																															
		E	D	A	B	C																																							
SF1308	FR-A024-0.1K to 1.5K	244 (9.61)	234 (9.21)	104 (4.07)	140 (5.51)	45 (1.77)	1.2 (2.65)	5.6	22																																				
SF1309	FR-A024-2.2K /3.7K	281 (11.06)	268 (10.55)	164 (6.46)	200 (7.89)	57 (2.24)	2.1 (4.63)	15	15																																				
SF1308					SF1309																																								
②. Specifications Rated voltage: 230 VAC Power frequency: 50/60 Hz																																													



## 27. OPTION

Name (Model)	Specifications and Construction						
[Noise filter for 3-phase 400 V class FR-A044]							
①. Noise filter type and outline dimension drawing							
Filter type	Applicable inverter type	Outline dimensions [mm (Inches)]			Weight [kg (lbs)]	Loss [W (HP)]	Leakage current (mA)
		A	B	C			
SF1172A	FR-A044-0.4K /0.75K	104 (4.09)	140 (5.51)	38 (1.50)	0.9 (1.98)	5.1	28
SF1173A	FR-A044-1.5K to 3.7K	164 (6.46)	200 (7.89)	46 (1.81)	1.6 (3.53)	9.7	57
EMC Directive compliance noise filter							
	<p>[Unit: mm (inches)]</p> <p>KEYWAY</p> <p>Rotate 90° to the right</p>						
<p>②. Specifications</p> <p>Rated voltage: 460 VAC</p> <p>Power frequency: 50/60 Hz</p>							

## 27. OPTION

### (2) High power factor converter (FR-HC)

- The input power factor can be improved to approx. 1 (when load rate is 100%), so the wire facility capacity can be reduced to approx. 2/3.
- The power regeneration function is mounted as a standard, so a large control capacity can be achieved. (100% continuous regeneration is possible.)
- Multiple inverters can be connected to one high power factor converter.
- The high power factor converter unit and standard accessory standalone box, reactor 1 and reactor 2 are used in combination.

### ■ Specifications

Type FR-HC- <input type="checkbox"/>		200V	400V
		7.5K	H7.5K
Applicable inverter capacity (Note 1)		3.7 kW or less	3.7 kW or less
Rated input voltage/frequency		3-phase 200V to 220V 50Hz 200V to 230V 60Hz	3-phase 380V to 460V 50/60Hz
Rated input current (A)		33	17
Rated output voltage (V)		293V to 335V DC	558V to 670V DC
Approximate weight	Unit (kg (lbs))	8 (17.64)	9 (19.84)
	Accessories (reactor 1, 2, exterior box) total (kg (lbs))	20.3 (44.75)	22.7 (50.04)

(Note 1) The applicable inverter for the high power factor converter is the applicable capacity of the total capacity.

(Note 2) The 3.7 K must always be connected to one unit. (When not connecting and using the 3.7 K inverter, use as a common converter or regenerative converter is possible, but the power high frequency suppressing effect will drop.)

(Note 3) The output voltage will change according to the input voltage value.

### ■ Outline dimensions

Unit: mm (inches)

Capacity	High power factor converter FR-HC			Reactor 1 FR-HCL01			Reactor 2 FR-HCL02			Exterior box FR-HCB		
	W	H	D	W	H	D	W	H	D	W	H	D
7.5K	220 (8.66)	300 (11.81)	190 (7.48)	160 (6.30)	155 (6.10)	100 (3.94)	240 (9.45)	230 (9.06)	160 (6.30)	190 (7.48)	320 (12.60)	165 (6.50)
H7.5K	220 (8.66)	300 (11.81)	190 (7.48)	160 (6.30)	150 (5.91)	100 (3.94)	240 (9.45)	220 (8.66)	160 (6.30)	190 (7.48)	320 (12.60)	165 (6.50)

High power factor converter

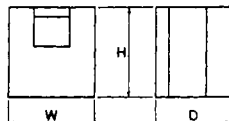

Reactor 1, 2

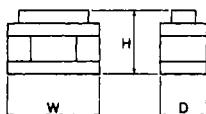

Exterior box

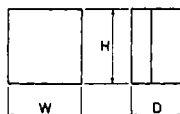

## 27. OPTION

### ■ Basic connection diagram

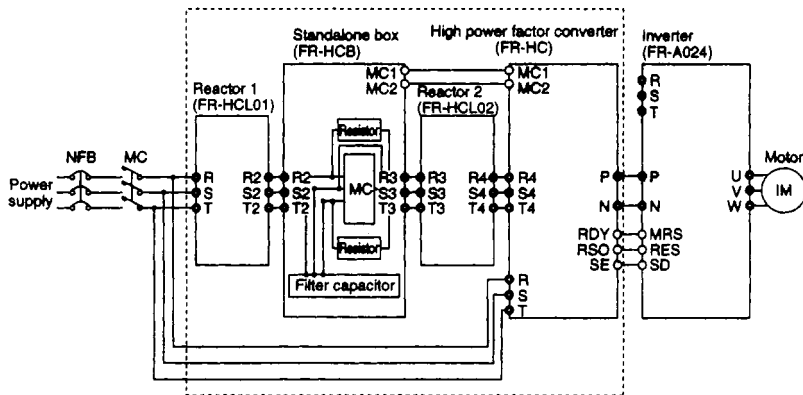

- Note**
1. Always leave the inverter's power supply input terminals R, S and T open. If connected incorrectly, the inverter could be damaged. Note that the inverter could also be damaged if the polarity of the terminals P and N is mistaken.
  2. Match the wire phase and connect the terminals R4, S4, T4 and terminals R, S and T.
  3. Check the connection order of reactor 1 and reactor 2. If the connection is mistaken, the reactor could heat up.
  4. Connect the FR-HC RDY terminal to the terminal set as "6 (MRS)" with Pr. 59 "Input terminal allocation".

## 27. OPTION

### (1) Brake unit

#### ■ BU Brake Unit (BU-(H) )

- The brake unit is an option used for improving the regenerative braking performance.
- It must always be used in combination with a discharge resistor. Select the brake unit meeting the required braking torque.

#### ● Brake unit selection table

Line voltage	Motor (kW) (HP)		0.4 (1/2)	1.5 (2)	2.2 (3)	3.7 (5)
	Braking torque		0.75 (1)			
200V class	50% 30 min.		BU-1500		BU-3700	
	100% 30 min.		BU-1500	BU-3700	BU-7.5K	
400V class	50% 30 min.		BU-H7.5K			
	100% 30 min.		BU-H7.5K			

#### ● Combination between brake unit and discharge

Brake unit	Discharge resistor	Wire to be Used (P, N)
BU-1500	GGZ300W-50Ω	2mm <sup>2</sup>
BU-3700	GRGZ200-10Ω Serial connection (3 pcs.)	2mm <sup>2</sup>
BU-7.5K	GRGZ300-5Ω Serial connection (4 pcs.)	3.5mm <sup>2</sup>
BU-H7.5K	GRGZ200-10Ω Serial connection (6 pcs.)	2mm <sup>2</sup>

## 27. OPTION

### External Dimensions

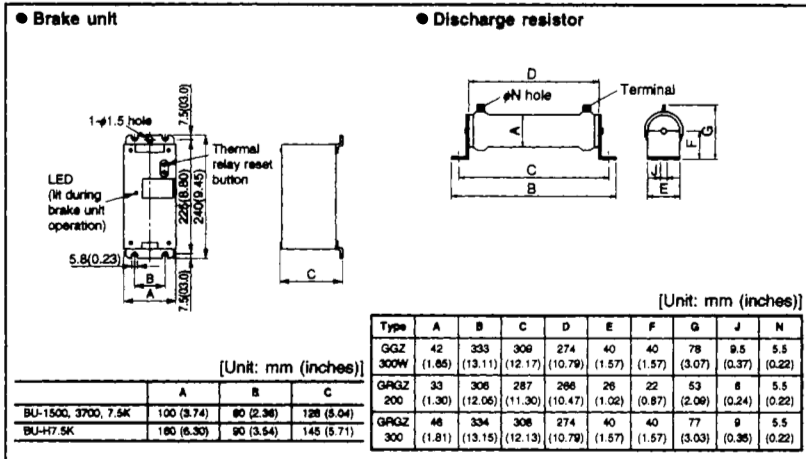

### Wiring Example

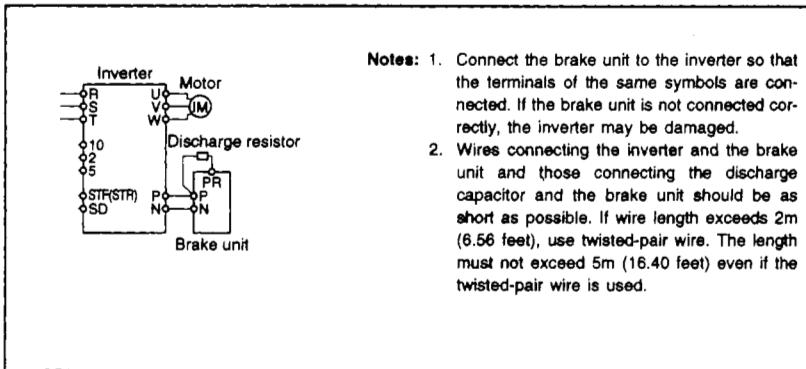

### Cautions on Handling

1. If the brake unit keeps operating beyond its rating, the thermal relay incorporated in the brake unit will trip. If the thermal relay is tripped, reset it and increase the deceleration time of the inverter.
2. The discharge capacitor will be heated to 100°C (212°F). Use high temperature wire and insure that wires are not exposed. Wires may get hot enough to burn the skin.

## 27. OPTION

### ■ Brake Unit (FR-BU)

- The brake unit and resistor are both options used for improving the regenerative braking performance of the inverter. They are always used in a set.
- Select the brake unit and the resistor from the selection table, meeting the required braking torque and deceleration time.
- The brake unit is equipped with the 7-segment LEDs which indicates the duty cycle (%ED) includes and the resistor cooling time alarm code.

### ● Brake unit selection table

Motor capacity	Brake unit	Resistor
0.1K (1/8HP)	FR-BU-15K	GGZ300W-50Ω
0.2K (1/4HP)		GGZ300W-50Ω
0.4K (1/2HP)		GGZ300W-50Ω
0.75K (1HP)		GGZ300W-50Ω
1.5K (2HP)		GRGZ200-10Ω Serial connection (3 pcs.)
2.2K (3HP)		GRGZ300-5Ω Serial connection (4 pcs.)
3.7K (5HP)		GRGZ300-50Ω Serial connection (4 pcs.)
0.4K (1/2HP)	FR-BU-H15K	GGZ300W-200Ω
0.75K (1HP)		GGZ300W-200Ω
1.5K (2HP)		GRGZ300-20Ω Serial connection (4 pcs.)
2.2K (3HP)		GRGZ300-20Ω Serial connection (4 pcs.)
3.7K (5HP)		GRGZ300-20Ω Serial connection (4 pcs.)

### ● Short-time permissible power

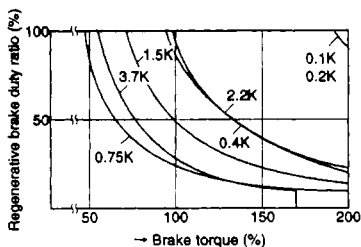

## 27. OPTION

### External Dimensions

#### ● Brake unit

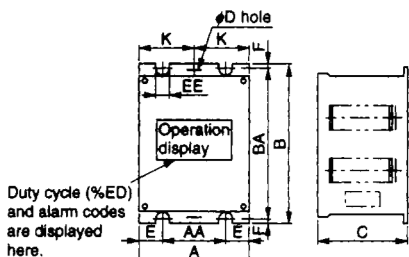

[Unit: mm (inches)]

Brake unit type		A	AA	B	BA	C	D	E	EE	K	F	Mass (kg (lbs))
200V	FR-BU-15K	100 (3.94)	60 (2.36)	240 (9.45)	225 (8.86)	128 (5.04)	6 (0.24)	18.5 (0.73)	6 (0.24)	48.5 (1.91)	7.5 (0.30)	2.4 (5.29)
400V	FR-BU-H15K	160 (6.30)	90 (3.54)	240 (9.45)	225 (8.86)	128 (5.04)	6 (0.24)	33.5 (1.32)	6 (0.24)	78.5 (3.09)	7.5 (0.30)	3.2 (7.05)

#### ● Discharge resistor

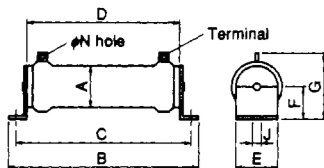

[Unit: mm (inches)]

Type	A	B	C	D	E	F	G	J	N
GGZ300W	42 (1.65)	333 (13.11)	309 (12.17)	274 (10.79)	40 (1.57)	40 (1.57)	78 (3.07)	9.5 (0.37)	5.5 (0.22)
GRGZ200	33 (1.30)	308 (12.05)	287 (11.30)	266 (10.47)	26 (1.02)	22 (0.87)	53 (2.09)	6 (0.24)	5.5 (0.22)
GRGZ300	46 (1.81)	334 (13.15)	308 (12.13)	274 (10.79)	40 (1.57)	40 (1.57)	77 (3.03)	9 (0.35)	5.5 (0.22)

## 27. OPTION

### ■ Wiring Example

**Caution:** Wires connecting the inverter and the brake unit and those connecting the resistor and the brake unit should be as short as possible. If wire length exceeds 5m (16.41 feet), use twisted-pair wire. The length must not exceed 10m (32.82 feet) even if the twisted-pair wire is used. Use the wire of the recommended size or larger.

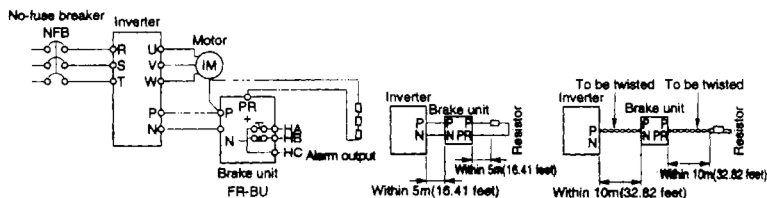

### ■ Selection of Brake Resistor

- Use an external brake resistor to increase the braking torque and permissible duty cycle (%ED). For 0.1K and 0.2K, brake resistor cannot be used.

Voltage	Capacity	Permissible Duty Ratio: 3%ED		Permissible Duty Ratio: 10%ED	
		100% Torque	150% Torque	100% Torque	150% Torque
200 V	0.4K	⇒	MRS 120W200	⇒	FR-ABR-0.4K
	0.75K	⇒	MRS 120W100	⇒	FR-ABR-0.75K
	1.5K	⇒	MRS 120W60	⇒	FR-ABR-2.2K
	2.2K	MRS 120W60	MRS 120W40 *1	FR-ABR-2.2K	FR-ABR-3.7K
	3.7K	MRS 120W40	MYS 220W50 (Parallel connection (2 pcs.))	FR-ABR-3.7K	FR-ABR-5.5K
400 V	0.4K	-	-	FR-ABR-H0.4K	-
	0.75K	-	-	FR-ABR-H0.75K	-
	1.5K	-	-	FR-ABR-H1.5K	-
	2.2K	-	-	FR-ABR-H2.2K	-
	3.7K	-	-	FR-ABR-H3.7K	-

\*1 Permissible Duty Ratio 6% ED



# APPENDICES

## Appendix 1. INSTRUCTIONS FOR COMPLIANCE WITH THE EUROPEAN DIRECTIVES (LVD compliant product has CE marking.)

### 1. EMC DIRECTIVE

(1) Our view of inverters for the EMC Directive

An inverter does not function independently. It is a component designed for installation in a control box and for use with another equipment to control a machine or equipment. Therefore, we do not think that the EMC Directive applies directly to inverters. For this reason, we do not place a CE mark on the inverter. CE mark placed on the inverter shows compliance to the Low Voltage Directive. The European power drive manufacturers' organization (CEMEP) also holds this point of view.

(2) Compliance

We do not think that the inverters themselves are covered directly by the EMC Directive. However, the EMC Directive applies to machines and equipment into which inverters have been incorporated, and these machines and equipment must carry the CE mark. Hence, we have prepared a technical document "EMC Installation Guidelines" (manual number BCN-A21041-202) so that machines and equipment incorporating inverters may conform to the EMC Directive more easily.

(3) Outline of installation method

It is recommended to install an inverter in the following method:

- \* Use the inverter with an European Standard-compliant noise filter.
- \* For wiring between the inverter and motor, use shielded cables or run cables in metal conduit and ground the cables or conduit at the inverter and motor ends. Use the shortest possible cable length.
- \* Install the inverter in an grounded metal enclosure. The enclosure should prevent radiated noise leakage.
- \* Insert a line noise filter and ferrite core into the power and control lines are required.

Full information including the European Standard-compliant noise filter specifications are published in the "EMC Installation Guidelines" (manual number BCN-A21041-202). Please contact your sales representative.

### 2. Low Voltage Directive

(1) Our view of inverters for the Low Voltage Directive

Inverter are covered by the Low Voltage Directive.

(2) Compliance

We declare we meet Low Voltage Directive and place CE marking on the inverter.

The European verification institution has approved that our inverters conform to DIN VDE0160.

(3) Instructions

To conform to DIN VDE0160, the following specifications and instructions listed are different from those of the standard models.

- \* In the 400V class inverters, the rated input voltage range is 3-phase, 380V to 415V, 50/60Hz.
- \* Do not use residual current device as the only protection against indirect contact. Protective earth connection is essential.
- \* Wire the earth terminal independently. (Do not connect two or more cables.)
- \* Only use EN or IEC compliant no-fuse breaker and magnetic contractor.
- \* Use the inverter under condition of Over Voltage Category II and Pollution Degree 2 or better.
  - ① Insert an EN or IEC Standard-compliant isolation transformer or surge suppressor to make the Over Voltage Category II if power supply over voltage category is III or IV.
  - ② Install in a cabinet with IP54 rating or better to have Pollution Degree 2.
- \* For the input and output of the inverter, only use cables of the type and size set forth in EN60204 Appendix C.
- \* The rating of the alarm output relay is 30V DC, 0.3A. There is basic insulation between the alarm output relay and the inverter control circuit.

# APPENDICES

## Appendix 2. INSTRUCTIONS FOR COMPLIANCE WITH THE UL STANDARD (UL listed product has UL marking.)

### 1. UL STANDARD

The UL Standard is the most general standard for motor control equipment in the USA. This standard sets forth the safety of equipment, instruments and materials to protect lives and properties from fire, electric shock and other accidents. Inverters are covered by UL508C (Power Conversion Equipment) as part of power conversion equipment.

### 2. REQUIREMENT OF UL LISTING

In the U.S.A., laws are multiplexed, i.e. there are federal law and state, municipal and other local laws. The Federal Government provides for only the least required legal regulations and the local governments provide for particulars. Therefore we are not compelled by the federal law to be compelled by the federal law to comply with the UL Standard. It should be noted that the laws of several local governments require products to be certified as safe by the UL or other testing institution, and in local governments which do not have legal regulations, the minimum requirement of the federal law that "products should be safe" must be fulfilled.

### 3. INSTRUCTIONS

When using the UL-listed FR-A024, refer to the following:

(1) Installation

The FR-A024 is UL-listed as a product used in an enclosure. Install it in an enclosure.

(2) Wiring of power supply and motor

When wiring the input (R, S, T) and output (U, V, W) terminals of the inverter, refer to the following list and use the UL-listed round crimping terminals. Use a crimping tool recommended your terminal manufacture to crimping terminals.

Applicable Inverter Model	Screw Size	Tightening Torque kgf · cm	Crimping Terminals		Wires (Note)			
					mm <sup>2</sup>		AWG	
			R, S, T	U, V, W	R, S, T	U, V, W	R, S, T	U, V, W
FR-A024-0.1K-UL	M 3.5	12	2-3.5	2-3.5	2	2	14	14
FR-A024-0.2K-UL	M 3.5	12	2-3.5	2-3.5	2	2	14	14
FR-A024-0.4K-UL	M 3.5	12	2-3.5	2-3.5	2	2	14	14
FR-A024-0.75K-UL	M 3.5	12	2-3.5	2-3.5	2	2	14	14
FR-A024-1.5K-UL	M 3.5	12	2-3.5	2-3.5	2	2	14	14
FR-A024-2.2K-UL	M 4	15	2-4	2-4	2	2	14	14
FR-A024-3.7K-UL	M 4	15	5.5-4	5.5-4	3.5	3.5	12	12
FR-A044-0.4K-UL	M 3.5	12	2-3.5	2-3.5	2	2	14	14
FR-A044-0.75K-UL	M 3.5	12	2-3.5	2-3.5	2	2	14	14
FR-A044-1.5K-UL	M 3.5	12	2-3.5	2-3.5	2	2	14	14
FR-A044-2.2K-UL	M 4	15	2-4	2-4	2	2	14	14
FR-A044-3.7K-UL	M 4	15	2-4	2-4	2	2	14	14

Note: Use 75°C copper wires.

(3) Short circuit ratings

The drive is suitable for use on a Circuit Capable of delivering not more than \_\_\_ RMS Symmetrical Amperes, 500 volts Maximum.

Inverter Capacity	*
0.75kW or less	1,000
1.5kW to 3.7kW	5,000

# APPENDICES

---

## Appendix 3. WARRANTY

### **"WARRANTY"**

#### **1. Exceptions to the warranty, such as opportunity losses**

We do not warrant to reimburse you or your customers for opportunity losses, damage to produce other than ours, or any other businesses which result from a failure of our product, whether such failure has occurred within the free warranty period or not.

#### **2. Repair after production stop**

If we stop producing any of our models (products), we will repair such model within seven years after the month of the year when its production is stopped.

#### **3. Delivery condition**

It is understood that a standard product which does not include setting and/or adjustment in applications is delivered when it arrives on your premises, and we are not obliged to adjust or test run such product on the spot.

### **⚠ Application of this product**

- This product is not designed or manufactured for use with any equipment or system which will be operated under conditions hazardous to life.
- If you are planning to use this product in any specific application such as passenger mobile, medical, aerospace, atomic, power or submarine junction equipment or system, please refer to our business department.
- This product is manufactured under rigorous quality control. However, safety devices should be installed if this product is applied to any facility that may result in a serious accident or loss due to a failure of this product.
- This product should only be used with a load of three-phase induction motor.

# MEMO

## Revisions

- The manual number is given on the bottom left of the back cover.

Print data	*Manual number	Revision
Jul., 1994	IB (NA) 66522-A	First edition
Sep., 1995	IB (NA) 66522-B	Revisions due to changes in specifications
Jan., 1997	IB (NA) 66522-C	<b>Additions</b> <ul style="list-style-type: none"><li>•Wiring procedures (Page 17)</li><li>•Power harmonic guidelines (Japan) (Page 114)</li><li>•Selecting the Rated Sensitivity Current for the Earth Leakage Circuit Breaker (Page 130)</li><li>•EMC Directive-compliant noise filter (Page 140, 141)</li><li>•High power factor converter (Page 142, 143)</li><li>•Instructions for compliance with the European Directives</li><li>•Instructions for compliance with the UL Standard</li><li>•WARRANTY</li></ul>



# MITSUBISHI ELECTRIC CORPORATION

HEAD OFFICE: MITSUBISHI DENKI BLDG. MARUNOUCHI TOKYO 100

TYPE	FR-A024 EIBUN TORISETU
CODE	1A2-G24

# MEMO

## Revisions

- The manual number is given on the bottom left of the back cover.

Print data	*Manual number	Revision		
Jul., 1994	IB (NA) 66522-A	First edition		
Sep., 1995	IB (NA) 66522-B	Revisions due to changes in specifications		
Jan., 1997	IB (NA) 66522-C	<table border="1"><tr><td><b>Additions</b></td></tr><tr><td><ul style="list-style-type: none"><li>•Wiring procedures (Page 17)</li><li>•Power harmonic guidelines (Japan) (Page 114)</li><li>•Selecting the Rated Sensitivity Current for the Earth Leakage Circuit Breaker (Page 130)</li><li>•EMC Directive-compliant noise filter (Page 140, 141)</li><li>•High power factor converter (Page 142, 143)</li><li>•Instructions for compliance with the European Directives</li><li>•Instructions for compliance with the UL Standard</li><li>•WARRANTY</li></ul></td></tr></table>	<b>Additions</b>	<ul style="list-style-type: none"><li>•Wiring procedures (Page 17)</li><li>•Power harmonic guidelines (Japan) (Page 114)</li><li>•Selecting the Rated Sensitivity Current for the Earth Leakage Circuit Breaker (Page 130)</li><li>•EMC Directive-compliant noise filter (Page 140, 141)</li><li>•High power factor converter (Page 142, 143)</li><li>•Instructions for compliance with the European Directives</li><li>•Instructions for compliance with the UL Standard</li><li>•WARRANTY</li></ul>
<b>Additions</b>				
<ul style="list-style-type: none"><li>•Wiring procedures (Page 17)</li><li>•Power harmonic guidelines (Japan) (Page 114)</li><li>•Selecting the Rated Sensitivity Current for the Earth Leakage Circuit Breaker (Page 130)</li><li>•EMC Directive-compliant noise filter (Page 140, 141)</li><li>•High power factor converter (Page 142, 143)</li><li>•Instructions for compliance with the European Directives</li><li>•Instructions for compliance with the UL Standard</li><li>•WARRANTY</li></ul>				



**MITSUBISHI ELECTRIC CORPORATION**

HEAD OFFICE: MITSUBISHI DENKI BLDG. MARUNOUCHI TOKYO 100

TYPE	FR-A024 EIBUN TORISETU
CODE	1A2-G24