

STANDARD PARAMETER SET

Par.	Description	Range	Default	Explanations	Set to
P-01	Maximum speed	P-02 to 5*P-09 (max 500Hz)	50Hz	Maximum speed limit - Hz or rpm. See P-10	
P-02	Minimum speed	0 to P-01 (max 500Hz)	0Hz	Minimum speed limit - Hz or rpm. See P-10	
P-03	Accel ramp time (s)	0 to 3,000s	5s	Acceleration ramp time from 0 to base speed (P-9) in seconds	
P-04	Decel ramp time (s)	0 to 3,000s	5s	Deceleration ramp time from base speed (P-9) to 0 in seconds	
P-05	Stop mode select	0: 2: Ramp stop 1: Coast to stop	0	If the supply is lost and P-05=0 then the drive will try to continue running by reducing the speed of the load using the load as a generator. If P-05=2, the drive ramps at P-07 to stop.	
P-06	V/f characteristic	0: Constant torque, INDUSTRIAL 1: Pump/fan, HVAC	0	Either V = kf (linear) or V = kf ² (pumps / fans with HVAC rating). Note when P-06 is set to 1 the ramps are automatically set to 60 s.	
P-07	Fast stop (s)	0.0 to 25s. (Disabled when 0.0s)	0.0s	Deceleration ramp time after mains loss (P-05 = 0 or 2) or when fast stop activated (see P-19). When P-05 = 2 and P-07 = 0, activating the fast stop disables the drive without braking (effectively coasting to stop).	
P-08	Motor rated current	25% -100% of drive current rating	Drive rating	Rated (nameplate) current of the motor (Amps). In HVAC (P-06 = 1) mode, the rated motor current limit is increased, allowing P-08 to be set to a higher level	
P-09	Motor rated frequency	25Hz to 500Hz	50 Hz	Rated (nameplate) frequency of the motor. Changing P-09 resets P-02, P-10, P-26 & P-28 to 0, & P-01=P-09.	
P-10	Motor rated speed	0, P-09*12 to P-09*60 eg for 50Hz motor, range is 600 to 3000 rpm	0	When non-zero, speed is displayed in rpm in parameters P-01, P-02, P-20...P-23, P-27 and P-28	
P-11	Voltage boost	0 to 25% of max output voltage	3%	Applies an adjustable boost to the Optidrive voltage output at low speed to assist with starting 'sticky' loads. For continuous applications at low speed use a forced ventilated motor.	
P-12	Terminal or Keypad control	0: Terminal control 1: Keypad control - fwd only 2: Keypad control - fwd and rev 3: Terminal control 4: Not used	0 (Terminal control)	When P-12 = 2, the keypad START key toggles between forward and reverse. When stopped, target speed can be accessed / changed using the STOP & ▲, ▼ buttons. 3: Terminal control	
P-13	Trip log	Last four trips stored	Read only	Most recent 4 trips stored in order of occurrence, ie on entry, display shows most recent first. Press ▲ or ▼ to step through all four	
P-14	Extended menu access	Code 0 to 9999	0	Set to "101" (default) for extended menu access. Change code in P-37 to prevent unauthorised access to the Extended Parameter Set	

EXTENDED PARAMETER SET

Par.	Description	Range	Default	Explanations	Set to
P-15	Motor rated voltage	230V product: 40V to 250V 400V product: 40V to 500V	0V 400V	When P-15 is non-zero, the applied motor voltage is controlled and scaled so that the specified voltage is achieved at rated freq (P-09)	
P-16	Analog input format (V / mA)	Voltage: 0-10V, 10-0V, -10-10V Current: 4-20mA, 0-20mA, 20-4mA	0-10V	Analog input format (on terminal 6). Set to "-10 -10" for bipolar analog input	
P-17	Effective Power stage Switching frequency	8, 16, 32 kHz (Sizes 1, 2) 4, 8, 16 kHz (Sizes 3, 4) 4, 8 kHz (Sizes 5, 6)	16 kHz 4 kHz 4 kHz	Effective power stage switching frequency. Improvements in acoustic noise and output current waveform occur with increasing switching frequency at the expense of increased losses within the drive	
P-18	Relay output function	0: Drive enabled 1: Drive healthy 2: At set speed 3: Speed > zero 4: Motor at max speed (P-01) 5: Motor overload (current > P-08)	1: (Drive healthy)	Relay output function. Contacts closed if selected condition is true. When P-18= 3, (zero speed), the relay contacts close when the output frequency is greater than 5% of base frequency. The drive is in overload when the motor current exceeds P-08	
P-19	Digital inputs function select	0 to 12	0	Defines function of digital inputs (see also P-16 and Digital Inputs table)	
P-20	Preset / Jog speed 1	-P-01 (reverse) to P-01	50Hz	Defines Preset / Jog speed 1	
P-21	Preset / Jog speed 2	-P-01 (reverse) to P-01	0 Hz	Defines Preset / Jog speed 2	
P-22	Preset / Jog speed 3	-P-01 (reverse) to P-01	0 Hz	Defines Preset / Jog speed 3	
P-23	Preset / Jog speed 4	-P-01 (reverse) to P-01	0 Hz	Defines Preset / Jog speed 4	
P-24	Slip compensation	20% to 250%	100%	Slip correction factor. Value defines the percentage of the internally calculated slip compensation value to be applied. See also P-10.	
P-25	Analog output function	(A) 0: Motor Speed 1: Motor current (D) 2: Drive enabled 3: Set speed	0	Analog output select. When P-25 = 0 then 10V = 100% of P-01, or if P-25 =1 then 10V = 200% of P-08. P-25 = 2 or 3 gives a 10V digital output.	
P-26	V/f characteristic adjustment factor	20% to 250%	100%	Used with P-29 to adjust the V/f characteristic. When P-26 > 100%, motor voltage is increased, when P-26 < 100%, voltage is reduced	
P-27	Skip freq / speed	0 to P-01 (max)	0 Hz	Centre point for skip frequency band. The skip frequency band defined by P-27, P-28 is mirrored around zero for negative speeds.	
P-28	Skip freq / speed band	0 to 100% of rated speed/freq. P-09	0 Hz	Width of skip frequency band, the centre of which is defined by P-27.	
P-29	V/f characteristic adjustment frequency	0 to base frequency (P-09) (Function disabled when set to zero)	0 Hz	Sets the frequency at which the V/f adjustment factor in P-26 has full effect. This allows the motor voltage applied at the frequency in P-29 to be increased or decreased by the factor set in P-26.	
P-30	Drive start mode	Edge-r: Close Digital input 1 after power up to start drive Auto-0: drive runs whenever Digital input 1 closed. Auto-1..4: as Auto-0, except 1..4 Attempts to restart after a trip	Auto-0	When set to Edge-r, if drive is powered up with Digital Input 1 closed (enabled), drive will not run. The switch must be opened & closed after power up or after a clearing a trip for the drive to run. When set to Auto-0, drive will run whenever digital input 1 is closed (if not tripped). Auto-1..4 makes 1..4 attempts to automatically restart after a trip (25s between attempts). If fault has cleared drive will restart. Drive must be powered down, reset on the keypad or reset by re-enabling the drive to reset auto-reset counter. When P-12 is set to 1 or 2, P-30 changes automatically to Edge-r.	
P-31	DC injection voltage	0.1 to 20% of max voltage	10%	If P-05 selection is 'ramp to stop', P-31 sets the level of DC braking applied when the ramp reaches zero	
P-32	DC injection braking time	0 to 250s	0s	If P-05 selection is 'ramp to stop', P-32 sets the duration of DC braking applied when the ramp reaches zero	
P-33	DC injection on enable	0: Inactive 1: Enabled	0	When 1, DC injection is applied whenever the drive is enabled	
P-34	External Brake Resistor	0: No brake resistor fitted 1: Optidrive braking resistor 2: Customer specified resistor	0	Activates the internal braking transistor. When P-34 =1 the braking resistor is protected by the drive against overload. When P-34 = 2, a thermal overload relay must be used to protect the resistor and drive.	
P-35	Speed reference scaling factor (analog or digital)	1% to 500%	100%	Scales the analog input at control terminal 6 up or down, or the digital reference in keypad (or Slave) mode up or down (see P-12).	
P-36	Drive address (s-comms)	0 to 63	1	Distinct drive address for serial comms. 0 = comms disabled	
P-37	Access code definition	0 to 9999	101	Defines Extended Parameter Set access code, P-14	
P-38	Parameter access lock	0: Parameters can be changed, auto-saved on power down 1: Parameter changes not saved on power down 2: Read-only. No changes allowed.	0 (write access and auto-save are enabled)	Controls user access to parameters. When P-38 = 0, all parameters can be changed and these changes will be stored automatically. When P-38 = 1, changes may be made but these will not be stored when the Optidrive powers down. When P-38 = 2, parameters are locked and cannot be changed thus preventing unauthorised access.	
P-39	Hours run meter	0 to 99999 hours	Read only	Not affected by reset-to-default command	
P-40	Drive identifier	Drive rating / Software version	Read only	Drive rating, drive type and software version codes	

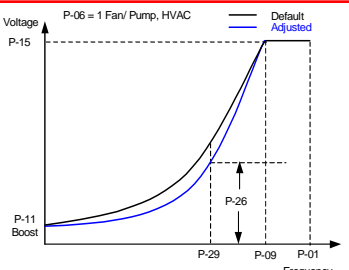
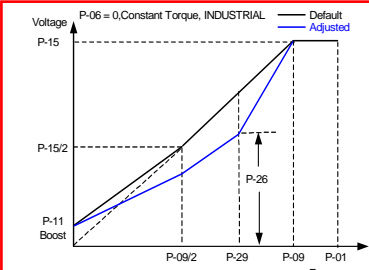

Voltage / Frequency (V/f) Characteristic

The V/f characteristic is defined by several parameters as shown.

Reducing the voltage at a particular frequency reduces the current in the motor and hence the torque and power; for fans and certain types of pump which require very little torque at low speed use fan/ pump curve, P-06=1, HVAC.

The V/f curve can be further modified by using P-26 and P-29, where P-26 determines the percentage increase or decrease of the voltage applied to the motor at the frequency specified in P-29. This can be useful if motor instability is experienced at certain frequencies, if this is the case increase or decrease the voltage (P-26) at the speed of instability (P-29).

ENCLOSURE - NON VENTED DIMENSIONS

DRIVE POWER RATING	SEALED UNIT		
	W	H	D
Size 1 0.75kW 200V / 400V	250	300	200
Size 1 1.5kW 200V / 400V	300	400	250
Size 2 1.5kW 200V / 2.2kW 400V	300	400	300
Size 2 2.2kW 200V / 4kW 400V	450	600	300

ENCLOSURE - VENTED DIMENSIONS

DRIVE POWER RATING	VENTED UNIT			FORCE VENTED (WITH FAN)		
	W	H	D	W	H	D
Size 1 (1.5kW)	300	400	150	200	300	150
Size 2 (4kW)	400	600	250	300	400	250
Size 3 (15kW)	600	800	300	400	600	250
Size 4 (22kW)	600	1000	300	600	800	300
Size 4 (37kW)	N/A	N/A	N/A	600	800	300
Size 5 (90kW)	N/A	N/A	N/A	800	1600	300
Size 6 (160kW)	N/A	N/A	N/A	800	2000	300

DIGITAL INPUTS - TERMINAL MODE (P-12 = 0, 3 or 4)

P-19	Input 1 function	Input 2 function	Input 3 function	Additional Information
0	Open: Stop (disable) Closed: Run (enable)	Open: Analog speed reference Closed: Preset / Jog Speed 1	Open: Voltage analog input Closed: Current analog input	The format of the current analog input is defined by P-16, if P-16 is set to 0-10V a 4-20mA format will be assumed when input 3 closed
1	Open: Stop (disable) Closed: Run (enable)	Open: Analog speed reference Closed: Preset / Jog Speed 1 or 2, selected by Digital Input 3	Open: Preset / Jog Speed 1 Closed: Preset / Jog Speed 2	
2	Open: Stop (disable) Closed: Run (enable)	Digital Input 2 Open + Digital Input 3 Open = Preset / Jog Speed 1 Digital Input 2 Closed + Digital Input 3 Open = Preset / Jog Speed 2 Digital Input 2 Open + Digital Input 3 Closed = Preset / Jog Speed 3 Digital Input 2 Closed + Digital Input 3 Closed = Preset / Jog Speed 4	Open: Analog speed reference Closed: Preset / Jog Speed 1	Analog voltage input used as 4 th digital input: if 5V<Vin<30V then preset speed is reversed
3	Open: Stop (disable) Closed: Run (enable)	External trip input: Open: TRIP; Closed: no trip.	Open: Analog speed reference Closed: Preset / Jog Speed 1	
4	Open: Stop (disable) Closed: Run (enable)	Open: Run forward Closed: Run reverse	Open: Analog speed reference Closed: Preset / Jog Speed 1	
5	Open: Fwd Stop (disable) Closed: Fwd Run (enable)	Open: Reverse Stop (disable) Closed: Reverse Run (enable)	Open: Analog speed reference Closed: Preset / Jog Speed 1	Wire break mode. Fast stop (P-07) activated when input 1 & input 2 closed at same time.
6	Open: Stop (disable) Closed: Run (enable)	Open: Run forward Closed: Run reverse	External trip input: Open: TRIP; Closed: no trip.	
7	Open: Fwd Stop (disable) Closed: Fwd Run (enable)	Open: Reverse Stop (disable) Closed: Reverse Run (enable)	External trip input: Open: TRIP; Closed: no trip.	Wire break mode. Fast stop (P-07) activated when input 1 & input 2 closed at same time.
8	Open: Stop (disable) Closed: Run (enable)	Open: Run forward Closed: Run reverse	Open: Preset / Jog Speed 1 Closed: Preset / Jog Speed 2	
9	Open: Fwd Stop (disable) Closed: Fwd Run (enable)	Open: Reverse Stop (disable) Closed: Reverse Run (enable)	Open: Preset / Jog Speed 1 Closed: Preset / Jog Speed 2	Wire break mode. Fast stop (P-07) activated when input 1 & 2 closed together. Analog input is 4 th digital input. When Vin > 5V, preset speeds 3 / 4 selected.
10	Normally Open (N.O.) Momentary close to run fwd	Normally Closed (N.C.) Momentary open to Stop (disable)	Open: Analog speed reference Closed: Preset / Jog Speed 1	
11	Normally Open (N.O.) Momentary close to run fwd	Normally Closed (N.C.) Momentary open to Stop (disable)	Normally Open (N.O.) Momentary close to run reverse	
12	Open: Stop (disable) Closed: Run (enable)	Close to run Open to activate fast stop (P-07)	Open: Analog speed reference Closed: Preset / Jog Speed 1	Fast stop (P-07) activated when input 2 opened

OPTIDRIVE OPTIONS

- The following additional products are available:
- EMC filters to meet EN 61000-6-3 & EN 61000-6-4 for conducted emissions
 - Optiwand: multi-language LCD IR remote control and programming unit
 - Optistor: PC based program for storing, editing and printing parameter sets
 - Braking resistor (Sizes 2 to Size 6).
 - RS232/485 serial communications interface unit (Optibus protocol)
 - Optidrive Fieldbus Gateway for connection to Profibus DP, DeviceNet, & Modbus communication systems
 - Optiport: remote keypad and LED display, with scalable display and PI for feedback control systems
 - Optilink: fibre optic cable used to connect drive networks.
 - Dual relay output and dual analog input
 - Enclosed (IP55) Optidrive
 - Optidrive Coolplate with heatsink removed for mounting to a cooled surface
 - Optidrive sizes 4, 5 & 6 for 525V supplies
 - Optidrive for control of single phase motors

DIGITAL INPUTS - KEYPAD MODE (P-12 = 1 or 2)

P-19	Input 1 function	Input 2 function	Input 3 function	Additional Information
0,1,2,4, 5,8,12	Open: Stop (disable) Closed: Run (enable)	Closed: remote up pushbutton Open: TRIP; Closed: no trip	Closed: remote down pushbutton Open: Keypad speed reference Closed: Preset / Jog Speed 1	Closing inputs 2 & 3 at same time starts the drive. If P-12=2, closing inputs 2 & 3 reverses drive.
3	Open: Stop (disable) Closed: Run (enable)	External trip input: Open: TRIP; Closed: no trip	Open: Keypad speed reference Closed: Preset / Jog Speed 1	Allows use of motor thermistor in keypad mode. Speed reference is set by pushbuttons.
6	Open: Stop (disable) Closed: Run (enable)	Open: Run forward Closed: Run reverse	External trip input: Open: TRIP; Closed: no trip	Allows use of motor thermistor in keypad mode. Speed reference is set by pushbuttons.
7	Open: Stop (disable) Closed: Run (enable)	Open: Reverse Stop (disable) Closed: Reverse Run (enable)	External trip input: Open: TRIP; Closed: no trip	Allows use of motor thermistor in keypad mode. Fast stop (P-07) activated when input 1 & input 2 closed at same time.

Digital inputs are active high (positive logic) - active >8 volts, maximum 30 volts

TO CLEAR A TRIP CONDITION

Remove the condition which caused the trip and press the STOP key or re-enable the drive. The drive will restart according to the mode selected by P-30. If the motor is stopped and the display shows STOP, there is no fault; the drive output is disabled and the drive is ready to run.

TROUBLESHOOTING

Fault Code	What has happened	What to do
P-deF	Default parameters loaded	Press STOP key, drive is ready to configure for particular application
O-I	Over current on drive output. Excess load on the motor. Over temperature on the heatsink	Motor at constant speed: investigate overload or malfunction. Motor starting: load stalled or jammed. Check for star-delta motor wiring error. Motor accelerating/decelerating: The accel/decel time too short requiring too much power. If P-03 or P-04 cannot be increased, a bigger drive is needed
O-Uolt	Over voltage on DC bus	Supply problem, or increase decel ramp time P-04.
U-Uolt	Under voltage on DC bus	This occurs routinely when power is switched off. If it occurs during running, check power supply voltage.
l.t-trP	The drive has tripped on overload after delivering greater than 100% load for a period of time.	Check to see when the decimal points are flashing (drive in overload) and either decrease acceleration rate or load. Check cable length is within specification.
th-Flt	Faulty thermistor on heatsink.	Refer to your IDL Authorised Distributor.
E-trIP	External trip (on dig. input 2 or 3)	External trip on digital input - see P-19 (motor thermistor?)
EE-F	EEPROM fault. Parameters not saved, defaults reloaded.	Try again. If problem recurs, refer to your IDL Authorised Distributor.
PS-Trp	Internal power stage fault	Check wiring to motor, look for ph-ph or ph-Earth short circuit. Check drive ambient temp, additional space or cooling needed? Check drive is not forced into overload.
O-t	Heatsink over temperature	Check drive ambient temp. Additional space or cooling needed?
lin-F	Current analog input out of range	Check input current in range defined by P-16

FURTHER INFORMATION
The Website, www.invertek.co.uk, contains:
• General information, inc Product & Options Manuals
• App notes & S/ware upgrade files
• Company and IDL authorised dealer information

OPTIDRIVE DIMENSIONS - Control terminal torque settings : 0.5Nm

	Size 1	Size 2	Size 3	Size 4	Size 5	Size 6	S6 Input Choke
Length/mm	155	260	260	520	1045	280	280
Depth/mm	80	100	171	340	340	280	280
Depth/mm	130	175	175	220	330	280	280
Weight/kg	1.1	2.6	5.3	28	68	25	25
A / mm	72	92	163	320	66	160	-
B / mm	72	4	-	9.5	-	-	-
C / mm	25	-	-	50	-	-	-
D / mm	105	210	210	420	945	105	-
Fixings	2 * M4	4 * M4	-	4 * M8	-	-	-
Terminal torque setting	1 Nm	1 Nm	1 Nm	4 Nm	8 Nm	8 Nm	8Nm

ELECTRICAL DATA

OPTIDRIVE SIZE 1	Model	OD-xxxx-IN	12037	12075	12150	14075	14150
Supply voltage	+/ - 10%	220-240	220-240	220-240	220-240	220-240	220-240
Phases		1	1	1	1	1	1
Motor output rating	kW	0.37	0.75	1.5	0.75	1.5	1.5
Fuse or MCB rating	HP	0.5	1.0	2.0	1.0	2.0	2.0
Output current	A	2.3	4.3	7.0	2.2	4.1	4.1
Fuse or MCB rating	A	10	10	20	5	10	10
Max ambient temperature	°C 8kHz	50	50	50	50	50	50
	°C 16kHz	50	40	40	40	40	40
	°C 32kHz	50	30	30	30	30	30
Motor cable size, Cu 75C	mm ²	1.5	1.5	1.0	1.0	1.5	1.5
Max motor cable length	m	100	100	50	100	100	100
Min brake resistor	Ω	33	22	47	47	47	33
OPTIDRIVE SIZE 2 (INTEGRAL BRAKING TRANSISTOR)	Model	OD-xxxx-IN	22150	22220	24075	24150	24220
Supply voltage	+/ - 10%	220-240	220-240	220-240	220-240	220-240	220-240
Phases		1 or 3	1 or 3	1 or 3	1 or 3	1 or 3	1 or 3
Motor output rating	kW	1.5	2.2	0.75	1.5	2.2	4
Fuse or MCB rating	HP	2	3	1	2	3	5.5
Output current	A	7	10.5	2.2	4.1	5.8	9.5
Fuse or MCB rating	A	20	30	5	10	10	16
Max ambient temperature	°C 8kHz	50	50	50	50	50	50
	°C 16kHz	50	40	50	40	50	40
	°C 32kHz	40	30	50	30	40	40
Motor cable size, Cu 75C	mm<						

OPTIDRIVE USER GUIDE



SAFETY NOTICES

It is the responsibility of the installer to ensure that the equipment or system into which the product is incorporated complies with the EMC legislation of the country of use. Within the European Union, equipment into which this product is incorporated must comply with 89/336/EEC, Electromagnetic Compatibility.

WARNING!
The level of integrity offered by the Optidrive control functions – for example stop/start, forward/reverse and maximum speed, is not sufficient for use in safety-critical applications without independent channels of protection. All applications where malfunction could cause injury or loss of life must be subject to a risk assessment and further protection provided where needed. Within the European Union, all machinery in which this product is used must comply with Directive 89/392/EEC, Safety of Machinery. In particular, the electrical equipment should comply with EN60204-1.

CAUTION

- Carefully inspect the Optidrive before installation to ensure it is undamaged
- Store the Optidrive in its box until required. Storage should be clean and dry Temp. Range -40°C to +60°C
- Install the Optidrive on a flat, vertical, flame-resistant vibration-free mounting within a suitable enclosure, according to EN60529 if specific Ingress Protection ratings are required. Installation required in a pollution degree 2 environment.
- Flammable material should not be placed close to the drive
- The entry of conductive or flammable foreign bodies should be prevented
- Max. ambient temperature 50°C, min. -5°C. Refer to table on reverse side.
- Relative humidity must be less than 95% (non-condensing).
- The Optidrive is suitable for use on a circuit capable of delivering not more than 5KA (50Hp) / 10KA (51-200HP) symmetrical amperes, 480V maximum.

GENERAL TECHNICAL DATA

- Supply frequency 48 to 62 Hz.
- Max. permissible 3-phase supply imbalance 3%.
- Max. ambient temperature 50 °C.
- Max. altitude 2000 m.
- Derate above 1000 m, 1% / 100 m.
- Derate output current 5%/°C above max. ambient temp up to 55°C
- 1 x 1 protection above 100% output current.
- 150% overload protection for 60 sec.
- 175% overload allowable for 2 sec.
- Storage temperature -40 to +60 °C

WARRANTY

All Invertek Drives Ltd (IDL) products carry a 2-year warranty, valid from the date of manufacture. Complete Warranty Terms and Conditions are available upon request from your IDL Authorised Distributor.

WARNING !

- Optidrive should be installed only by qualified electrical persons and in accordance with local and national regulations and codes of practice. The Optidrive has an Ingress Protection rating of IP20. For higher IP ratings, use a suitable enclosure.
- Electric shock hazard!** Disconnect and ISOLATE the Optidrive before attempting any work on it. High voltages are present at the terminals and within the drive for up to 10 minutes after disconnection of the electrical supply
- Where supply to the drive is through a plug and socket connector, do not disconnect until 10 minutes have elapsed after turning off the supply
- Ensure correct earthing connections
- The earth cable must be sufficient to carry the maximum supply fault current which normally will be limited by the fuses or MCB

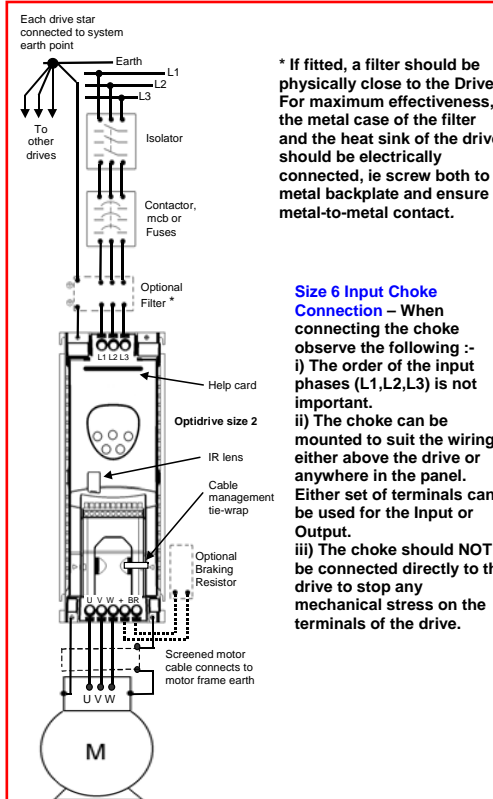

* If fitted, a filter should be physically close to the Drive. For maximum effectiveness, the metal case of the filter and the heat sink of the drive should be electrically connected, ie screw both to a metal backplate and ensure metal-to-metal contact.

Size 6 Input Choke Connection

When connecting the choke observe the following :-

- The order of the input phases (L1,L2,L3) is not important.
- The choke can be mounted to suit the wiring, either above the drive or anywhere in the panel. Either set of terminals can be used for the Input or Output.
- The choke should NOT be connected directly to the drive to stop any mechanical stress on the terminals of the drive.

ELECTRICAL INSTALLATION

Connect drive according to diagram (above), ensuring that motor terminal box connections are correct (see diagram, below). Refer to the **ELECTRICAL DATA** overleaf for the sizes of cabling and wiring. It is recommended that the power cabling should be 3-core or 4-core PVC-insulated screened cable, laid in accordance with local industrial regulations and codes of practice.

OPERATION – USING THE KEYPAD MANAGING THE KEYPAD

When the drive is delivered from the factory, only the Standard Parameter Set (see overleaf) is accessible. To access the Standard Parameter Set, press the Navigate key ⇄ for >1 sec.

- Scroll through P-01 to P-14 (and roll over to P-01) by pressing ▲ or ▼
- To display the parameter value, press ⇄
- To edit the parameter value, press ▲ or ▼
- To return to the parameter number, press ⇄
- To store a value and / or exit from edit mode, press ⇄ for >1 sec or press no button for >20 sec.

To access the Extended Parameter Set, set P-14 = 101 and press ⇄

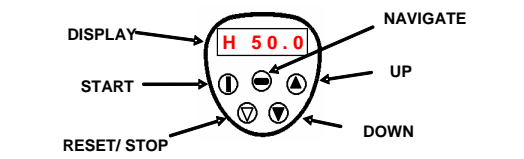

NOTE To restrict unauthorised access, make P-37 = any value from 0 to 9999.

- When in the Extended Parameter Set (except P-00), the display will revert to normal if no button is pressed for >20 sec.

TO RESTORE ALL DEFAULT VALUES,

stop the drive and when display shows StOP, press and hold the ▲, ▼ and STOP keys simultaneously for 1 second. The display will show P-dEF. Access code P-37 will revert to 101 but the hours-run meter P-39 is not affected. Press STOP to resume normal operation.

CONTROL TERMINAL BLOCK - Default Status

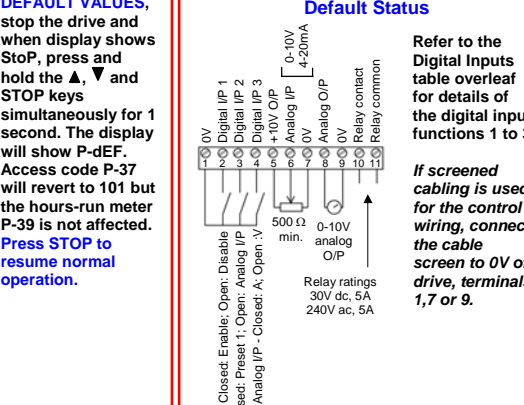

Refer to the Digital Inputs table overleaf for details of the digital input functions 1 to 3

If screened cabling is used for the control wiring, connect the cable screen to 0V of drive, terminals 1,7 or 9.

OPERATING IN KEYPAD MODE

Set P-12 = 1 (this allows the Optidrive to be controlled from the keypad):

- Enable the drive by closing digital input 1. The display will show StOP.
- Press the START key. The display shows H 0.0.
- Press ▲ to increase speed
- The drive will run forward, increasing speed until ▲ is released. **CAUTION:** the rate of acceleration is controlled by the setting of P-03, check this before starting.
- Either Press ▼ to decrease speed
- The drive will decrease speed until ▼ is released. The rate of deceleration is limited by the setting in P-04
- Or Press the STOP key. The drive will decelerate to rest at the rate set in P-04.
- The display will finally show StOP at which point the drive is disabled
- To preset a target speed prior to enable press the stop key whilst the drive is stopped. The display will show the target speed, use the ▲ and ▼ to adjust as required then press the Stop key to return the display to StOP. Pressing the START key will start the drive accelerating to the target speed.

With P-12 set to 2:

- Press the START key. The display changes to H 0.0.
- Press ▲ to increase speed
- The drive will run forward, increasing speed until ▲ is released. Acceleration is limited by the setting in P-03. The maximum speed is the speed set in P-01.
- Press the START key again. The motor will reverse its direction of rotation.

The operation of the keypad can be duplicated using remote pushbuttons connected to the control terminals, see Application Note AN21. In this mode, if P30 is set to Auto-0..4, then the drive will run as soon as the drive enable is applied (terminal 1 & 2 is closed).

TO SAVE CHANGES

to Parameter settings, switch the power supply off and wait for the drive to power down (screen blank) before switching on. NOTE that this assumes P-38 = 0 (default). If P-38 = 1, changes are not saved.

User Guide

All rights reserved. No part of this User Guide may be reproduced or transmitted in any form or by any means, electrical or mechanical including photocopying, recording or by any information storage or retrieval system without permission in writing from the publisher.

Copyright Invertek Drives Ltd © 2005

The manufacturer accepts no liability for any consequences resulting from inappropriate, negligent or incorrect installation, or adjustment of the optional operating parameters of the drive or from mismatching of the drive to the motor.

The contents of this User Guide are believed to be correct at the time of printing. In the interests of a commitment to a policy of continuous improvement, the manufacturer reserves the right to change the specification of the product or its performance or the contents of the User Guide without notice.

SAFETY

This variable speed drive product (Optidrive) is intended for professional incorporation into complete equipment or systems. If installed incorrectly it may present a safety hazard. The Optidrive uses high voltages and currents, carries a high level of stored electrical energy, and is used to control mechanical plant that may cause injury. Close attention is required to system design and electrical installation to avoid hazards in either normal operation or in the event of equipment malfunction. System design, installation, commissioning and maintenance must be carried out only by personnel who have the necessary training and experience. They must read carefully this safety information and the instructions in this Guide and follow all information regarding transport, storage, installation and use of the Optidrive, including the specified environmental limitations. Please read the **IMPORTANT SAFETY INFORMATION** below, and all **Warning** and **Caution** boxes elsewhere.

SAFETY NOTICES

WARNING is given where there is a hazard that could lead to injury or death of personnel
CAUTION is given where there is a hazard that could lead to damage to equipment

WARNING !

- The STOP function does not remove potentially lethal high voltages. ISOLATE the drive and wait 10 minutes before starting any work on it
- Parameter P-01 can be set to operate the motor at up to 60,000 rpm, hence use this parameter with care
- If it is desired to operate the drive at any frequency/speed above the rated speed (P-09/ P-10) of the motor, consult the manufacturers of the motor and the driven machine about suitability for over-speed operation
- The fan (if fitted) to the heatsink of the Optidrive starts automatically when the heatsink temperature reaches approximately 40°C. When the heatsink is at room temperature the fan will be stopped.

CAUTION

- Ensure that the supply voltage, frequency and no. of phases (1 or 3 phase) correspond to the rating of the Optidrive as delivered.
- An isolator should be installed between the power supply and the drive.
- Never connect the mains power supply to the Output terminals U,V,W.
- Protect the drive by using slow-blowing HRC fuses or MCB located in the mains supply of the drive
- Do not install any type of automatic switchgear between the drive and the motor
- Wherever control cabling is close to power cabling, maintain a minimum separation of 100 mm and arrange crossings at 90°
- Ensure that screening or armouring of power cables is effected in accordance with the connections diagram below
- Ensure that all terminals are tightened to the appropriate torque (see table)

IMPORTANT SAFETY INFORMATION

Optidrive hardware and software are designed and tested to a high standard and failures are unlikely.

Electromagnetic Compatibility (EMC)

Optidrive is designed to high standards of EMC. EMC data is provided in a separate EMC Data Sheet, available on request. Under extreme conditions, the product might cause or suffer disturbance due to electromagnetic interaction with other equipment. It is the responsibility of the installer to ensure that the equipment or system into which the product is incorporated complies with the EMC legislation of the country of use. Within the European Union, equipment into which this product is incorporated must comply with 89/336/EEC, Electromagnetic Compatibility.

When installed as recommended in this User Guide, the radiated emissions levels of all Optidrives are less than those defined in the Generic radiated emissions standard EN61000-6-4. When correctly fitted with an Optifilter (Mains filter), the conducted emission levels are less than those defined in the Generic radiated emissions standard EN61000-6-3 (class B) for screened cable lengths of < 5m and with EN61000-6-4 (class A) for screened cable lengths of < 25m.

STANDARDS CONFORMITY

The Optidrive conforms with the following standards

- CE marked for low voltage directive
- UL508C Power conversion equipment
- IEC 664-1 Insulation coordination for equipment within low voltage systems
- EN61800-3 Adjustable Speed electrical power drive systems – Part 3 (EMC)
- EN 61000-6 / -2, -3, -4 Generic Immunity / Emissions standards (EMC)

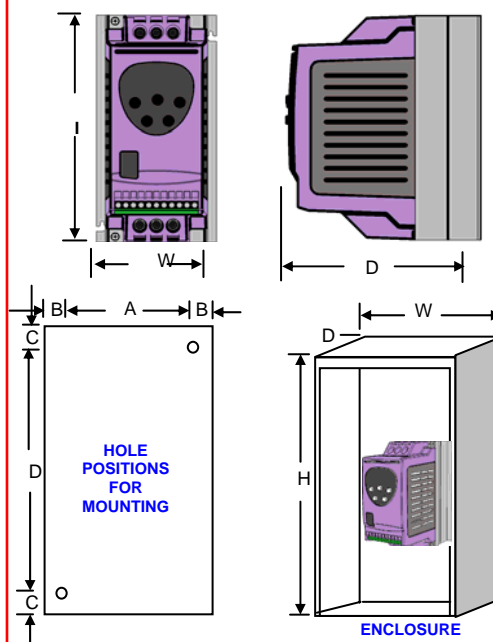

MECHANICAL INSTALLATION

Optidrives can be installed side-by-side with their heatsink flanges touching. This gives adequate ventilation space between them. If the Optidrive is to be installed above another drive or any other heat-producing device, the minimum vertical spacing is 100mm. The enclosure should either be force-ventilated or large enough to allow natural convection (allow 0.1 m³ per kW of drive rating).

GROUNDING (EARTHING)

The ground terminal of each Optidrive should be individually connected DIRECTLY to the site earth (ground) busbar (through the filter if installed) as shown. Optidrive ground connections should not loop from one drive to another, or to, or from any other equipment. Ground loop impedance must conform to local industrial safety regulations. To meet UL regulations, UL approved ring crimp terminals should be used for all earth wiring connections.

OPERATION – BASICS + GETTING STARTED MOTOR TERMINAL BOX CONNECTIONS

Motors are connected in either STAR or DELTA. The motor rating plate will indicate the voltage rating for the method of connection, ensure that this matches the Optidrive operating voltage.

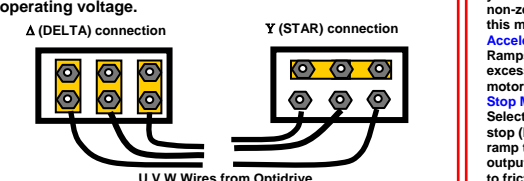

EASY START-UP

When delivered, the Optidrive is in the default state, meaning that it is set to operate in terminal mode and all parameters (P-xx) have the default values as shown overleaf.

- Connect a control switch between the control terminals 1 and 2.
- Connect a potentiometer (500 Ω min to 10 kΩ max) between terminals 5 and 7, and wiper to terminal 6.
- Set the control switch between pins 1 and 2 open so that the drive is 'disabled'.
- With the potentiometer set to zero, switch on the supply to the drive. The display will show StOP.
- Close the control switch, terminals 1-2. The drive is now 'enabled' and the output frequency/speed are controlled by the potentiometer. The display shows zero speed in Hz (H 0.0) with the potentiometer turned to minimum.
- Turn the potentiometer to maximum. The motor will accelerate to 50Hz (the default value of P-01) under the control of the accelerating ramp time P-03. The display shows H 50.0 (50Hz) at max speed.
- To display motor current (A), briefly press the Navigate key ⇄.
- Press ⇄ again to return to speed display.
- To stop the motor, either turn the potentiometer back to zero or disable the drive by opening the control switch (terminals 1-2).

If the enable/disable switch is opened the drive will decelerate to stop at which time the display will show StOP. If the potentiometer is turned to zero and the enable/disable is closed the display will show 0.0Hz, if left like this for 20 seconds the drive will go into standby mode, display shows Stndby, waiting for a speed reference.

SIMPLE PARAMETER ADJUSTMENTS

The factory-set default parameter values may give satisfactory performance, however certain adjustments may be beneficial. Maximum and Minimum Speeds P-01 & P-02

Set P-01 to the maximum speed and P-02 to the minimum speed for your application. These limits are mirrored for negative speeds. If a non-zero minimum speed is set in P-02, the motor will ramp (P-03) to this minimum speed as soon as the drive is enabled.

Acceleration and Deceleration P-03 & P-04

Ramps which are too short will cause the drive to deliver currents in excess of full load current and may result in it tripping out or the motor stalling

Stop Mode P-05

Select method of stopping required when drive is disabled. Ramp to stop (P-05 = 0) decelerates the motor at the rate set by deceleration ramp time P-04. Freewheel/ Coast to stop (P-05=1) disables the drive output immediately, allowing the motor to decelerate naturally due to friction or under the control of a mechanical brake

Torque/Speed Characteristic P-06

Certain loads such as fans and centrifugal pumps need very little torque at low speed. Set P-06=1 to reduce power loss at low speeds for this load type

Rated Current, Rated Frequency and Rated Speed P-08, P-09, P-10.

Parameters P-08 and P-09 should be set to correspond with the rated current and frequency shown on the motor rating plate. Parameter P-10 is optional. If this parameter is set to zero (default state), speed will be displayed in Hz; if speed indication is required in rpm, enter the motor rated speed (speed at full load) from the motor rating plate.

Voltage Boost P-11

Any load which is 'sticky' to start will benefit from a voltage boost on starting. P-11 permits a boost of up to 25% of full motor voltage to be applied.

NOTE: Use of this parameter increases motor heating at low speeds

Terminal or Keypad Control P-12

Terminal control (P-12=0) is used when the drive needs to be controlled from some remote point, such as a control panel interface or machine system.

Keypad control (P12=1 or 2) is used for local, manual control and commissioning

Extended Parameter Set P15 to P-40 and P-00

The Extended Parameter Set is intended for use by specialist drives engineers and technicians and will not generally be required for simple applications.

PARAMETER ZERO

- Provides a read only window into the motor control software allowing key internal values to be viewed. This is useful for following signals through the drive control system when troubleshooting.
- Access, scroll, change and exit are as for any other parameter. The selected variable is at the left hand side of the display.
- There are 9 different windows listed below:
 - Unscaled analog input (%)
 - Speed ref. via scaled analog input (Hz)
 - Pre-ramp speed ref. (Hz)
 - Post-ramp speed ref. (Hz)
 - Not used
 - Stator field frequency (Hz)
 - Applied motor voltage (V)
 - DC bus voltage (V)
 - Internal thermistor (NTC) value