

**⚠ WARNING / ATENCION / ATENÇÃO**  
- REMOVE TERMINAL COVER ONLY 10MIN. AFTER POWER HAS BEEN DISCONNECTED.  
- READ THE INSTRUCTION MANUAL.  
- SOLAMENTE RETIRE LA TAPA FRONTAL LUEGO DE 10 MIN. DE DESENERGIZADO EL EQUIPO.  
- VER MANUAL DE INSTRUCCIONES.  
- SOMENTE REMOVA A TAMPA FRONTAL 10MIN. APÓS A DESENERGIZAÇÃO.  
- LEIA O MANUAL DE INSTRUÇÕES.

# CFW-11

- User's Guide **Frequency Inverter**
- Guía del Usuario **Convertidor de Frecuencia**
- Manual do Usuário **Inversor de Freqüência**

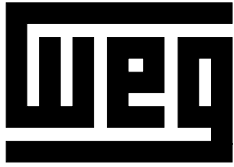



**CFW-11** VECTRUE INVERTER

# FREQUENCY INVERTER MANUAL

**Series:** CFW-11

**Language:** English

**Document:** 10000063093 / 02

Models: 6...105 A / 200...240 V

3,6...88 A / 380...480 V

## Summary of Revisions

---

Revision	Description	Chapter
1	First Edition	-
2	General Revision	-

**CHAPTER 1**  
**Safety Instructions**

1.1 Safety Warnings in the Manual.....	1-1
1.2 Safety Warnings in the Product.....	1-1
1.3 Preliminary Recommendations .....	1-2

**CHAPTER 2**  
**General Instructions**

2.1 About the Manual .....	2-1
2.2 Terms and Definitions.....	2-1
2.3 About the CFW-11 .....	2-4
2.4 Identification Labels for the CFW-11 .....	2-7
2.5 Receiving and Storage .....	2-9

**CHAPTER 3**  
**Installation and Connection**

3.1 Mechanical Installation .....	3-1
3.1.1 Installation Environment.....	3-1
3.1.2 Mounting Considerations.....	3-1
3.1.3 Cabinet Mounting .....	3-4
3.1.4 Access to the Control and Power Terminal Strips.....	3-5
3.2 Electrical Installation .....	3-7
3.2.1 Identification of the Power and Grounding Terminals .....	3-7
3.2.2 Power / Grounding Wiring and Fuses.....	3-8
3.2.3 Power Connections.....	3-12
3.2.3.1 Input Connections .....	3-12
3.2.3.1.1 IT Networks .....	3-12
3.2.3.2 Dynamic Braking.....	3-14
3.2.3.2.1 Sizing the Braking Resistor.....	3-14
3.2.3.2.2 Installation of the Braking Resistor.....	3-16
3.2.3.3 Output Connections .....	3-17
3.2.4 Grounding Connections .....	3-19
3.2.5 Control Connections .....	3-20
3.2.6 Typical Control Connections.....	3-24
3.3 Installation According to the European Directive of Electromagnetic Compatibility .....	3-27
3.3.1 Conformal Installation .....	3-27
3.3.2 Standard Definitions .....	3-28
3.3.3 Emission and Immunity Levels.....	3-29

**CHAPTER 4  
KEYPAD AND DISPLAY**

4.1 Integral Keypad - HMI-CFW11 .....4-1  
4.2 Parameters Organization .....4-4

**CHAPTER 5  
First Time Power-Up and Start-Up**

5.1 Prepare for Start-Up .....5-1  
5.2 Start-Up .....5-2  
    5.2.1 Password Setting in P0000 .....5-2  
    5.2.2 Oriented Start-up .....5-3  
    5.2.3 Setting Basic Application Parameters .....5-5  
5.3 Setting Date and Time .....5-8  
5.4 Blocking Parameters Modification .....5-8  
5.5 How to Connect a PC .....5-9  
5.6 FLASH Memory Module .....5-9

**CHAPTER 6  
Troubleshooting and Maintenance**

6.1 Operation of the Faults and Alarms .....6-1  
6.2 Faults, Alarms, and Possible Causes .....6-2  
6.3 Solutions for the Most Frequent Problems .....6-6  
6.4 Information for Contacting Technical Support .....6-7  
6.5 Preventive Maintenance .....6-7  
    6.5.1 Cleaning Instructions .....6-9

**CHAPTER 7  
Option Kits and Accessories**

7.1 Option Kits .....7-1  
    7.1.1 RFI Filter .....7-1  
    7.1.2 Safety Stop According to EN 954-1 Category 3 (Pending Certification) .....7-1  
    7.1.3 24 Vdc External Control Power Supply .....7-3  
7.2 Accessories .....7-4

**CHAPTER 8  
Technical Specifications**

8.1 Power Data .....8-1  
8.2 Electrical / General Specifications .....8-6  
    8.2.1 Codes and Standards .....8-7  
8.3 Mechanical Data .....8-8  
8.4 Conduit Kit .....8-12

## SAFETY INSTRUCTIONS

This manual provides information for the proper installation and operation of the CFW-11 frequency inverter.

Only trained and qualified personnel should attempt to install, start-up, and troubleshoot this type of equipment.



### 1.1 SAFETY WARNINGS IN THE MANUAL

The following safety warnings are used in this manual:



#### **DANGER!**

Failure to follow the recommended procedures listed in this warning may result in death, serious injury, and equipment damage.



#### **ATTENTION!**

Failure to follow the recommended procedures listed in this warning may result in equipment damage.



#### **NOTE!**

This warning provides important information for the proper understanding and operation of the equipment.

### 1.2 SAFETY WARNINGS IN THE PRODUCT

The following symbols are attached to the product and require special attention:



Indicates a high voltage warning.



Electrostatic discharge sensitive components.  
Do not touch them.



Indicates that a ground (PE) must be connected securely.



Indicates that the cable shield must be grounded.



Indicates a hot surface warning.

### 1.3 PRELIMINARY RECOMMENDATIONS



**DANGER!**

Only trained personnel, with proper qualifications, and familiar with the CFW-11 and associated machinery shall plan and implement the installation, starting, operation, and maintenance of this equipment.

The personnel shall follow all the safety instructions described in this manual and/or defined by the local regulations.

Failure to comply with the safety instructions may result in death, serious injury, and equipment damage.



**NOTE!**

For the purpose of this manual, qualified personnel are those trained and able to:

1. Install, ground, power-up, and operate the CFW-11 according to this manual and to the current legal safety procedures;
2. Use the protection equipment according to the established regulations;
3. Provide first aid.



**DANGER!**

Always disconnect the main power supply before touching any electrical device associated with the inverter.

Several components may remain charged with high voltage and/or in movement (fans), even after the AC power supply has been disconnected or turned off.

Wait at least 10 minutes to guarantee the fully discharge of capacitors.

Always connect the equipment frame to the ground protection (PE).



**ATTENTION!**

The electronic boards contain components sensitive to electrostatic discharges. Do not touch the components and terminals directly. If needed, touch first the grounded metal frame or wear an adequate ground strap.

**Do not perform a withstand voltage test on any part of the inverter!  
If needed, please, consult WEG.**



**NOTE!**

Frequency inverters may cause interference in other electronic devices. Follow the recommendations listed in Chapter 3 – Installation and Connection, to minimize these effects.



**NOTE!**

Fully read this manual before installing or operating the inverter.

## GENERAL INSTRUCTIONS

### 2.1 ABOUT THE MANUAL

The purpose of this manual is to provide you with the basic information needed to install, start-up in the V/f control mode (scalar), and troubleshoot the most common problems of the CFW-11 frequency inverter series.



It is also possible to operate the CFW-11 in the following control modes: V V W, Sensorless Vector and Vector with Encoder. For further details on the inverter operation with other control modes, refer to the Software Manual.

For information on other functions, accessories, and communication, please refer to the following manuals:

- ☑ Software Manual, with a detailed description of the parameters and advanced functions of the CFW-11.
- ☑ Incremental Encoder Interface Module Manual.
- ☑ I/O Expansion Module Manual.
- ☑ RS-232/RS-485 Serial Communication Manual.
- ☑ CANopen Slave Communication Manual.
- ☑ Anybus-CC Communication Manual.

These manuals are included on the CD supplied with the inverter or can be downloaded from the WEG website at - [www.weg.net](http://www.weg.net).

### 2.2 TERMS AND DEFINITIONS

**Normal Duty Cycle (ND):** Inverter duty cycle that defines the maximum continuous operation current ( $I_{RAT-ND}$ ) and the overload current (110 % for 1 minute). The ND cycle is selected by setting P0298 (Application) = 0 (Normal Duty (ND)). This duty cycle shall be used for the operation of motors that are not subjected to high torque loads (with respect to the motor rated torque) during its operation, starting, acceleration, or deceleration.

$I_{RAT-ND}$ : Inverter rated current for use with the normal duty (ND) cycle.  
Overload:  $1.1 \times I_{RAT-ND} / 1$  minute.

**Heavy Duty Cycle (HD):** Inverter duty cycle that defines the maximum continuous operation current ( $I_{RAT-HD}$ ) and the overload current (150 % for 1 minute). The HD cycle is selected by setting P0298 (Application) = 1 (Heavy Duty (HD)). This duty cycle shall be used for the operation of motors that are subjected to high torque (with respect to the motor rated torque) during its operation, starting, acceleration, or deceleration.

$I_{RAT-HD}$ : Inverter rated current for use with the heavy duty (HD) cycle.  
Overload:  $1.5 \times I_{RAT-HD} / 1$  minute.

**Rectifier:** Input circuit of inverters that transforms the AC input voltage in DC voltage. It is composed of power diodes.

**Pre-charge Circuit:** Charges the DC bus capacitors with limited current, which avoids higher peak currents at the inverter power-up.



**DC Bus:** Inverter intermediate circuit; DC voltage obtained from the rectification of the AC input voltage or from an external power supply; feeds the output inverter bridge with IGBTs.

**Power modules U, V, and W:** Set of two IGBTs of the inverter output phases U, V, and W.

**IGBT:** Insulated Gate Bipolar Transistor; basic component of the output inverter bridge. The IGBT works as an electronic switch in the saturated (closed switch) and cut-off (open switch) modes.

**Braking IGBT:** Works as a switch to activate the braking resistors. It is controlled by the DC bus voltage level.

**PTC:** Resistor which resistance value in ohms increases proportionally to the temperature increase; used as a temperature sensor in electrical motors.

**NTC:** Resistor which resistance value in ohms decreases proportionally to the temperature increase; used as a temperature sensor in power modules.

**Keypad:** Device that allows controlling the motor, and viewing/editing inverter parameters. It is composed of motor control keys, navigation keys, and a graphic LCD display.

**FLASH memory:** Non-volatile memory that can be electronically written and erased.

**RAM memory:** Random Access Memory (volatile).

**USB:** Universal Serial Bus; is a serial bus standard that allows devices to be connected using the "Plug and Play" concept.



**PE:** Protective Earth.

**RFI Filter:** Radio-Frequency Interference Filter for interference reduction in the Radio-Frequency range.

**PWM:** Pulse Width Modulation; pulsed voltage that feeds the motor.

**Switching frequency:** Frequency of the IGBTs switching in the inverter bridge, normally expressed in kHz.

**General enable:** When activated, this function accelerates the motor via acceleration ramp set in the inverter. When deactivated, this function immediately blocks the PWM pulses. The general enable function may be controlled through a digital input set to this function or via serial communication.

**Start/Stop:** When enabled in the inverter (start), this function accelerates the motor via acceleration ramp up to the speed reference. When disabled (stop), this function decelerates the motor via deceleration ramp up to the complete motor stop; at this point, the PWM pulses are blocked. The start/stop function may be controlled through a digital input set for this function or via serial communication. The operator keys  and  of the keypad work in a similar way:

 = Start,  = Stop.

**Heatsink:** Metal device designed to dissipate the heat generated by the power semiconductors.

**Amp, A:** Ampères.

**°C:** celsius degree.

**AC:** Alternated Current.

**DC:** Direct Current.

**CFM:** Cubic Feet per Minute; unit of flow.

**hp:** Horse Power = 746 Watts (unit of power, used to indicate the mechanical power of electrical motors).

**Hz:** hertz.

**l/s:** liters per second.

**kg:** kilogram = 1000 grams.

**kHz:** kilohertz = 1000 Hertz.

**mA:** milliampère = 0.001 Ampère.

**min:** minute.

**ms:** millisecond = 0.001 seconds.

**Nm:** newton meter; unit of torque.

**rms:** "Root mean square"; effective value.

**rpm:** revolutions per minute; unit of speed.

**s:** second.

**V:** volts.

**Ω:** ohms.

### 2.3 ABOUT THE CFW-11

The CFW-11 frequency inverter is a high performance product designed for speed and torque control of three-phase induction motors. The main characteristic of this product is the "Vectrue" technology, which has the following advantages:

- ☑ Scalar control (V/f), VVW, or vector control programmable in the same product;
- ☑ The vector control may be programmed as "sensorless" (which means standard motors without using encoders) or as "vector control" with the use of an encoder;
- ☑ The "sensorless" control allows high torque and fast response, even in very low speeds or at the starting;
- ☑ The "vector with encoder" control allows high speed precision for the whole speed range (even with a standstill motor);
- ☑ "Optimal Braking" function for the vector control: allows the controlled braking of the motor, eliminating the additional braking resistors in some applications;
- ☑ "Self-Tuning" feature for vector control. It allows the automatic adjustment of the regulators and control parameters from the identification (also automatic) of the motor parameters and load.

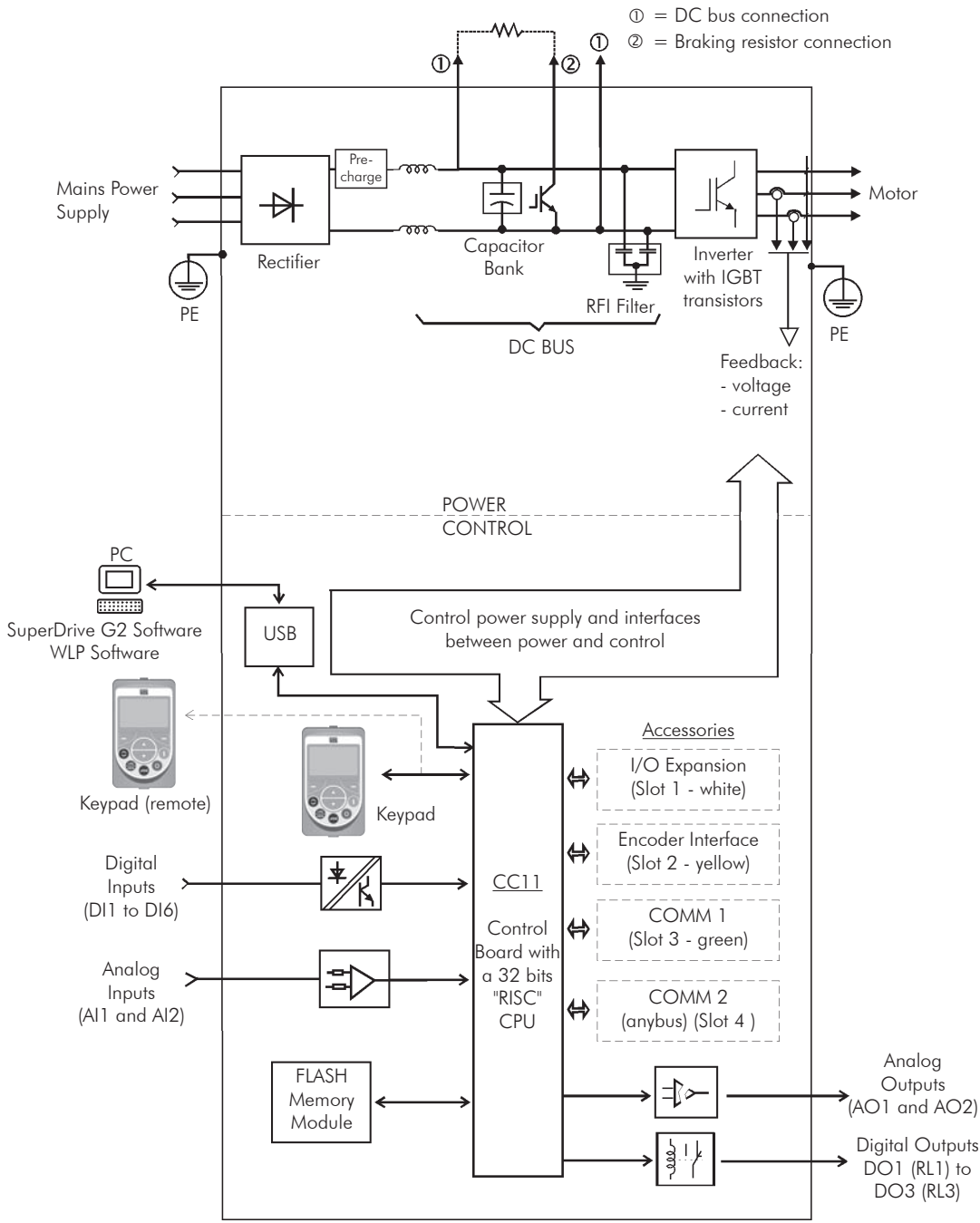
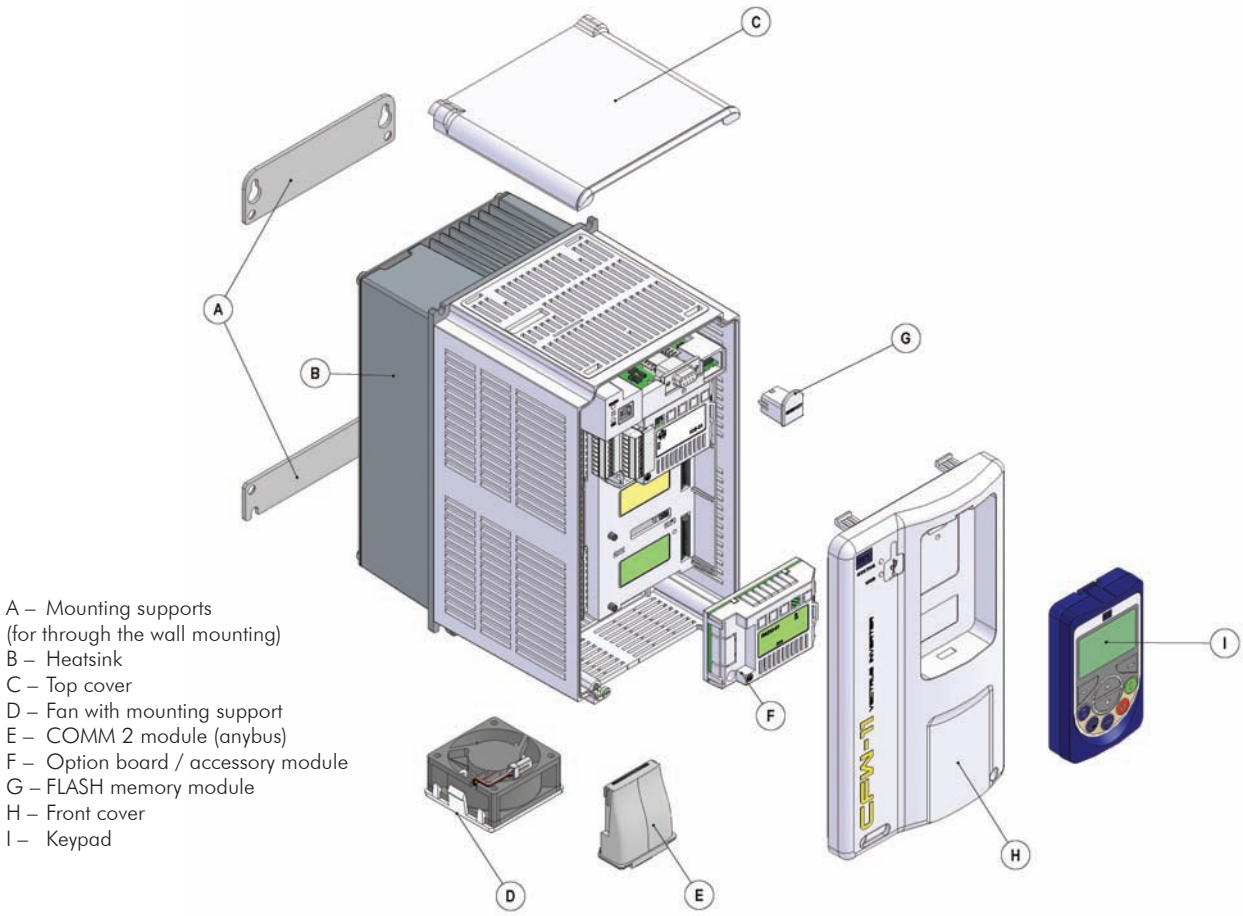
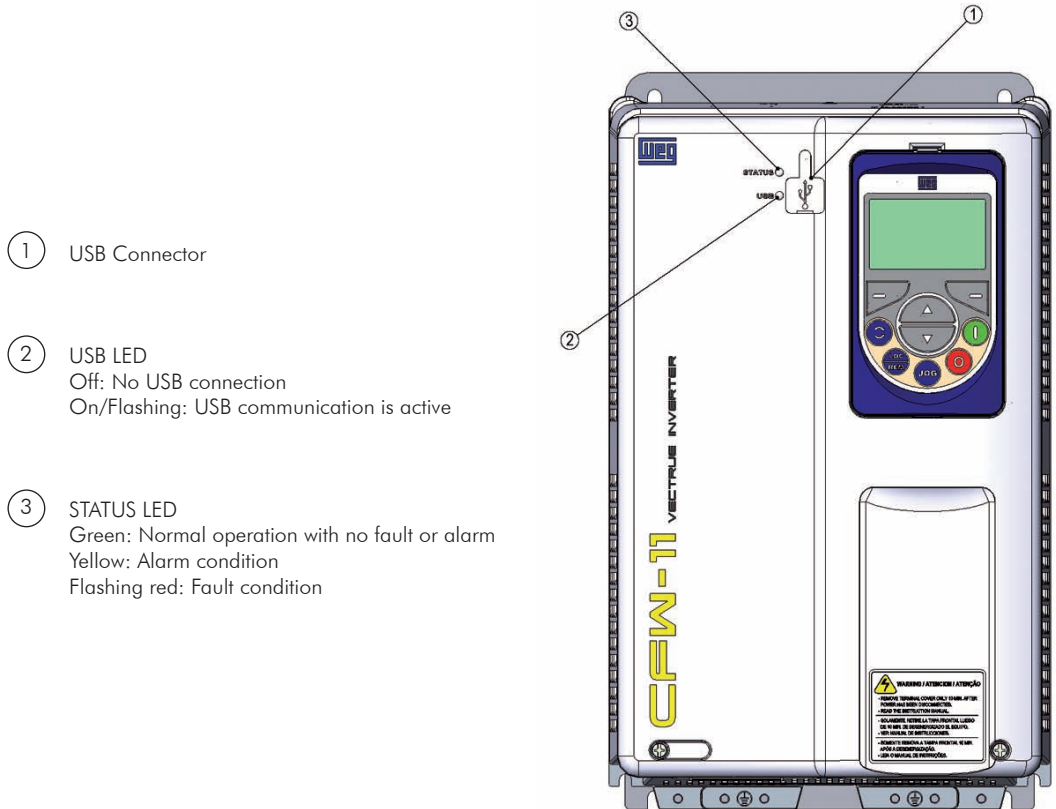

Figure 2.1 - Block diagram for the CFW-11



- A – Mounting supports (for through the wall mounting)
- B – Heatsink
- C – Top cover
- D – Fan with mounting support
- E – COMM 2 module (anybus)
- F – Option board / accessory module
- G – FLASH memory module
- H – Front cover
- I – Keypad

Figure 2.2 - Main components of the CFW-11



- ① USB Connector
- ② USB LED  
Off: No USB connection  
On/Flashing: USB communication is active
- ③ STATUS LED  
Green: Normal operation with no fault or alarm  
Yellow: Alarm condition  
Flashing red: Fault condition

Figure 2.3 - LEDs and USB connector

### 2.4 IDENTIFICATION LABELS FOR THE CFW-11

There are two nameplates on the CFW-11: one complete nameplate is affixed to the side of the inverter and a simplified one is located under the keypad. The nameplate under the keypad allows the identification of the most important characteristics of the inverter even if they are mounted side-by-side.

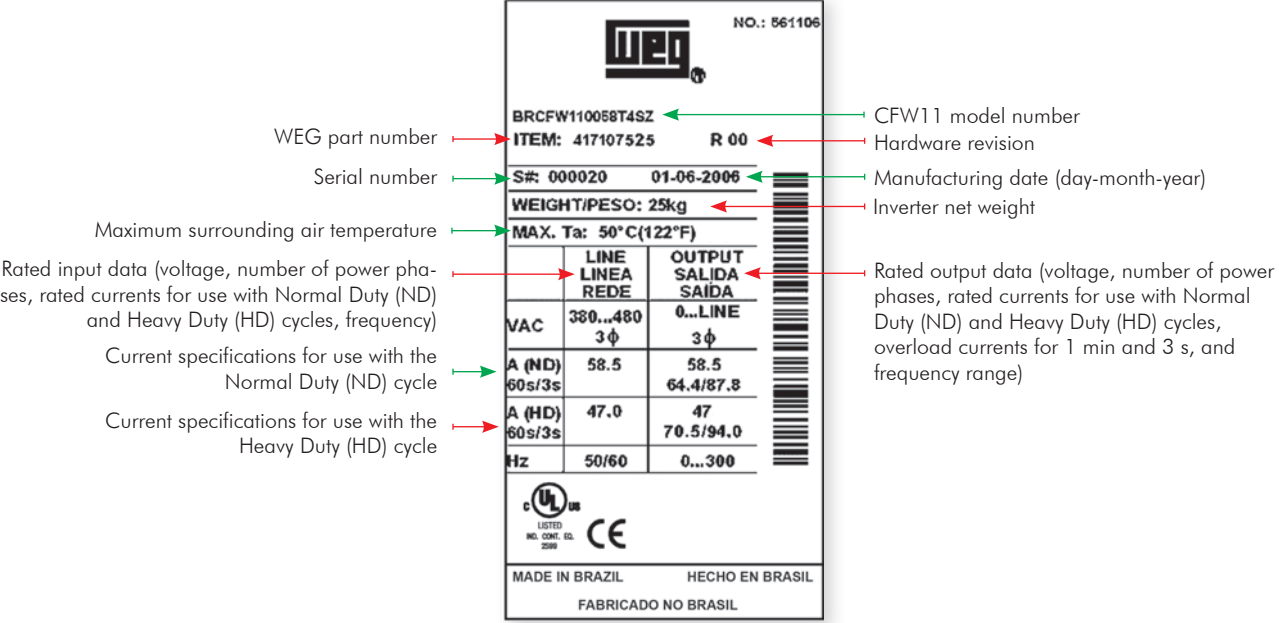

a) Nameplate affixed to the side of the inverter

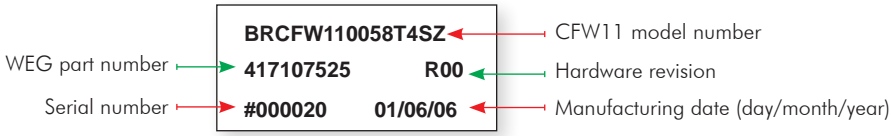

b) Nameplate located under the keypad

Figure 2.4 - Nameplates

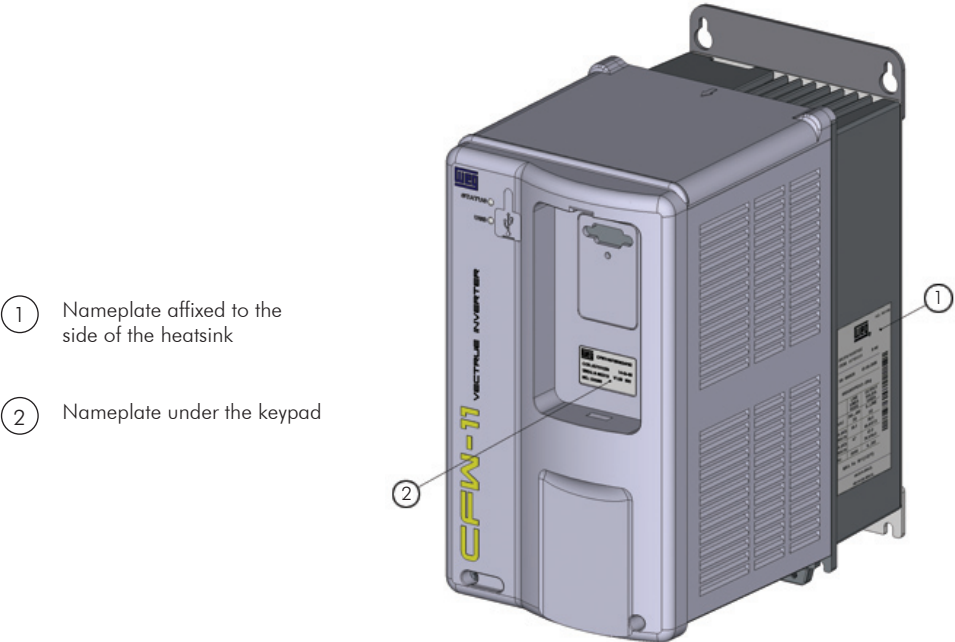

Figure 2.5 - Location of the nameplates

## HOW TO CODIFY THE CFW-11 MODEL (SMART CODE)

INVERTER MODEL		AVAILABLE OPTION KITS (CAN BE INSTALLED IN THE PRODUCT FROM THE FACTORY)													
Refer to chapter 8 for a list of models for the CFW11 series and for a complete inverter's technical specification		Refer to chapter 8 to check option kit availability for each inverter model													
Example	BR	CFW11	0016	T	4	S	--	--	--	--	--	--	--	Z	
Field description	Market identification (defines the manual language and the factory settings)	WEG CFW-11 frequency inverter series	Rated output current for use with the Normal Duty (ND) cycle	Number of power phases	Power supply voltage	Option kit	Enclosure type	Keypad	Braking	RFI filter	Safety stop	24 Vdc external power supply for control	Special hardware	Special software	Character that identifies the code end
Available options	2 characters			S= single-phase power supply T= three-phase power supply B= single or three-phase power supply	2=200...240 V 4=380...480 V	S=standard product O=product with option kit	Blank=standard N1=Nema1 21=IP21	Blank=standard IC=no keypad (blind cover)	Blank=standard <sup>③</sup>	Blank=standard FA=class 3 internal RFI filter	Blank=standard (safety stop function is not available) Y=safety stop according to EN-954-1 category 3	Blank=standard (not available) W=24 Vdc external power supply for control	Blank=standard H1=special hardware #1	Blank=standard S1=special software #1	

① Standard for frames A, B, and C: IP21;

② Standard for frame D: Nema1 / IP20;

③ Standard keypad (HMI-CFW11);

④ Standard: Braking transistor (IGBT) incorporated in all models of frames A, B, C, and D.

## 2.5 RECEIVING AND STORAGE

The CFW-11 is packaged and shipped in a cardboard box for models of frames A, B, and C. The bigger frame models are packaged and shipped in a wood crate.

The same nameplate affixed to the CFW-11 inverter is affixed to the outside of the shipping container.

Follow the instructions below to remove the CFW-11 models above frame C from the package:

- 1- Put the shipping container over a flat and stable area with the assistance of another two people;
- 2- Open the wood crate;
- 3- Remove all the packing material (the cardboard or styrofoam protection) before removing the inverter.

Check the following items once the inverter is delivered:

- Verify that the CFW-11 nameplate corresponds to the model number on your purchase order;
- Inspect the CFW-11 for external damage during transportation.

Report any damage immediately to the carrier that delivered your CFW-11 inverter.

If CFW-11 is to be stored for some time before use, be sure that it is stored in a clean and dry location that conforms to the storage temperature specification (between  $-25\text{ }^{\circ}\text{C}$  and  $60\text{ }^{\circ}\text{C}$  ( $-13\text{ }^{\circ}\text{F}$  and  $140\text{ }^{\circ}\text{F}$ )). Cover the inverter to prevent dust accumulation inside it.



### **ATTENTION!**

Capacitor reforming is required if drives are stored for long periods of time without power. Refer to the procedures in item 6.5 - table 6.3.





## INSTALLATION AND CONNECTION

This chapter provides information on installing and wiring the CFW-11. The instructions and guidelines listed in this manual shall be followed to guarantee personnel and equipment safety, as well as the proper operation of the inverter.

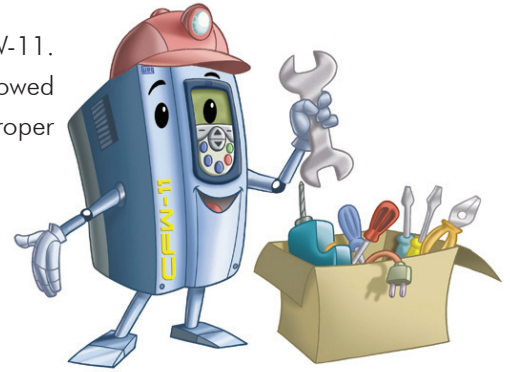

### 3.1 MECHANICAL INSTALLATION

#### 3.1.1 Installation Environment

**Avoid installing the inverter in an area with:**

- ☑ Direct exposure to sunlight, rain, high humidity, or sea-air;
- ☑ Inflammable or corrosive gases or liquids;
- ☑ Excessive vibration;
- ☑ Dust, metallic particles, and oil mist.

**Environment conditions for the operation of the inverter:**

- ☑ Temperature: -10 °C to 50 °C (14 °F to 122 °F) – standard conditions (surrounding the inverter).
- ☑ From 50 °C to 60 °C (122 °F to 140 °F) - 2 % of current derating for each Celsius degree above 50 °C (122 °F).
- ☑ Humidity: from 5 % to 90 % non-condensing.
- ☑ Altitude: up to 1000 m (3,300 ft) - standard conditions (no derating required).
- ☑ From 1000 m to 4000 m (3,300 ft to 13,200 ft) - 1 % of current derating for each 100 m (330 ft) above 1000 m (3,300 ft) altitude.
- ☑ Pollution degree: 2 (according to EN50178 and UL508C) with non-conductive pollution. Condensation shall not originate conduction through the accumulated residues.

#### 3.1.2 Mounting Considerations

Consult the inverter weight at the table 8.1.

Mount the inverter in the upright position on a flat and vertical surface.

External dimensions and fixing holes position according to the figure 3.1. Refer to the section 8.3 for more details.

First mark the mounting points and drill the mouting holes. Then, position the inverter and firmly tighten the screws in all four corners to secure the inverter.

Minimum mounting clearances requirements for proper cooling air circulation are specified in figures 3.2 and 3.3.

Inverters of frames A, B, and C can be arranged side-by-side with no clearance required between them. In this case, the top cover must be removed as shown in figure 3.3 (b).

Do not install heat sensitive components right above the inverter.



#### **ATTENTION!**

When arranging two or more inverters vertically, respect the minimum clearance A + B (figure 3.2) and provide an air deflecting plate so that the heat rising up from the bottom inverter does not affect the top inverter.



**ATTENTION!**

Provide conduit for physical separation of the signal, control, and power conductors (refer to item 3.2 - Electrical Installation).

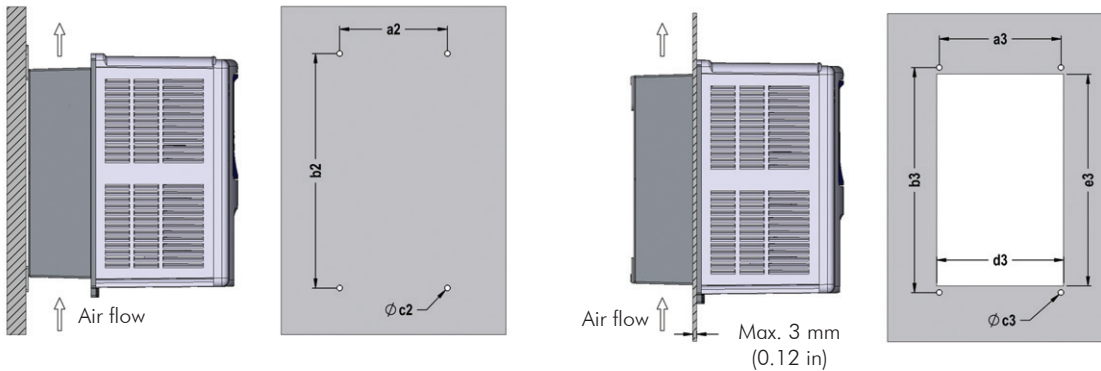
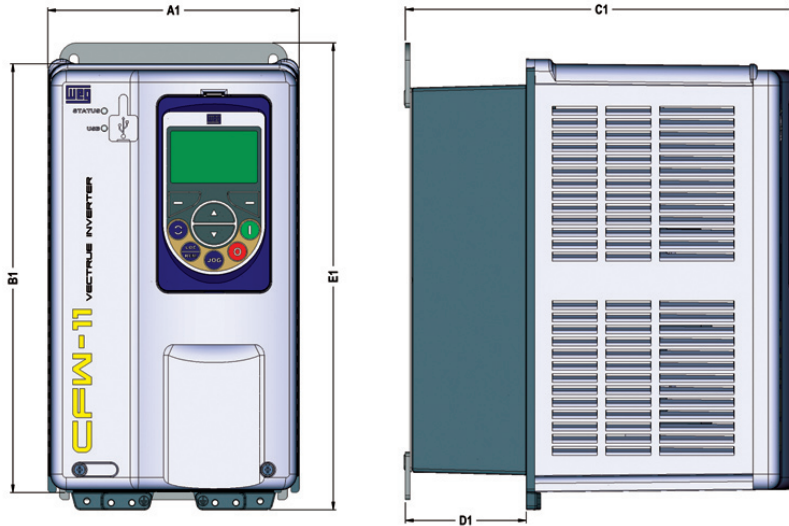

(a) Surface Mounting

(b) Flange Mounting

Model	A1	B1	C1	D1	E1	a2	b2	c2	a3	b3	c3	d3	e3	Torque (*)
	mm (in)	mm (in)	mm (in)	mm (in)	mm (in)	mm (in)	mm (in)	M	mm (in)	mm (in)	M	mm (in)	mm (in)	N.m (lbf.in)
Frame A	145 (5.71)	247 (9.73)	227 (8.94)	70 (2.75)	270 (10.61)	115 (4.53)	250 (9.85)	M5	130 (5.12)	240 (9.45)	M5	135 (5.32)	225 (8.86)	5.0 (44.2)
Frame B	190 (7.46)	293 (11.53)	227 (8.94)	71 (2.78)	316 (12.43)	150 (5.91)	300 (11.82)	M5	175 (6.89)	285 (11.23)	M5	179 (7.05)	271 (10.65)	5.0 (44.2)
Frame C	220 (8.67)	378 (14.88)	293 (11.52)	136 (5.36)	405 (15.95)	150 (5.91)	375 (14.77)	M6	195 (7.68)	365 (14.38)	M6	205 (8.08)	345 (13.59)	8.5 (75.2)
Frame D	300 (11.81)	504 (19.84)	305 (12.00)	135 (5.32)	550 (21.63)	200 (7.88)	525 (20.67)	M8	275 (10.83)	517 (20.36)	M8	285 (11.23)	485 (19.10)	20.0 (177.0)

Tolerances for dimensions d3 and e3: +1.0 mm (+0.039 in)

Tolerances for remaining dimensions: ±1.0 mm (±0.039 in)

(\*) Recommended torque for the inverter mounting (valid for c2 and c3)

Figure 3.1 - Mechanical installation details

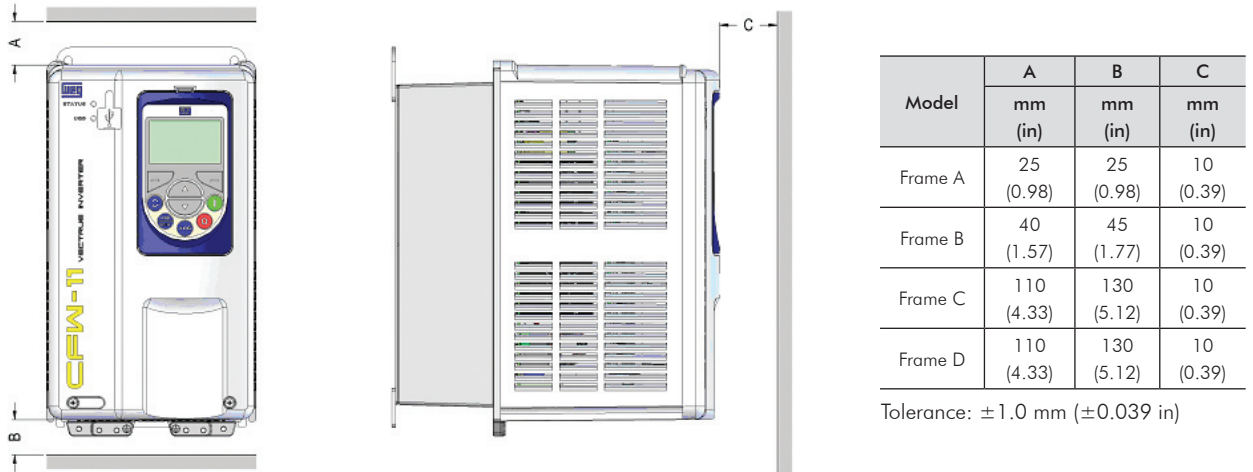
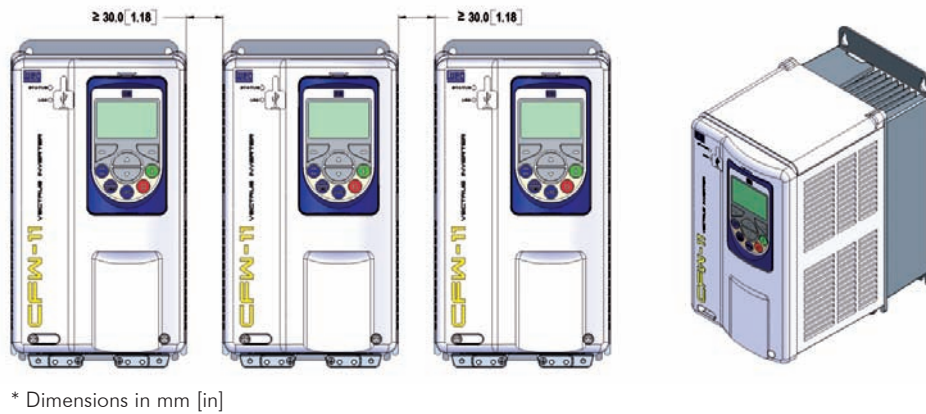
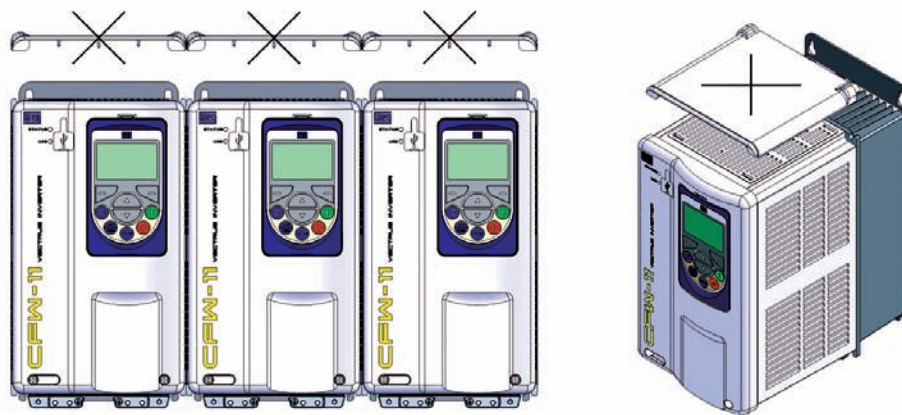

Figure 3.2 - Minimum top, bottom, and front clearance requirements for air circulation



\* Dimensions in mm [in]

(a) Minimum side clearance requirements



(b) Frames A, B, and C: side-by-side mounting - No clearance required between inverters if top cover is removed

Figure 3.3 - Minimum side clearance requirements for inverter ventilation

### 3.1.3 Cabinet Mounting

There are two possibilities for mounting the inverter: through the wall mounting or flange mounting (the heatsink is mounted outside the cabinet and the cooling air of the power module is kept outside the enclosure). The following information shall be considered in these cases:

**Through the wall mounting:**

- ☑ Provide adequate exhaustion so that the internal cabinet temperature is kept within the allowable operating range of the inverter.
- ☑ The power dissipated by the inverter at its rated condition, as specified in table 8.1 "Dissipated power in Watts - Through the wall mounting".
- ☑ The cooling air flow requirements, as shown in table 3.1.
- ☑ The position and diameter of the mounting holes, according to figure 3.1.

**Flange mounting:**

- ☑ The losses specified in table 8.1 "Dissipated power in Watts - Flange mounting" will be dissipated inside the cabinet. The remaining losses (power module) will be dissipated through the vents.
- ☑ The mounting supports shall be removed and repositioned as illustrated in figure 3.4.
- ☑ The portion of the inverter that is located outside the cabinet is rated IP54. Provide an adequate gasket for the cabinet opening to ensure that the enclosure rating is maintained. Example: silicone gasket.
- ☑ Mounting surface opening dimensions and position/diameter of the mounting holes, as shown in figure 3.1.

Table 3.1 - Cooling air flow

Frame	CFM	l/s	m <sup>3</sup> /min
A	18	8	0.5
B	42	20	1.2
C	96	45	2.7
D	132	62	3.7

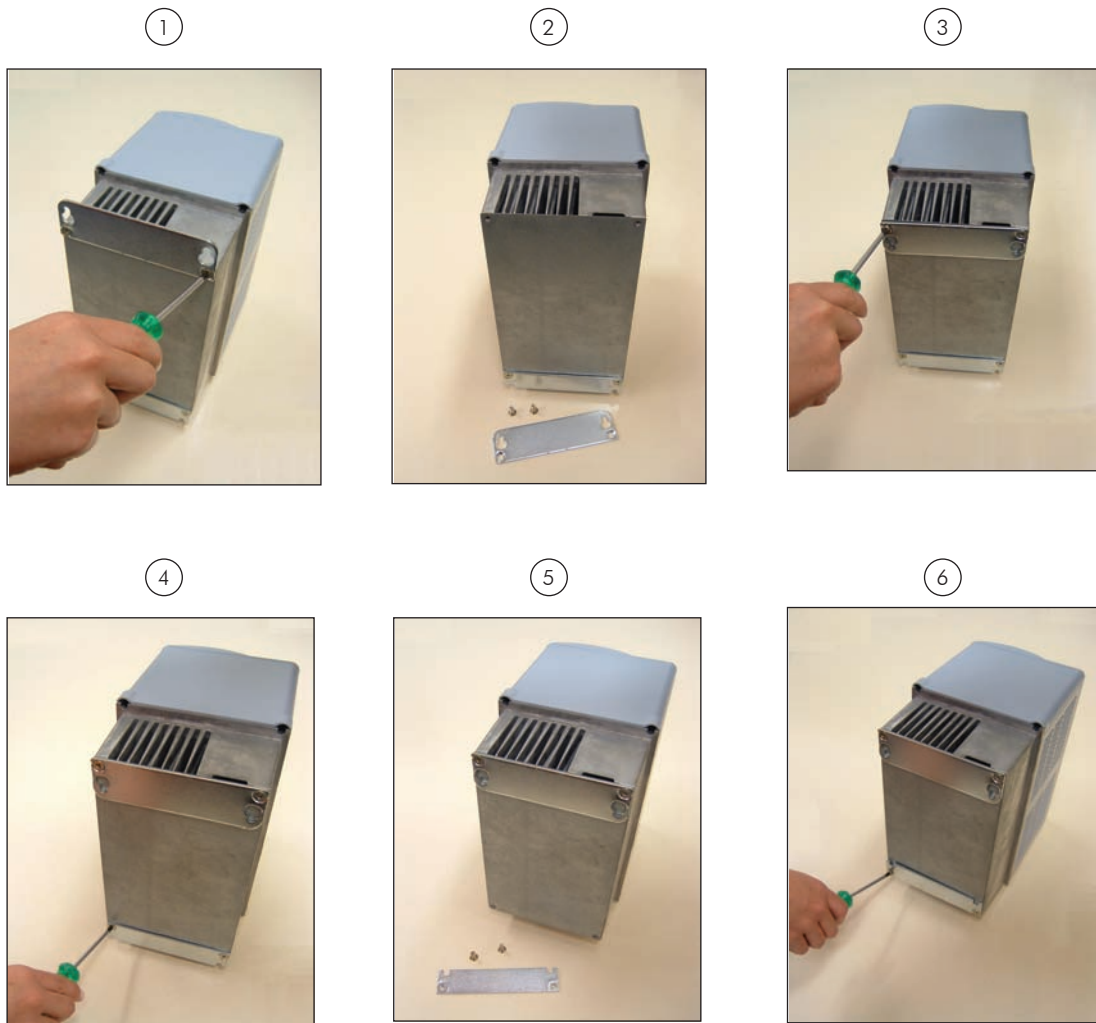

Figure 3.4 - Repositioning the mounting supports

### 3.1.4 Access to the Control and Power Terminal Strips

At frame sizes A, B and C, it is necessary to remove the HMI and the front cover in order to get access to the control and power terminal strips.



Figure 3.5 - Removal of keypad and front cover

## Installation and Connection

At the frame size D inverters, it is necessary to remove the HMI and the control rack cover in order to get access to the control terminal strip (see figure 3.6). In order to get access to the power terminal strip, remove the bottom front cover (see figure 3.7).



Figure 3.6 - HMI and control rack cover removal

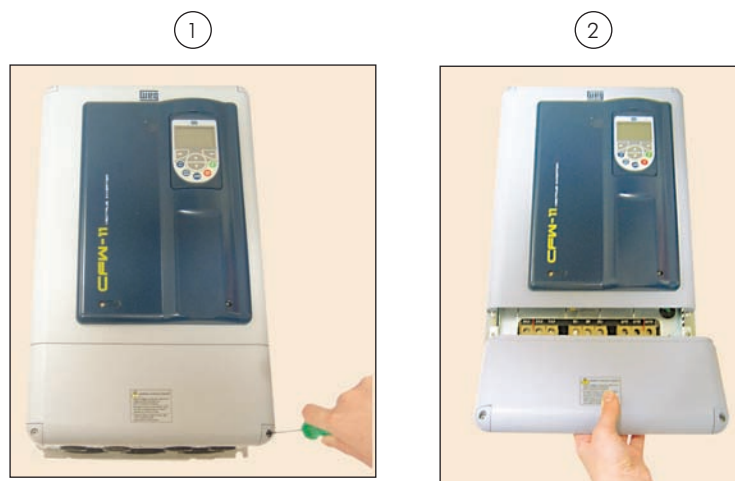

Figure 3.7 - Bottom front cover removal

### 3.2 ELECTRICAL INSTALLATION



**DANGER!**

The following information is merely a guide for proper installation. Comply with applicable local regulations for electrical installations.



**DANGER!**

Make sure the AC power supply is disconnected before starting the installation.

#### 3.2.1 Identification of the Power and Grounding Terminals



**NOTE!**

Models CFW110006B2 and CFW110007B2 may operate with two phases only (single-phase power supply) without rated output current derating. In this case, the single-phase power supply may be connected to two of any input terminals.

Models CFW110006S2OFA, CFW110007S2OFA, and CFW110010S2 only operate with single-phase power supply. In this case, the single-phase power supply shall be connected to terminals R/L1 and S/L2.

R/L1, S/L2, T/L3: AC power supply.

DC-: this is the negative potential terminal in the DC bus circuit.

BR: braking resistor connection.

DC+: this is the positive potential terminal in the DC bus circuit.

U/T1, V/T2, W/T3: motor connection.

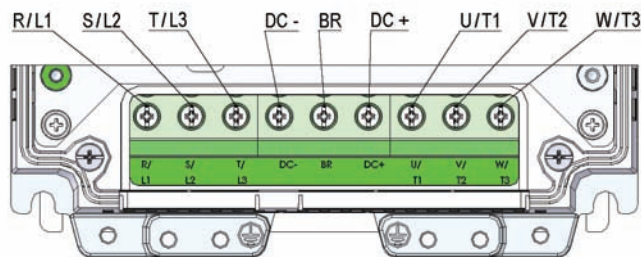

(a) Frames A, B, and C

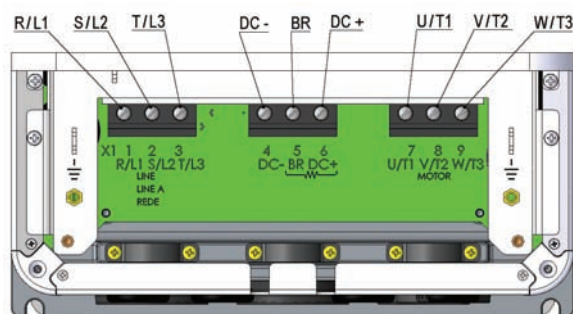

(b) Frame D

Figure 3.8 - Power terminals



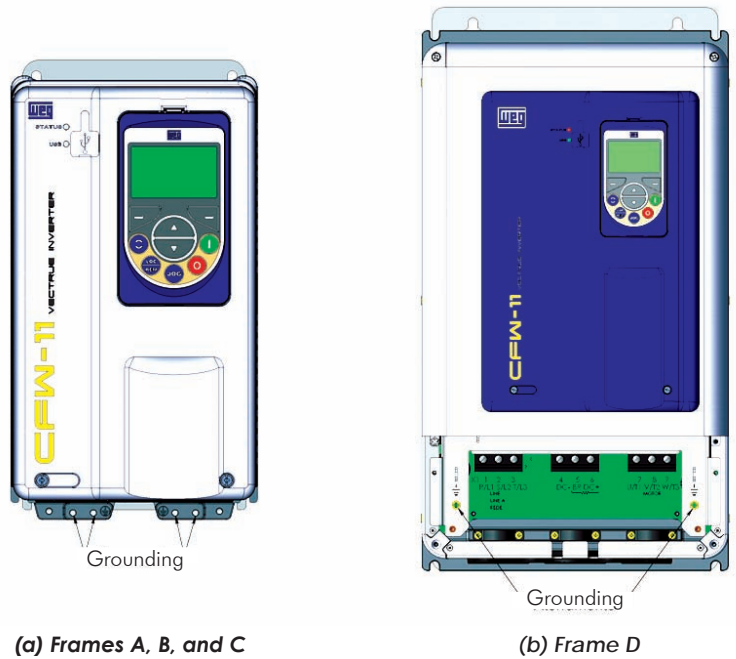

Figure 3.9 - Grounding terminals

3

### 3.2.2 Power / Grounding Wiring and Fuses



**ATTENTION!**

Provide adequate terminals when flexible cables are used for the power and grounding connections.



**ATTENTION!**

Sensitive equipment such as PLCs, temperature controllers, and thermal couples shall be kept at a minimum distance of 0.25 m (0.82 ft) from the frequency inverter and from the cables that connect the inverter to the motor.



**DANGER!**

Improper cable connection:  
The inverter will be damaged in case the input power supply is connected to the output terminals (U/T1, V/T2, or W/T3).  
Check all the connections before powering up the inverter.  
In case of replacing an existing inverter by a CFW-11, check if the installation and wiring is according to the instructions listed in this manual.



**ATTENTION!**

Residual Current Device (RCD):  
- When installing an RCD to guard against electrical shock, only devices with a trip current of 300 mA should be used on the supply side of the inverter.  
- Depending on the installation (motor cable length, cable type, multimotor configuration, etc.), the RCD protection may be activated. Contact the RCD manufacturer for selecting the most appropriate device to be used with inverters.

Table 3.2 - Recommended Wire size/ Fuses - use only copper wire (75 °C (167 °F))

Model	Frame	Power terminal			Wire size			Fuse [A]	Fuse [A] IEC (**)	Fuse I <sup>2</sup> t [A <sup>2</sup> s] @ 25 °C
		Terminals	Screw thread / screw head type	Recommended torque N.m (lbf.in)	mm <sup>2</sup>	AWG	Terminals			
CFW110006B2		R/L1, S/L2, T/L3 U/T1, V/T2, W/T3, DC+, DC- (1)	M4/slotted and Phillips head (comb)	1.8 (15.6)	2.5(1φ) (*)/1.5(3φ)	14	Pin terminal	16	15	420
		⊕ (PE)	M4/Phillips head		1.5		Ring tongue terminal			
CFW110006S2OFA		R/L1/L, S/L2/N U/T1, V/T2, W/T3, DC+, DC- (1)	M4/slotted and Phillips head (comb)	1.8 (15.6)	2.5	14	Pin terminal	16	15	420
		⊕ (PE)	M4/Phillips head		1.5		Ring tongue terminal			
CFW110007B2		R/L1, S/L2, T/L3 U/T1, V/T2, W/T3, DC+, DC- (1)	M4/slotted and Phillips head (comb)	1.8 (15.6)	2.5(1φ) (*)/1.5(3φ)	12(1φ) (*)/14(3φ)	Pin terminal	20(1φ)(*)/ 16(3φ)	20(1φ)/ 15(3φ)	420
		⊕ (PE)	M4/Phillips head		1.5	14	Ring tongue terminal			
CFW110007S2OFA		R/L1/L, S/L2/N U/T1, V/T2, W/T3, DC+, DC- (1)	M4/slotted and Phillips head (comb)	1.8 (15.6)	2.5	12	Pin terminal	16	15	420
		⊕ (PE)	M4/Phillips head		1.5	14	Ring tongue terminal			
CFW110007T2	A	R/L1, S/L2, T/L3, U/T1, V/T2, W/T3, DC+, DC- (1)	M4/slotted and Phillips head (comb)	1.8 (15.6)	1.5	14	Pin terminal	16	15	420
		⊕ (PE)	M4/Phillips head		2.5		Ring tongue terminal			
CFW110010S2		R/L1/L, S/L2/N U/T1, V/T2, W/T3, DC+, DC- (1)	M4/slotted and Phillips head (comb)	1.8 (15.6)	6	10	Pin terminal	25	25	1000
		⊕ (PE)	M4/Phillips head		2.5	14	Ring tongue terminal			
CFW110010T2		R/L1, S/L2, T/L3, U/T1, V/T2, W/T3, DC+, DC- (1)	M4/slotted and Phillips head (comb)	1.8 (15.6)	2.5	14	Pin terminal	16	15	420
		⊕ (PE)	M4/Phillips head				Ring tongue terminal			
CFW110013T2		R/L1, S/L2, T/L3, U/T1, V/T2, W/T3, DC+, DC- (1)	M4/slotted and Phillips head (comb)	1.8 (15.6)	2.5	12	Pin terminal	16	20	420
		⊕ (PE)	M4/Phillips head				Ring tongue terminal			
CFW110016T2		R/L1, S/L2, T/L3, U/T1, V/T2, W/T3, DC+, DC- (1)	M4/slotted and Phillips head (comb)	1.8 (15.6)	4	12	Pin terminal	25	25	420
		⊕ (PE)	M4/Phillips head				Ring tongue terminal			
CFW110024T2		R/L1, S/L2, T/L3, U/T1, V/T2, W/T3, DC+, DC- (1)	M4/Pozidriv head	1.2 (10.8)	6	10	Pin terminal	25	25	1000
		⊕ (PE)	M4/Phillips head	1.7 (15.0)			Ring tongue terminal			
CFW110028T2	B	R/L1, S/L2, T/L3, U/T1, V/T2, W/T3, DC+, DC- (1)	M4/Pozidriv head	1.2 (10.8)	6	8	Pin terminal	35	35	1000
		⊕ (PE)	M4/Phillips head	1.7 (15.0)			Ring tongue terminal			
CFW110033T2		R/L1, S/L2, T/L3, U/T1, V/T2, W/T3, DC+, DC- (1)	M4/Pozidriv head	1.2 (10.8)	10	8	Pin terminal	50	50	1000
		⊕ (PE)	M4/Phillips head	1.7 (15.0)			Ring tongue terminal			

Note.: 1φ: (\*) Wire size for single-phase power supply.

**Table 3.2 (cont.)** - Recommended Wire size/ Fuses - use only copper wire (75 °C (167 °F))

Model	Frame	Power terminal			Wire size			Fuse [A]	Fuse [A] IEC (**)	Fuse I <sup>2</sup> t [A <sup>2</sup> s] @ 25 °C
		Terminals	Screw thread / screw head type	Recommended torque N.m (lbf.in)	mm <sup>2</sup>	AWG	Terminals			
CFW110045T2		R/L1, S/L2, T/L3, U/T1, V/T2, W/T3, DC+ <sup>(2)</sup> , DC- <sup>(2)</sup>	M5/Pozidriv head	2.7 (24.0)	10	6	Pin terminal	50	50	2750
		⊕ (PE)	M5/Phillips head	3.5 (31.0)			Ring tongue terminal			
CFW110054T2	C	R/L1, S/L2, T/L3, U/T1, V/T2, W/T3, DC+ <sup>(2)</sup> , DC- <sup>(2)</sup>	M5/Pozidriv head	2.7 (24.0)	16	6	Pin terminal	63	70	2750
		⊕ (PE)	M5/Phillips head	3.5 (31.0)			Ring tongue terminal			
CFW110070T2		R/L1, S/L2, T/L3, U/T1, V/T2, W/T3, DC+ <sup>(2)</sup> , DC- <sup>(2)</sup>	M5/Pozidriv head	2.7 (24.0)	25	4	Pin terminal	80	80	2750
		⊕ (PE)	M5/Phillips head	3.5 (31.0)			16			
CFW110086T2	D	R/L1, S/L2, T/L3, U/T1, V/T2, W/T3, DC+, DC-	M6/slotted head	5.0 (44.2)	35	2	Pin terminal	100	100	3150
		⊕ (PE)	M5/Phillips head	3.5 (31.0)			16			
CFW110105T2		R/L1, S/L2, T/L3, U/T1, V/T2, W/T3, DC+, DC-	M6/slotted head	5.0 (44.2)	50	1	Pin terminal	125	125	3150
		⊕ (PE)	M5/Phillips head	3.5 (31.0)			25			
CFW110003T4		R/L1, S/L2, T/L3, U/T1, V/T2, W/T3, DC+, DC- <sup>(1)</sup>	M4/Pozidriv head	1.1 (10.0)	1.5	14	Spade tongue (fork) terminal	16	15	190
		⊕ (PE)	M4/Phillips head	1.7 (15.0)			2.5			
CFW110005T4		R/L1, S/L2, T/L3, U/T1, V/T2, W/T3, DC+, DC- <sup>(1)</sup>	M4/Pozidriv head	1.1 (10.0)	1.5	14	Spade tongue (fork) terminal	16	15	190
		⊕ (PE)	M4/Phillips head	1.7 (15.0)			2.5			
CFW110007T4	A	R/L1, S/L2, T/L3, U/T1, V/T2, W/T3, DC+, DC- <sup>(1)</sup>	M4/Pozidriv head	1.1 (10.0)	1.5	14	Spade tongue (fork) terminal	16	15	190
		⊕ (PE)	M4/Phillips head	1.7 (15.0)			2.5			
CFW110010T4		R/L1, S/L2, T/L3, U/T1, V/T2, W/T3, DC+, DC- <sup>(1)</sup>	M4/Pozidriv head	1.1 (10.0)	2.5	14	Spade tongue (fork) terminal	16	15	495
		⊕ (PE)	M4/Phillips head	1.7 (15.0)			Ring tongue terminal			
CFW110013T4		R/L1, S/L2, T/L3, U/T1, V/T2, W/T3, DC+, DC- <sup>(1)</sup>	M4/Pozidriv head	1.1 (10.0)	2.5	12	Spade tongue (fork) terminal	16	20	495
		⊕ (PE)	M4/Phillips head	1.7 (15.0)			Ring tongue terminal			
CFW110017T4		R/L1, S/L2, T/L3, U/T1, V/T2, W/T3, DC+, DC- <sup>(1)</sup>	M4/Pozidriv head	1.2 (10.0)	4	10	Pin terminal	25	25	495
		⊕ (PE)	M4/Phillips head	1.7 (15.0)			Ring tongue terminal			
CFW110024T4	B	R/L1, S/L2, T/L3, U/T1, V/T2, W/T3, DC+, DC- <sup>(1)</sup>	M4/Pozidriv head	1.2 (10.8)	6	10	Pin terminal	35	35	500
		⊕ (PE)	M4/Phillips head	1.7 (15.0)			Ring tongue terminal			
CFW110031T4		R/L1, S/L2, T/L3, U/T1, V/T2, W/T3, DC+, DC- <sup>(1)</sup>	M4/Pozidriv head	1.2 (10.0)	10	8	Pin terminal	35	35	1250
		⊕ (PE)	M4/Phillips head	1.7 (15.0)			Ring tongue terminal			

**Table 3.2 (cont.)** - Recommended Wire size/ Fuses - use only copper wire (75 °C (167 °F))

Model	Frame	Power terminal			Wire size			Fuse [A]	Fuse [A] IEC (**)	Fuse I <sup>2</sup> t [A <sup>2</sup> s] @ 25 °C
		Terminals	Screw thread / screw head type	Recommended torque N.m (lbf.in)	mm <sup>2</sup>	AWG	Terminals			
CFW110038T4		R/L1, S/L2, T/L3, U/T1, V/T2, W/T3, DC+ <sup>(2)</sup> , DC- <sup>(2)</sup>	M5/Pozidriv head	2.7 (24.0)	10	8	Pin terminal	50	50	1250
		⊕ (PE)	M5/Phillips head	3.5 (31.0)			Ring tongue terminal			
CFW110045T4	C	R/L1, S/L2, T/L3, U/T1, V/T2, W/T3, DC+ <sup>(2)</sup> , DC- <sup>(2)</sup>	M5/Pozidriv head	2.7 (24.0)	10	6	Pin terminal	50	50	2100
		⊕ (PE)	M5/Phillips head	3.5 (31.0)			Ring tongue terminal			
CFW110058T4		R/L1, S/L2, T/L3, U/T1, V/T2, W/T3, DC+ <sup>(2)</sup> , DC- <sup>(2)</sup>	M5/Pozidriv head	2.7 (24.0)	16	4	Pin terminal	63	70	2100
		⊕ (PE)	M5/Phillips head	3.5 (31.0)			Ring tongue terminal			
CFW110070T4		R/L1, S/L2, T/L3, U/T1, V/T2, W/T3, DC+, DC-	M5/slotted head	2.9 (24.0)	25	3	Pin terminal	80	80	2100
		⊕ (PE)	M5/Phillips head	3.5 (31.0)	16	4	Ring tongue terminal			
CFW110088T4	D	R/L1, S/L2, T/L3, U/T1, V/T2, W/T3, DC+, DC-	M5/slotted head	2.9 (24.0)	35	2	Pin terminal	100	100	3150
		⊕ (PE)	M5/Phillips head	3.5 (31.0)	16	4	Ring tongue terminal			

(\*\*) Fuse values according to the IEC European standard.

(1) There is a plastic cover in front of the DC- terminal at the frame sizes A and B inverters. It is necessary to break off that cover in order to get access to this terminal.

(2) There are plastic covers in front of the DC-, DC+ and BR terminals at the frame size C. It is necessary to break off those covers in order to get access to these terminals.



**NOTE!**

The wire gauge values listed in table 3.2 are merely a guide. Installation conditions and the maximum permitted voltage drop shall be considered for the proper wiring sizing.

**Input fuses**

- ☑ Use High Speed Fuses at the input for the protection of the inverter rectifier and wiring. Refer to table 3.2 for selecting the appropriate fuse rating (I<sup>2</sup>t shall be equal to or less than indicated in table 3.2, consider the cold (and not the fusion) current extinction value).
- ☑ Optionally, slow blow fuses can be used at the input. They shall be sized for 1.2 x the rated input current of the inverter. In this case, the installation is protected against short-circuit, but not the inverter input rectifier. This may result in major damage to the inverter in the event of an internal component failure.

3.2.3 Power Connections

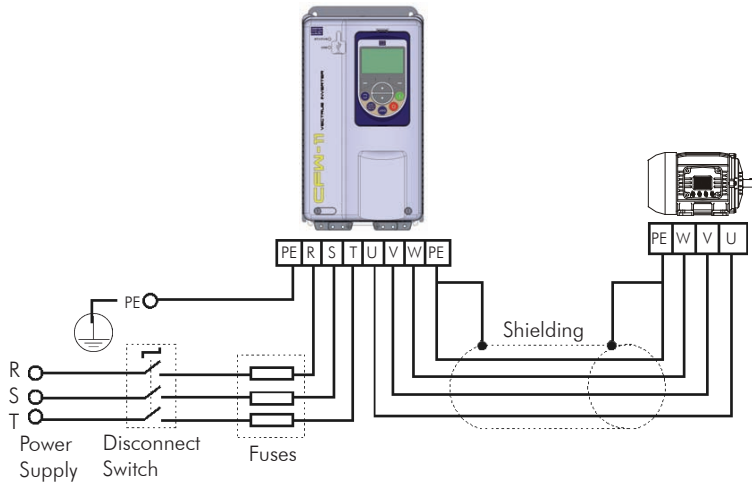

Figure 3.10 - Power and grounding connections

3.2.3.1 Input Connections

3



**DANGER!**

Provide a disconnect device for the input power supply of the inverter. This device shall disconnect the input power supply for the inverter when needed (for instance, during servicing).



**ATTENTION!**

The power supply that feeds the inverter shall have a grounded neutral. In case of IT networks, follow the instructions described in item 3.2.3.1.1.



**NOTE!**

The input power supply voltage shall be compatible with the inverter rated voltage.



**NOTE!**

Power factor correction capacitors are not needed at the inverter input (R, S, T) and shall not be installed at the output of the inverter (U, V, W).

**AC power supply considerations**

- ☑ The CFW-11 inverters are suitable for use on a circuit capable of delivering up to a maximum of 100.000 A<sub>rms</sub> symmetrical (240 V / 480 V).
- ☑ If the CFW-11 inverters are installed in a circuit capable of delivering more than 100.000 A<sub>rms</sub> symmetrical, it is required to install adequate protection devices such as fuses or circuit breakers.

3.2.3.1.1 IT Networks



**ATTENTION!**

Do not use inverters with internal RFI filters in IT networks (neutral is not grounded or grounding provided by a high ohm value resistor) or in grounded delta networks ("delta corner earth"), because these type of networks damage the inverter filter capacitors.

The CFW-11 inverter series, except the models with internal RFI filters – CFW11XXXXXOFA, can be normally used in IT networks. If the available model is equipped with an internal filter, remove the two grounding screws from the filter capacitors as presented in figure 3.11. Remove the keypad and the front cover to have access to these screws in frames A, B, and C. For frame D, the bottom front cover shall be removed as well.

Consider the following items for the use of protection devices on the supply side of the inverter such as residual current devices or isolation monitors:

- The detection of a phase-to-ground short-circuit or an insulation fault shall be processed by the user, i.e., the user shall decide whether to indicate the fault and/or block the inverter operation.
- Contact the RCD manufacturer for selecting the most appropriate device to be used with inverters in order to avoid nuisance tripping due to the high frequency leakage currents that flow through the leakage capacitances of the inverter, cable, and motor system to the ground.

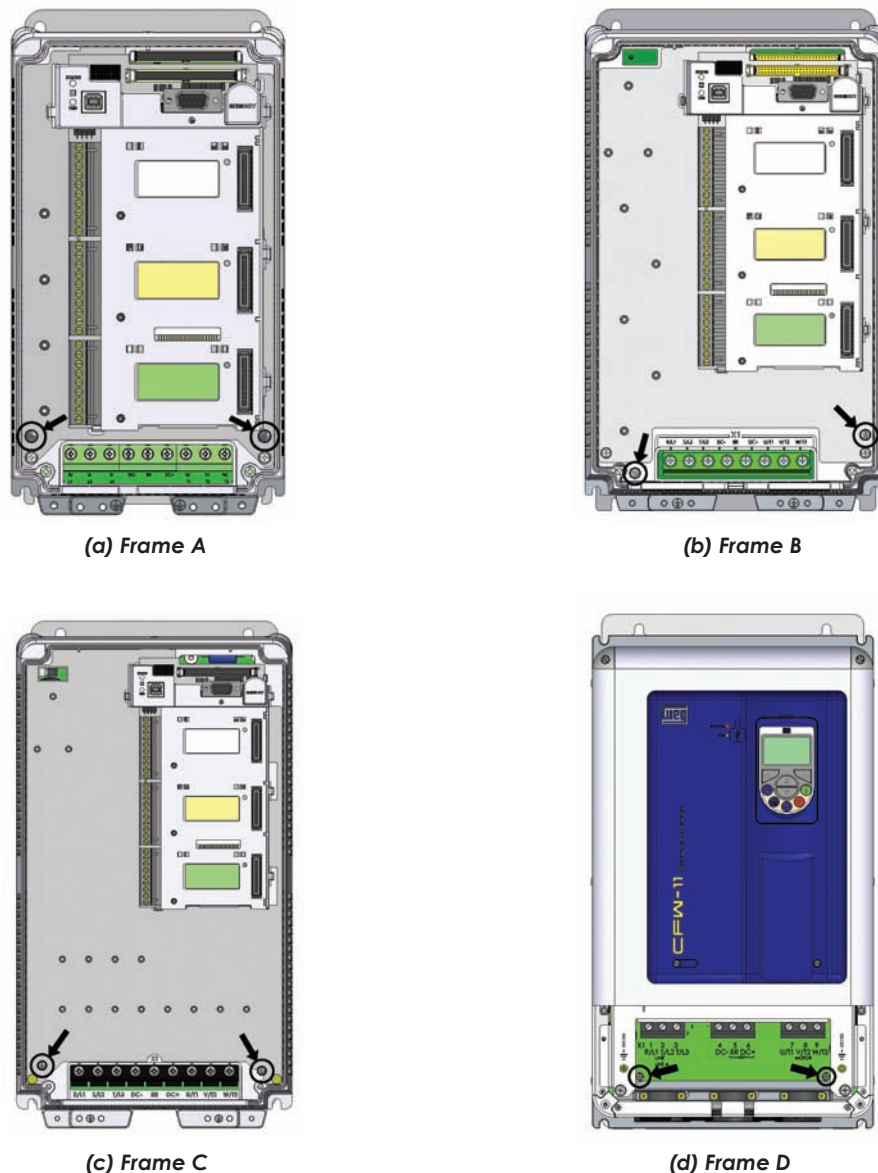

Figure 3.11 - Grounding screws of the filter capacitors - valid for models with internal RFI filters

### 3.2.3.2 Dynamic Braking

The braking torque that can be obtained from the frequency inverter without braking resistors varies from 10 % to 35 % of the motor rated torque.

Braking resistors shall be used to obtain higher braking torques. In this case, the energy regenerated in excess is dissipated in a resistor mounted externally to the inverter.

This type of braking is used in cases where short deceleration times are desired or when high inertia loads are driven.

The "Optimal Braking" feature may be used with the vector control mode, which eliminates in most cases the need of an external braking resistor.



#### **NOTE!**

Set P0151 and P0185 to their maximum values (400 V or 800 V) when using dynamic braking.

3

#### 3.2.3.2.1 Sizing the Braking Resistor

The following application data shall be considered for the adequate sizing of the braking resistor:

- Desired deceleration time;
- Load inertia;
- Braking duty cycle.

In any case, the effective current value and the maximum braking current value presented in table 3.3 shall be respected.

The maximum braking current defines the minimum braking resistor value in ohms.

The DC bus voltage level for the activation of the dynamic braking function is defined by parameter P0153 (dynamic braking level).

The power of the braking resistor is a function of the deceleration time, the load inertia, and the load torque.

For most applications, a braking resistor with the value in ohms indicated in table 3.3 and the power of 20 % of the rated driven motor power. Use WIRE type resistors in a ceramic support with adequate insulation voltage and capable of withstanding high instantaneous power with respect to rated power. For critical applications with very short deceleration times and high inertia loads (ex.: centrifuges) or short duration cycles, consult WEG for the adequate sizing of the braking resistor.

Table 3.3 - Dynamic braking specifications

Inverter model	Maximum braking current ( $I_{max}$ ) [A]	Maximum braking power (peak value) ( $P_{max}$ ) <sup>(2)</sup> [kW]	Effective braking current ( $I_{effective}$ ) <sup>(1)</sup> [A]	Dissipated power (mean value) in the braking resistor ( $P_R$ ) <sup>(2)</sup> [kW]	Recommended resistor [Ω]	Power wire size (terminals DC+ and BR) <sup>(3)</sup> [mm <sup>2</sup> (AWG)]
CFW11 0006 B 2	5.3	2.1	5.20	2.03	75	1.5 (16)
CFW11 0006 S 2 O FA	5.3	2.1	5.20	2.03	75	1.5 (16)
CFW11 0007 B 2	7.1	2.9	6.96	2.71	56	1.5 (16)
CFW11 0007 S 2 O FA	7.1	2.9	6.96	2.71	56	1.5 (16)
CFW11 0007 T 2	5.3	2.1	5.20	2.03	75	1.5 (16)
CFW11 0010 S 2	11.1	4.4	10.83	4.22	36	2.5 (14)
CFW11 0010 T 2	7.1	2.9	6.96	2.71	56	1.5 (16)
CFW11 0013 T 2	11.1	4.4	8.54	2.62	36	2.5 (14)
CFW11 0016 T 2	14.8	5.9	14.44	5.63	27	4 (12)
CFW11 0024 T 2	26.7	10.7	19.15	5.50	15	6 (10)
CFW11 0028 T 2	26.7	10.7	18.21	4.97	15	6 (10)
CFW11 0033 T 2	26.7	10.7	16.71	4.19	15	6 (10)
CFW11 0045 T 2	44.0	17.6	33.29	10.1	9.1	10 (8)
CFW11 0054 T 2	48.8	19.5	32.17	8.49	8.2	10 (8)
CFW11 0070 T 2	48.8	19.5	26.13	5.60	8.2	6 (8)
CFW11 0086 T 2	93.0	37.2	90.67	35.3	4.3	35 (2)
CFW11 0105 T 2	111.1	44.4	90.87	29.7	3.6	35 (2)
CFW11 0003 T 4	3.6	2.9	3.54	2.76	220	1.5 (16)
CFW11 0005 T 4	5.3	4.3	5.20	4.05	150	1.5 (16)
CFW11 0007 T 4	5.3	4.3	5.20	4.05	150	1.5 (16)
CFW11 0010 T 4	8.8	7.0	8.57	6.68	91	2.5 (14)
CFW11 0013 T 4	10.7	8.5	10.40	8.11	75	2.5 (14)
CFW11 0017 T 4	12.9	10.3	12.58	9.81	62	2.5 (12)
CFW11 0024 T 4	17.0	13.6	16.59	12.9	47	4 (10)
CFW11 0031 T 4	26.7	21.3	20.49	12.6	30	6 (10)
CFW11 0038 T 4	36.4	29.1	26.06	14.9	22	6 (8)
CFW11 0045 T 4	47.1	37.6	40.00	27.2	17	10 (8)
CFW11 0058 T 4	53.3	42.7	31.71	15.1	15	10 (8)
CFW11 0070 T 4	66.7	53.3	42.87	22.1	12	10 (6)
CFW11 0088 T 4	87.9	70.3	63.08	36.2	9.1	25 (4)

**Notes:**

(1) The effective braking current presented is just an indicative value, because it depends on the braking duty cycle. The effective braking current can be obtained from the equation below, where  $t_{br}$  is given in minutes and corresponds to the sum of all braking times during the most severe cycle of 5 (five) minutes.

$$I_{effective} = I_{max} \times \sqrt{\frac{t_{br}}{5}}$$

(2) The  $P_{max}$  and  $P_R$  values (maximum and mean power of the braking resistor respectively) presented are valid for the recommended resistors and for the effective braking currents presented in table 3.3. The resistor power shall be changed according to the braking duty cycle.

(3) For specifications on the recommended terminal type (screw and tightening torque) for the connection of the braking resistor (terminals DC+ and BR), refer to the DC+ terminal specification at the table 3.2. There are plastic covers in front of the DC-, DC+ and BR terminals at the frame size C. It is necessary to break off those covers in order to get access to these terminals.



### 3.2.3.2.2 Installation of the Braking Resistor

Install the braking resistor between the power terminals DC+ and BR.

Use twisted cable for the connection. Separate these cables from the signal and control cables. Size the cables according to the application, respecting the maximum and effective currents.

If the braking resistor is installed inside the inverter cabinet, consider its additional dissipated energy when sizing the cabinet ventilation.

Set parameter P0154 with the resistor value in ohms and parameter P0155 with the maximum resistor power in kW.



**DANGER!**

The inverter has an adjustable thermal protection for the braking resistor. The braking resistor and the braking transistor may damage if parameters P0153, P0154, and P0155 are not properly set or if the input voltage surpasses the maximum permitted value.

The thermal protection offered by the inverter, when properly set, allows the protection of the resistor in case of overload; however, this protection is not guaranteed in case of braking circuitry failure. In order to avoid any damage to the resistor or risk of fire, install a thermal relay in series with the resistor and/or a thermostat in contact with the resistor body to disconnect the input power supply of the inverter, as presented in figure 3.12.

3

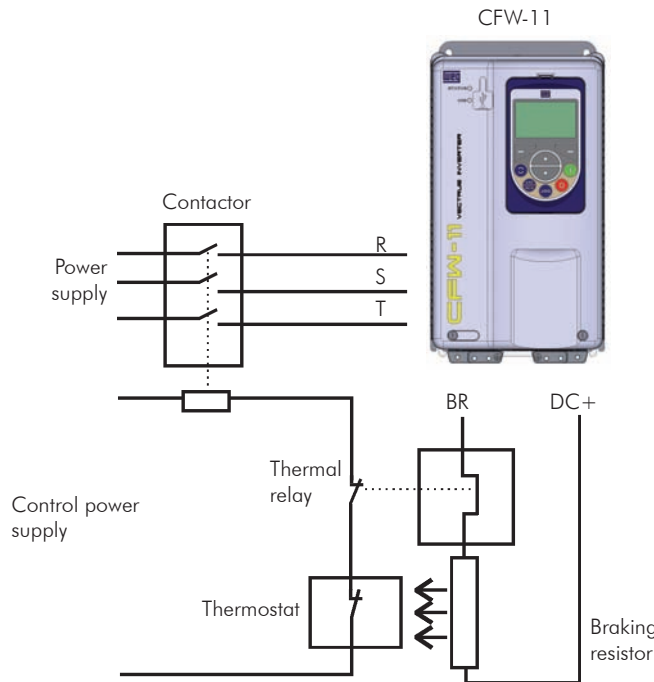

Figure 3.12 - Braking resistor connection



**NOTE!**

DC current flows through the thermal relay bimetal strip during braking.

### 3.2.3.3 Output Connections



**ATTENTION!**

The inverter has an electronic motor overload protection that shall be adjusted according to the driven motor. When several motors are connected to the same inverter, install individual overload relays for each motor.



**ATTENTION!**

If a disconnect switch or a contactor is installed between the inverter and the motor, never operate them with a spinning motor or with voltage at the inverter output.

The characteristics of the cable used for the inverter and motor interconnection, as well as the physical location are extremely important to avoid electromagnetic interference in other equipment and to not affect the life cycle of motor windings and motor bearings controlled by inverters.

**Recommendations for the motor cables:**

Unshielded Cables:

- ☑ Can be used when it is not necessary to meet the European directive of electromagnetic compatibility (89/336/EEC), unless the RFI filters be used as presented in the table 3.9 and section 3.3.1.
- ☑ Keep motor cables away from other cables (signal cables, sensor cables, control cables, etc.), according to table 3.4.
- ☑ The emission of the cables may be reduced by installing them inside a metal conduit, which shall be grounded at both ends.
- ☑ Connect a fourth cable between the motor ground and the inverter ground.

**Note:**

The magnetic field created by the current circulation in these cables may induce current in close metal pieces, heat them, and cause additional electrical losses. Therefore, keep the 3 (three) cables (U, V, W) always together.

Shielded Cables:

- ☑ Are mandatory when the electromagnetic compatibility directive (89/336/EEC) shall be met, as defined by the standard EN 61800-3 “Adjustable Speed Electrical Power Drive Systems”, unless the RFI filters be used as presented in the table 3.9 and section 3.3.1. These cables act mainly by reducing the irradiated emission in the radio-frequency range.
- ☑ Are mandatory when RFI filters, internally or externally mounted, are installed at the inverter input, unless the RFI filters be used as presented in the table 3.9 and section 3.3.1.
- ☑ In reference to the type and details of installation, follow the recommendations of IEC 60034-25 “Guide for Design and Performance of Cage Induction Motors Specifically Designed for Converter Supply” – refer to a summary in figure 3.13. Refer to the standard for further details and eventual modifications related to new revisions.
- ☑ Keep motor cables away from other cables (signal cables, sensor cables, control cables, etc.), according to table 3.4.
- ☑ The grounding system shall be well interconnected among the several installation locations such as the grounding points of the motor and the inverter. Voltage difference or impedance between the several points may cause the circulation of leakage currents among the equipment connected to the ground, resulting in electromagnetic interference problems.

*Table 3.4 - Minimum separation distance between motor cables and all other cables*

Cable length	Minimum separation distance
≤ 30 m (100 ft)	≥ 10 cm (3.94 in)
> 30 m (100 ft)	≥ 25 cm (9.84 in)

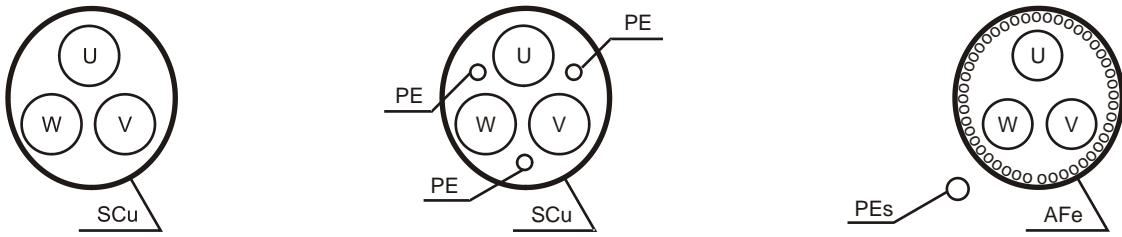

(a) Symmetrical shielded cables: three concentric conductors with or without a ground conductor, symmetrically manufactured, with an external shield of copper or aluminum.

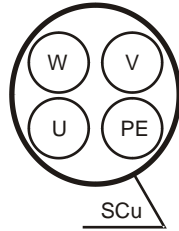

(b) Alternatives for conductors up to 10 mm<sup>2</sup>

**Notes:**

- (1) SCu = copper or aluminum external shielding
- (2) AFe = steel or galvanized iron
- (3) PE = ground conductor
- (4) Cable shielding shall be grounded at both ends (inverter and motor). Use 360° connections for a low impedance to high-frequencies. Refer to figure 3.14.
- (5) For using the shield as a protective ground, it shall have at least 50 % of the power cables conductivity. Otherwise, add an external ground conductor and use the shield as an EMC protection.
- (6) Shielding conductivity at high-frequencies shall be at least 10 % of the power cables conductivity.

Figure 3.13 - Motor connection cables recommended by IEC 60034-25

Connection of the motor cable shield to ground:

The CFW-11 inverter series has some accessories that make the connection of the motor cable shield to the ground easier, resulting in a low impedance connection for high-frequencies.

There is an option accessory for frames A, B, and C named “Kit for power cables shielding – PCSx-01” (refer to item 7.2) that can be adapted in the bottom of the enclosure of these frames. See an example of the cable connection with the accessory PCSx-01 in figure 3.14. The kit for power cables shielding is provided for the inverters with internal RFI filters (CFW11XXXXXOFA).

When the “Conduit Kit” (refer to item 7.2) is used for frames A, B, and C, motor cable shield shall be grounded similarly as in figure 3.14.

For frame D, there is a provision for motor cable shield grounding in the standard inverter enclosure.



Figure 3.14 - Detail of the motor cable shield connection with the accessory PCSx-01 installed

### 3.2.4 Grounding Connections



**DANGER!**

Do not share the grounding wiring with other equipment that operate with high currents (ex.: high power motors, soldering machines, etc.). When installing several inverters, follow the procedures presented in figure 3.15 for the grounding connection.



**ATTENTION!**

The neutral conductor of the network shall be solidly grounded; however, this conductor shall not be used to ground the inverter.



**DANGER!**

The inverter shall be connected to a Protective Ground (PE).

Observe the following:

- Minimum wire gauge for grounding connection is provided in table 3.2. Conform to local regulations and/or electrical codes in case a different wire gauge is required.
- Connect the inverter grounding connections to a ground bus bar, to a single ground point, or to a common grounding point (impedance  $\leq 10 \Omega$ ).
- To comply with IEC 61800-5-1 standard, connect the inverter to the ground by using a single conductor copper cable with a minimum wire gauge of 10 mm<sup>2</sup> or a two-conductor cable with the same wire gauge of the grounding cable specified in table 3.2, since the leakage current is greater than 3.5 mA AC.

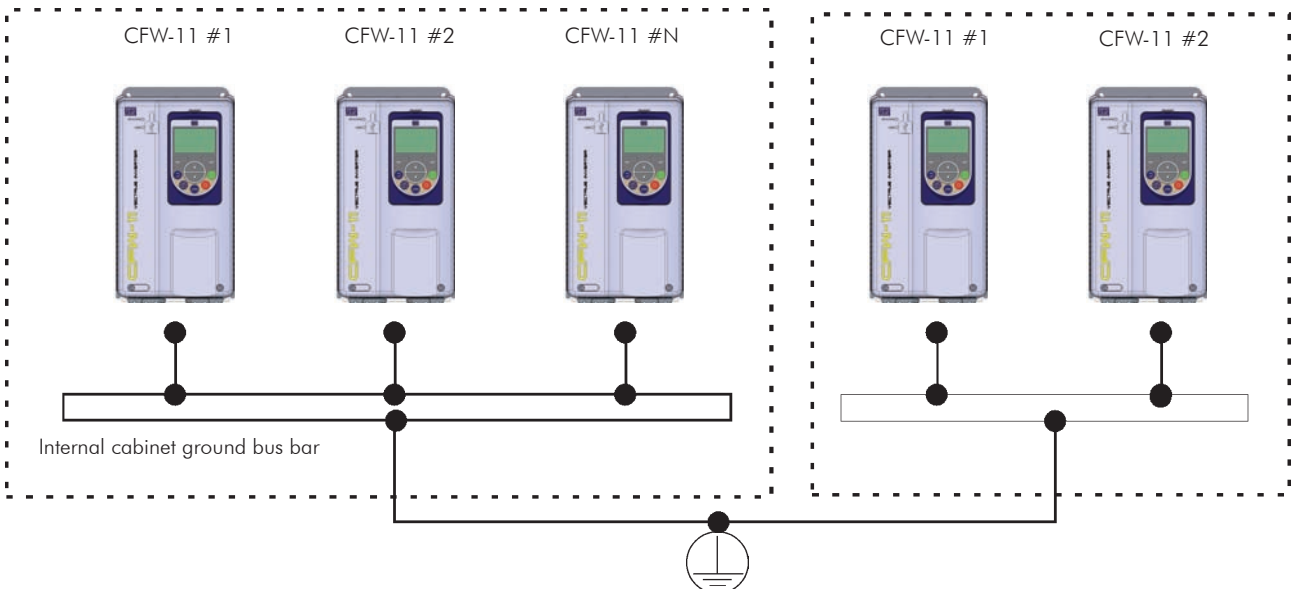

Figure 3.15 - Grounding connections with multiple inverters

### 3.2.5 Control Connections

The control connections (analog inputs/outputs, digital inputs/outputs), shall be performed in connector XC1 of the CC11 control board.

Functions and typical connections are presented in figures 3.16 a) and b).

Connector XC1		Factory Default Function	Specifications
1	+REF	Positive reference for potentiometer	Output voltage: +5.4 V, ±5 %. Maximum output current: 2 mA
2	AI1+	Analog input #1: Speed reference (remote)	Differential Resolution: 12 bits Signal: 0 to 10 V ( $R_{IN}=400\text{ k}\Omega$ ) / 0 to 20 mA / 4 to 20 mA ( $R_{IN}=500\ \Omega$ ) Maximum voltage: ±30 V
3	AI1-		
4	REF-	Negative reference for potentiometer	Output voltage: -4.7 V, ±5 %. Maximum output current: 2 mA
5	AI2+	Analog input #2: No function	Differential Resolution: 11 bits + signal Signal: 0 to ±10 V ( $R_{IN}=400\text{ k}\Omega$ ) / 0 to 20 mA / 4 to 20 mA ( $R_{IN}=500\ \Omega$ ) Maximum voltage: ±30 V
6	AI2-		
7	AO1	Analog output #1: Speed	Galvanic Isolation Resolution: 11 bits Signal: 0 to 10 V ( $R_L \geq 10\text{ k}\Omega$ ) / 0 to 20 mA / 4 to 20 mA ( $R_L \leq 500\ \Omega$ ) Protected against short-circuit.
8	AGND (24 V)	Reference (0 V) for the analog outputs	Connected to the ground (frame) through impedance: 940 $\Omega$ resistor in parallel with a 22 nF capacitor.
9	AO2	Analog output #2: Motor current	Galvanic Isolation Resolution: 11 bits Signal: 0 to 10 V ( $R_L \geq 10\text{ k}\Omega$ ) / 0 to 20 mA / 4 to 20 mA ( $R_L \leq 500\ \Omega$ ) Protected against short-circuit.
10	AGND (24 V)	Reference (0 V) for the analog outputs	Connected to the ground (frame) through impedance: 940 $\Omega$ resistor in parallel with a 22 nF capacitor.
11	DGND*	Reference (0 V) for the 24 Vdc power supply	Connected to the ground (frame) through impedance: 940 $\Omega$ resistor in parallel with a 22 nF capacitor.
12	COM	Common point of the digital inputs	
13	24 Vdc	24 Vdc power supply	24 Vdc power supply, ±8 %. Capacity: 500 mA. <b>Note:</b> In the models with the 24 Vdc external control power supply (CFW11XXXXXOW) the terminal 13 of XC1 becomes an input, i.e., the user must connect a 24 V power supply for the inverter (refer to the section 7.1.3 for more details). In all the other models this terminal is an output, i.e., the user has a 24 V power supply available there.
14	COM	Common point of the digital inputs	
15	DI1	Digital input #1: Start / Stop	6 isolated digital inputs High level ≥ 18 V Low level ≤ 3 V Maximum input voltage = 30 V Input current: 11mA @ 24 Vdc
16	DI2	Digital input #2: Direction of rotation (remote)	
17	DI3	Digital input #3: No function	
18	DI4	Digital input #4: No function	
19	DI5	Digital input #5: Jog (remote)	
20	DI6	Digital input #6: 2 <sup>nd</sup> ramp	
21	NC1	Digital output #1 DO1 (RL1):	Contact rating: Maximum voltage: 240 Vac Maximum current: 1 A NC - Normally closed contact; C - Common; NO - Normally open contact.
22	C1	No fault	
23	NO1		
24	NC2	Digital output #2 DO2 (RL2):	
25	C2	$N > N_x$ - Speed > P0288	
26	NO2		
27	NC3	Digital output #3 DO3 (RL3):	
28	C3	$N^* > N_x$ - Speed reference > P0288	
29	NO3		

Figure 3.16 a) - Signals at connector XC1 - Digital inputs working as 'Active High'

Connector XC1		Factory Default Function	Specifications
1	+REF	Positive reference for potentiometer	Output voltage: +5.4 V, ±5 %. Maximum output current: 2 mA
2	AI1 +	Analog input #1: Speed reference (remote)	Differential Resolution: 12 bits Signal: 0 to 10 V ( $R_{IN} = 400\text{ k}\Omega$ ) / 0 to 20 mA / 4 to 20 mA ( $R_{IN} = 500\ \Omega$ ) Maximum voltage: ±30 V
3	AI1 -		
4	REF-	Negative reference for potentiometer	Output voltage: -4.7 V, ±5 %. Maximum output current: 2 mA
5	AI2 +	Analog input #2: No function	Differential Resolution: 11 bits + signal Signal: 0 to ±10 V ( $R_{IN} = 400\text{ k}\Omega$ ) / 0 to 20 mA / 4 to 20 mA ( $R_{IN} = 500\ \Omega$ ) Maximum voltage: ±30 V
6	AI2 -		
7	AO1	Analog output #1: Speed	Galvanic Isolation Resolution: 11 bits Signal: 0 to 10 V ( $R_L \geq 10\text{ k}\Omega$ ) / 0 to 20 mA / 4 to 20 mA ( $R_L \leq 500\ \Omega$ ) Protected against short-circuit.
8	AGND (24 V)	Reference (0 V) for the analog outputs	Connected to the ground (frame) through impedance: 940 $\Omega$ resistor in parallel with a 22 nF capacitor.
9	AO2	Analog output #2: Motor current	Galvanic Isolation Resolution: 11 bits Signal: 0 to 10 V ( $R_L \geq 10\text{ k}\Omega$ ) / 0 to 20 mA / 4 to 20 mA ( $R_L \leq 500\ \Omega$ ) Protected against short-circuit.
10	AGND (24 V)	Reference (0 V) for the analog outputs	Connected to the ground (frame) through impedance: 940 $\Omega$ resistor in parallel with a 22 nF capacitor.
11	DGND*	Reference (0 V) for the 24 Vdc power supply	Connected to the ground (frame) through impedance: 940 $\Omega$ resistor in parallel with a 22 nF capacitor.
12	COM	Common point of the digital inputs	
13	24 Vdc	24 Vdc power supply	24 Vdc power supply, ±8 %. Capacity: 500 mA. <b>Note:</b> In the models with the 24 Vdc external control power supply (CFW11XXXXXOW) the terminal 13 of XC1 becomes an input, i.e., the user must connect a 24 V power supply for the inverter (refer to the section 7.1.3 for more details). In all the other models this terminal is an output, i.e., the user has a 24 V power supply available there.
14	COM	Common point of the digital inputs	
15	DI1	Digital input #1: Start / Stop	6 isolated digital inputs High level ≥ 18 V Low level ≤ 3 V Input voltage ≤ 30 V Input current: 11 mA @ 24 Vdc
16	DI2	Digital input #2: Direction of rotation (remote)	
17	DI3	Digital input #3: No function	
18	DI4	Digital input #4: No function	
19	DI5	Digital input #5: Jog (remote)	
20	DI6	Digital input #6: 2 <sup>nd</sup> ramp	
21	NC1	Digital output #1 DO1 (RL1): No fault	Contact rating: Maximum voltage: 240 Vac Maximum current: 1 A NC - Normally closed contact; C - Common; NO - Normally open contact.
22	C1		
23	NO1		
24	NC2	Digital output #2 DO2 (RL2): $N > N_x$ - Speed > P0288	
25	C2		
26	NO2		
27	NC3	Digital output #3 DO3 (RL3): $N^* > N_x$ - Speed reference > P0288	
28	C3		
29	NO3		

Figure 3.16 b) - Signals at connector XC1 - Digital inputs working as 'Active Low'



**NOTE!**

Remove the jumper between XC1:11 and 12 and install it between XC1:12 and 13 to use the digital inputs as 'Active Low'.

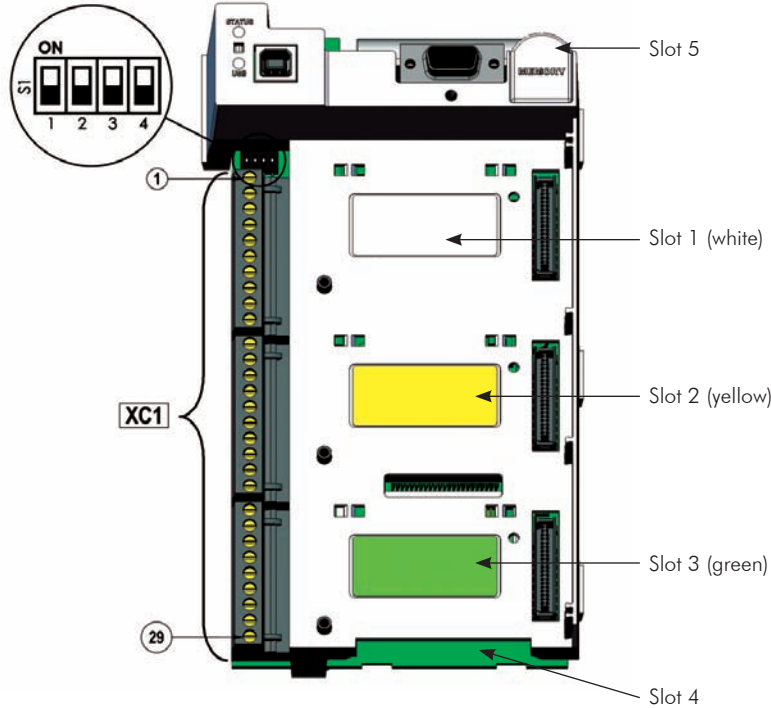

Figure 3.17 - Connector XC1 and DIP-switches for selecting the signal type of the analog inputs and outputs

The analog inputs and outputs are factory set to operate in the range from 0 to 10 V; this setting may be changed by using DIP-switch S1.

Table 3.5 - DIP-switches configuration for the selection of the signal type for the analog inputs and outputs

Signal	Factory Default Function	DIP-switch	Selection	Factory Setting
AI1	Speed Reference (remote)	S1.4	OFF: 0 to 10 V (factory setting) ON: 4 to 20 mA / 0 to 20 mA	OFF
AI2	No Function	S1.3	OFF: 0 to ±10 V (factory setting) ON: 4 to 20 mA / 0 to 20 mA	OFF
AO1	Speed	S1.2	OFF: 4 to 20 mA / 0 to 20 mA ON: 0 to 10 V (factory setting)	ON
AO2	Motor Current	S1.1	OFF: 4 to 20 mA / 0 to 20 mA ON: 0 to 10 V (factory setting)	ON

Parameters related to the analog inputs and outputs (AI1, AI2, AO1, and AO2) shall be programmed according to the DIP-switches settings and desired values.

Follow instructions below for the proper installation of the control wiring:

- 1) Wire gauge: 0.5 mm<sup>2</sup> (20 AWG) to 1.5 mm<sup>2</sup> (14 AWG);
- 2) Maximum tightening torque: 0.50 N.m (4.50 lbf.in);
- 3) Use shielded cables for the connections in XC1 and run the cables separated from the remaining circuits (power, 110 V / 220 Vac control, etc.), as presented in table 3.6. If control wiring must cross other cables (power cables for instance), make it cross perpendicular to the wiring and provide a minimum separation of 5 cm (1.9 in) at the crossing point.

Table 3.6 - Minimum separation distances between wiring

Inverter Rated Output Current	Cable Length	Minimum Separation Distance
≤ 24 A	≤ 100 m (330 ft)	≥ 10 cm (3.94 in)
	> 100 m (330 ft)	≥ 25 cm (9.84 in)
≥ 28 A	≤ 30 m (100 ft)	≥ 10 cm (3.94 in)
	> 30 m (100 ft)	≥ 25 cm (9.84 in)

The adequate connection of the cable shield is shown in figure 3.18. Figure 3.19 shows how to connect the cable shield to the ground.

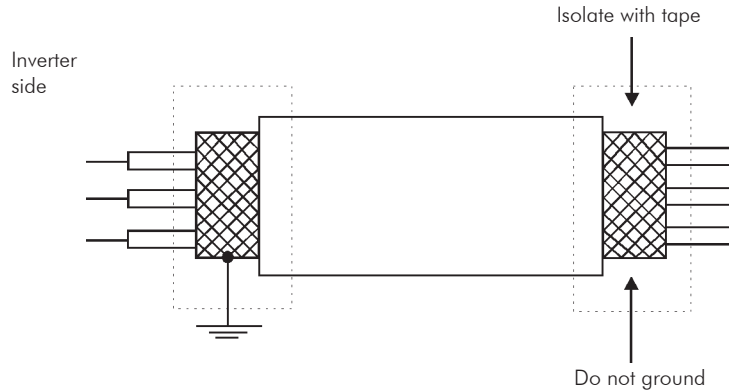

Figure 3.18 - Shield connection

- 4) Relays, contactors, solenoids or coils of electromechanical brakes installed close to the inverter may eventually create interferences in the control circuitry. To eliminate this effect, RC suppressors (with AC power supply) or free-wheel diodes (with DC power supply) shall be connected in parallel to the coils of these devices.

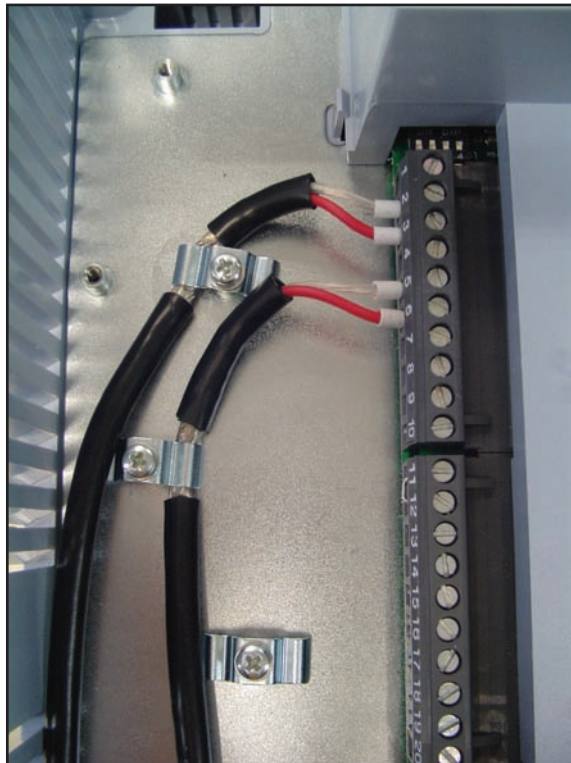

Figure 3.19 - Example of shield connection for the control wiring





### 3.2.6 Typical Control Connections

Control connection #1 - Start/Stop function controlled from the keypad (Local Mode).

With this control connection it is possible to run the inverter in local mode with the factory default settings. This operation mode is recommended for first-time users, since no additional control connections are required.

For the start-up in this operation mode, please follow instructions listed in chapter 5.

Control connection #2 - 2 - Wire Start/Stop function (Remote Mode).

This wiring example is valid only for the default factory settings and if the inverter is set to remote mode. With the factory default settings, the selection of the operation mode (local/remote) is performed through the operator key  (local mode is default). Set P0220=3 to change the default setting of operator key  to remote mode.

3

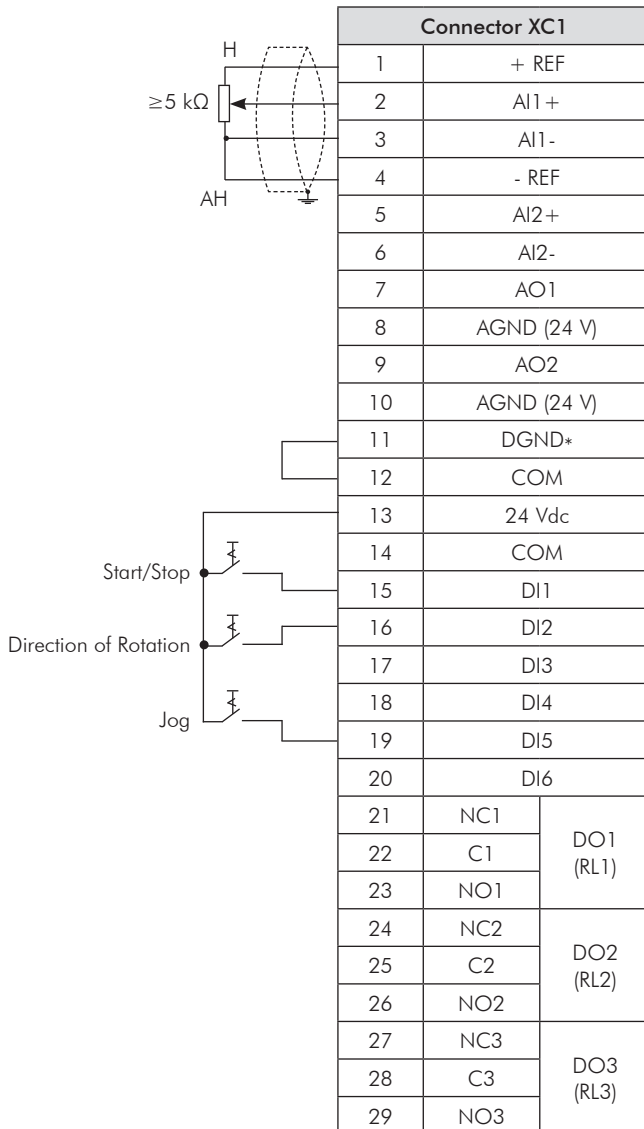

Figure 3.20 - XC1 wiring for Control Connection #2

Control connection #3 - 3 - Wire Start/Stop function.

Enabling the Start/Stop function with 3 Wire control.

Parameters to set:

Set DI3 to START

P0265=6

Set DI4 to STOP

P0266=7

Set P0224=1 (DIx) for 3 wire control in Local mode.

Set P0227=1 (DIx) for 3 wire control in Remote mode.

Set the Direction of Rotation by using digital input #2 (DI2).

Set P0223=4 to Local Mode or P0226=4 to Remote Mode.

S1 and S2 are Start (NO contact) and Stop (NC contact) push-buttons respectively.

The speed reference can be provided through the analog input (as in Control Connection #2), through the keypad (as in Control Connection #1) or through any other available source.

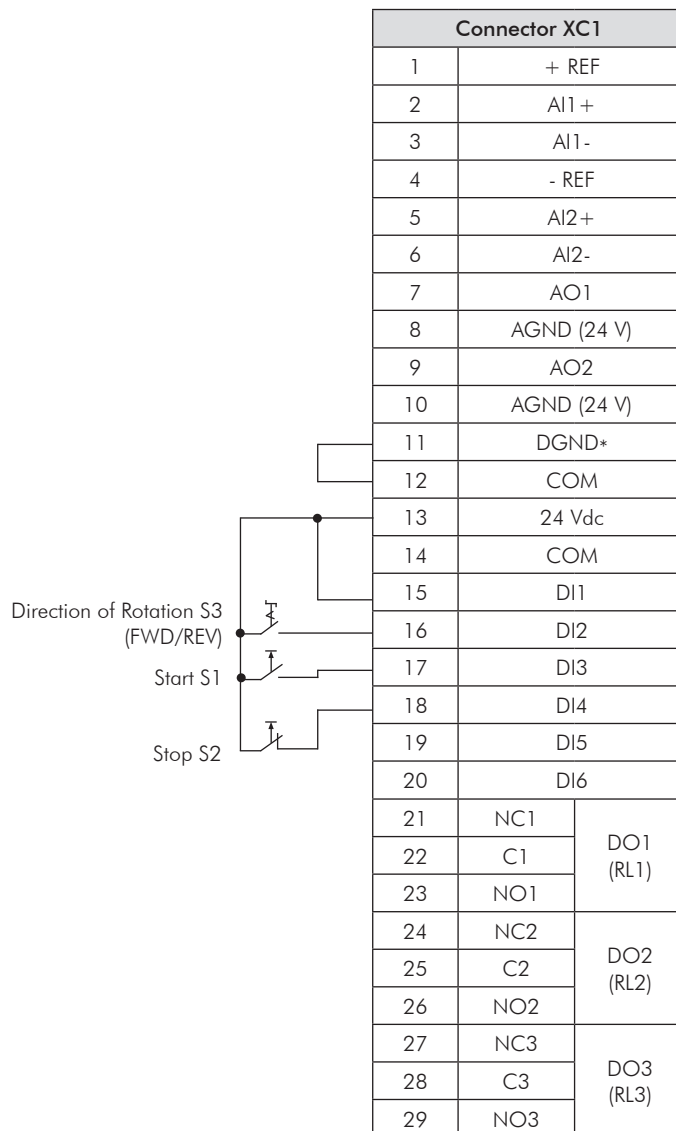

Figure 3.21 - XC1 wiring for Control Connection #3

# Installation and Connection

Control connection #4 - Forward/Reverse.

Enabling the Forward/Reverse function.



Parameters to set:

Set DI3 to FORWARD

P0265=4

Set DI4 to REVERSE

P0266=5

When the Forward/Reverse function is set, it will be active either in Local or Remote mode. At the same time, the operator keys  and  will remain always inactive (even if P0224=0 or P0227=0).

The direction of rotation is determined by the forward and reverse inputs.

Clockwise to forward and counter-clockwise to reverse.

The speed reference can be provided by any source (as in Control Connection #3).

3

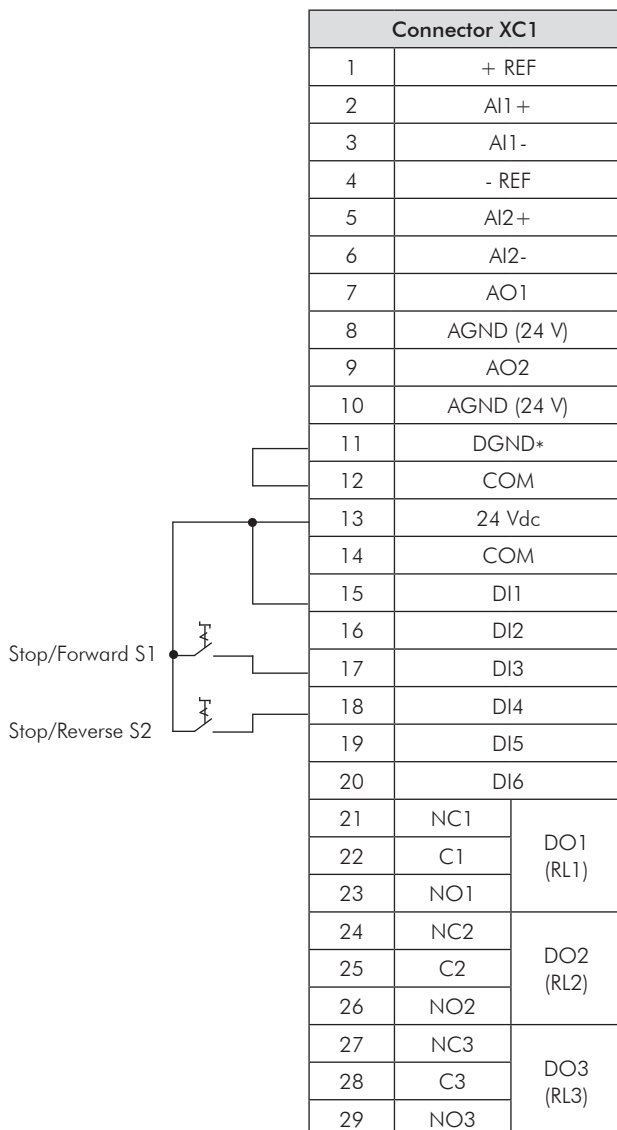

Figure 3.22 - XC1 wiring for Control Connection #4

### 3.3 INSTALLATION ACCORDING TO THE EUROPEAN DIRECTIVE OF ELECTROMAGNETIC COMPATIBILITY

The inverters with the option FA (CFW11XXXXXOFA) are equipped with an internal RFI filter to reduce the electromagnetic interference. These inverters, when properly installed, meet the requirements of the electromagnetic compatibility directive - "EMC Directive 89/336/EEC" – with the complement 93/68/EEC.

The CFW-11 inverter series has been designed only for industrial applications. Therefore, the emission limits of harmonic currents defined by the standards EN 61000-3-2 and EN 61000-3-2/A 14 are not applicable.



#### ATTENTION!

Do not use inverters with internal RFI filters in IT networks (neutral is not grounded or grounding provided by a high ohm value resistor) or in grounded delta networks ("delta corner earth"), because these type of networks damage the filter capacitors of the inverter.

#### 3.3.1 Conformal Installation

For the conformal installation use:

1. Inverters with internal RFI filters option CFW11XXXXXOFA (with grounding screws of the internal RFI filter capacitors).
2. a) Shielded output cables (motor cables) and connect the shield at both ends (motor and inverter) with a low impedance connection for high frequency. Use the PCSx-01 kit supplied with the frame size A, B and C inverters. For the frame sizes D models, use the clamps supplied with the product. Make sure there is a good contact between the cable shield and the clamps. Refer to the figure 3.14 as an example. The required cable separation is presented in table 3.4. For further information, please refer to item 3.2.3. Maximum motor cable length and conducted and radiated emission levels according to the table 3.8. If a lower emission level and/or a longer motor cable were wished, then an external RFI filter must be used at the inverter input. For more information (RFI filter commercial reference, motor cable length and emission levels) refer to the table 3.8.
- b) As a second option only for the V/f and VVW control modes when using a sinusoidal output filter:  
Output cables (motor cables) that are not shielded can be used, provided that RFI filters are installed at the inverter input and output, as presented in the table 3.9. In that table the maximum cable length and the emission levels for each configuration are also presented. Keep the separation from the other cables according to the table 3.4. Refer to the section 3.2.3 for more information.
3. Shielded control cables, keeping them separate from the other cables as described in item 3.2.5.
4. Inverter grounding according to the instructions on item 3.2.4.

### 3.3.2 Standard Definitions

#### IEC/EN 61800-3: "Adjustable Speed Electrical Power Drives Systems"

##### - Environment:

**First Environment:** includes domestic premises. It also includes establishments directly connected without intermediate transformer to a low-voltage power supply network which supplies buildings used for domestic purposes.

Example: houses, apartments, commercial installations, or offices located in residential buildings.

**Second Environment:** includes all establishments other than those directly connected to a low-voltage power supply network which supplies buildings used for domestic purposes.

Example: industrial area, technical area of any building supplied by a dedicated transformer.

##### - Categories:

**Category C1:** inverters with a voltage rating less than 1000 V and intended for use in the First Environment.

**Category C2:** inverters with a voltage rating less than 1000 V, intended for use in the First Environment, not provided with a plug connector or a movable installations, and installed and commissioned by a professional.

**Note:** a professional is a person or organization familiar with the installation and/or commissioning of inverters, including the EMC aspects.

**Category C3:** inverters with a voltage rating less than 1000 V and intended for use in the Second Environment only (not designed for use in the First Environment).

**Category C4:** inverters with a voltage rating equal to or greater than 1000 V, or with a current rating equal to or greater than 400 Amps, or intended for use in complex systems in the Second Environment.

#### EN 55011: "Threshold values and measuring methods for radio interference from industrial, scientific and medical (ISM) high-frequency equipment"

**Class B:** equipment intended for use in the low-voltage power supply network (residential, commercial, and light-industrial environments).

**Class A1:** equipment intended for use in the low-voltage power supply network. Restricted distribution.

**Note:** must be installed and commissioned by a professional when applied in the low-voltage power supply network.

**Class A2:** equipment intended for use in industrial environments.

### 3.3.3 Emission and Immunity Levels

Table 3.7 - Emission and immunity levels

EMC Phenomenon	Basic Standard	Level
Emission:		
Mains Terminal Disturbance Voltage Frequency Range: 150 kHz to 30 MHz)	IEC/EN61800-3	It depends on the inverter model and on the motor cable length. Refer to table 3.8.
Electromagnetic Radiation Disturbance Frequency Range: 30 MHz to 1000 MHz)		
Immunity:		
Electrostatic Discharge (ESD)	IEC 61000-4-2	4 kV for contact discharge and 8 kV for air discharge.
Fast Transient-Burst	IEC 61000-4-4	2 kV/5 kHz (coupling capacitor) power input cables; 1 kV/5 kHz control cables, and remote keypad cables; 2 kV/5 kHz (coupling capacitor) motor output cables.
Conducted Radio-Frequency Common Mode	IEC 61000-4-6	0.15 to 80 MHz; 10 V; 80 % AM (1 kHz). Motor cables, control cables, and remote keypad cables.
Surge Immunity	IEC 61000-4-5	1.2/50 $\mu$ s, 8/20 $\mu$ s; 1 kV line-to-line coupling; 2 kV line-to-ground coupling.
Radio-Frequency Electromagnetic Field	IEC 61000-4-3	80 to 1000 MHz; 10 V/m; 80 % AM (1 kHz).

## Installation and Connection

Table 3.8 - Conducted and radiated emission levels and further information - installations with shield motor cable

Inverter model (with built-in RFI filter)	Without external RFI filter			With external RFI filter				
	Conducted emission - maximum motor cable length		Radiated emission	External RFI filter part number (manufacturer: EPCOS) <sup>(1)</sup>	Conducted emission - maximum motor cable length		Radiated emission - category	
	Category C3	Category C2	Category (no metallic cabinet required)		Category C2	Category C1	Without metallic cabinet	Inside a metallic cabinet <sup>(3)</sup>
CFW11 0006 S 2 O FA	100 m	7 m	C2	B84142-A16-R122	75 m	50 m	C2	C2
				B84142-B16-R	100 m <sup>(2)</sup>	100 m		
CFW11 0007 T 2 O FA	100 m	5 m	C2	B84143-G8-R110	100 m	-	C2	C2
				B84143-A8-R105	50 m <sup>(2)</sup>	50 m		
CFW11 0007 S 2 O FA	100 m	7 m	C2	B84142-A16-R122	75 m	50 m	C2	C2
				B84142-B16-R	100 m <sup>(2)</sup>	100 m		
CFW11 0010 S 2 O FA	100 m	7 m	C2	B84142-A30-R122	75 m	50 m	C2	C2
				B84142-B25-R	100 m <sup>(2)</sup>	100 m		
CFW11 0010 T 2 O FA	100 m	5 m	C2	B84143-G20-R110	100 m	-	C2	C2
				B84143-A16-R105	50 m <sup>(2)</sup>	50 m		
CFW11 0013 T 2 O FA	100 m	5 m	C2	B84143-G20-R110	100 m	-	C2	C2
				B84143-A16-R105	50 m <sup>(2)</sup>	50 m		
CFW11 0016 T 2 O FA	100 m	5 m	C2	B84143-G20-R110	100 m	-	C2	C2
				B84143-A25-R105	50 m <sup>(2)</sup>	50 m		
CFW11 0024 T 2 O FA	100 m	No	C2	B84143-A36-R105	100 m <sup>(2)</sup>	100 m	C2	C2
CFW11 0028 T 2 O FA	100 m	No	C2	B84143-A36-R105	100 m <sup>(2)</sup>	100 m	C2	C2
CFW11 0033 T 2 O FA	100 m	No	C2	B84143-A50-R105	100 m <sup>(2)</sup>	100 m	C2	C2
CFW11 0045 T 2 O FA	100 m	No	C3	B84143-A50-R105	100 m <sup>(2)</sup>	100 m	C3	C2
CFW11 0054 T 2 O FA	100 m	No	C3	B84143-A66-R105	100 m <sup>(2)</sup>	100 m	C3	C2
CFW11 0070 T 2 O FA	100 m	No	C3	B84143-A90-R105	100 m <sup>(2)</sup>	100 m	C3	C2
CFW11 0086 T 2 O FA	100 m	No	C3	B84143-A120-R105	100 m <sup>(2)</sup>	100 m	C3	C2
CFW11 0105 T 2 O FA	100 m	No	C3	B84143-A120-R105	100 m <sup>(2)</sup>	100 m	C3	C2
CFW11 0003 T 4 O FA	100 m	5 m	C2	B84143-G8-R110	100 m	-	C2	C2
				B84143-A8-R105	50 m <sup>(2)</sup>	50 m		
CFW11 0005 T 4 O FA	100 m	5 m	C2	B84143-G8-R110	100 m	-	C2	C2
				B84143-A8-R105	50 m <sup>(2)</sup>	50 m		
CFW11 0007 T 4 O FA	100 m	5 m	C2	B84143-G8-R110	100 m	-	C2	C2
				B84143-A8-R105	50 m <sup>(2)</sup>	50 m		
CFW11 0010 T 4 O FA	100 m	5 m	C2	B84143-G20-R110	100 m	-	C2	C2
				B84143-A16-R105	50 m <sup>(2)</sup>	50 m		
CFW11 0013 T 4 O FA	100 m	5 m	C2	B84143-G20-R110	100 m	-	C2	C2
				B84143-A16-R105	50 m <sup>(2)</sup>	50 m		
CFW11 0017 T 4 O FA	100 m	No	C2	B84143-A25-R105	100 m <sup>(2)</sup>	100 m	C2	C2
CFW11 0024 T 4 O FA	100 m	No	C2	B84143-A36-R105	100 m <sup>(2)</sup>	100 m	C2	C2
CFW11 0031 T 4 O FA	100 m	No	C2	B84143-A36-R105	100 m <sup>(2)</sup>	100 m	C2	C2
CFW11 0038 T 4 O FA	100 m	No	C3	B84143-A50-R105	100 m <sup>(2)</sup>	100 m	C3	C2
CFW11 0045 T 4 O FA	100 m	No	C3	B84143-A50-R105	100 m <sup>(2)</sup>	100 m	C3	C2
CFW11 0058 T 4 O FA	100 m	No	C3	B84143-A66-R105	100 m <sup>(2)</sup>	100 m	C3	C2
CFW11 0070 T 4 O FA	100 m	No	C3	B84143-A90-R105	100 m <sup>(2)</sup>	100 m	C3	C2
CFW11 0088 T 4 O FA	100 m	No	C3	B84143-A120-R105	100 m <sup>(2)</sup>	100 m	C3	C2

### Notes:

(1) The external RFI filters shown in table above were selected considering inverter rated input current specified for ND application (normal duty cycle) and surrounding air temperature of 50 °C (122 °F). In order to optimize, take into account inverter input current and surrounding air temperature in the application to define the rated current of external RFI filter to be used. For further information contact EPCOS.

(2) It's possible to use larger motor cables, but in this case it's required a specific test.

(3) Standard cabinet without additional EMC measures. It's possible to meet category C1 radiated emission levels, adding EMC accessories in the cabinet. In this case it's required to perform specific test to check the emission levels.

Table 3.9 - Required RFI filters for unshielded motor cable installations and further information on conducted and radiated levels

Inverter model (with built-in RFI filter)	External RFI filters part number (manufacturer: EPCOS) <sup>(1)</sup>		Conducted emission - maximum motor cable length	Radiated emission - category	
	Inverter input	Inverter output <sup>(2)</sup>	Category C1	Without metallic cabinet	Inside a metallic cabinet
CFW11 0006 S 2 O FA	B84142-A16-R122	B84143-V11-R127	250 m	C3	C3
CFW11 0007 T 2 O FA	B84143-A8-R105	B84143-V11-R127	250 m	C2	C2
CFW11 0007 S 2 O FA	B84142-A16-R122	B84143-V11-R127	250 m	C3	C3
CFW11 0010 S 2 O FA	B84142-A30-R122	B84143-V16-R127	250 m	C3	C3
CFW11 0010 T 2 O FA	B84143-A16-R105	B84143-V16-R127	250 m	C2	C2
CFW11 0013 T 2 O FA	B84143-A16-R105	B84143-V16-R127	250 m	C2	C2
CFW11 0016 T 2 O FA	B84143-A25-R105	B84143-V33-R127	250 m	C2	C2
CFW11 0024 T 2 O FA	B84143-A36-R105	B84143-V33-R127	250 m	C3	C2
CFW11 0028 T 2 O FA	B84143-A36-R105	B84143-V66-R127	250 m	C3	C2
CFW11 0033 T 2 O FA	B84143-A50-R105	B84143-V66-R127	250 m	C3	C2
CFW11 0045 T 2 O FA	B84143-D50-R127	B84143-V66-R127	250 m	C3	C2
CFW11 0054 T 2 O FA	B84143-D75-R127	B84143-V66-R127	250 m	C3	C2
CFW11 0070 T 2 O FA	B84143-D75-R127	B84143-V95-R127	250 m	C3	C2
CFW11 0086 T 2 O FA	B84143-A120-R105	B84143-V180-R127	250 m	C3	C2
CFW11 0105 T 2 O FA	B84143-A120-R105	B84143-V180-R127	250 m	C3	C2
CFW11 0003 T 4 O FA	B84143-A8-R105	B84143-V11-R127	250 m	C2	C2
CFW11 0005 T 4 O FA	B84143-A8-R105	B84143-V11-R127	250 m	C2	C2
CFW11 0007 T 4 O FA	B84143-A8-R105	B84143-V11-R127	250 m	C2	C2
CFW11 0010 T 4 O FA	B84143-A16-R105	B84143-V16-R127	250 m	C2	C2
CFW11 0013 T 4 O FA	B84143-A16-R105	B84143-V16-R127	250 m	C2	C2
CFW11 0017 T 4 O FA	B84143-A25-R105	B84143-V33-R127	250 m	C3	C2
CFW11 0024 T 4 O FA	B84143-A36-R105	B84143-V33-R127	250 m	C3	C2
CFW11 0031 T 4 O FA	B84143-A36-R105	B84143-V66-R127	250 m	C3	C2
CFW11 0038 T 4 O FA	B84143-D50-R127	B84143-V66-R127	250 m	C3	C2
CFW11 0045 T 4 O FA	B84143-D50-R127	B84143-V66-R127	250 m	C3	C2
CFW11 0058 T 4 O FA	B84143-D75-R127	B84143-V95-R127	250 m	C3	C2
CFW11 0070 T 4 O FA	B84143-A90-R105	B84143-V95-R127	250 m	C3	C2
CFW11 0088 T 4 O FA	B84143-A120-R105	B84143-V180-R127	250 m	C3	C2

**Note:**

(1) The external RFI filters shown in table above were selected considering inverter rated input/output current specified for ND application (normal duty cycle) and surrounding air temperature of 50 °C (122 °F). In order to optimize, take into account inverter input/output current and surrounding air temperature in the application to define the rated current of external RFI filter to be used. For further information contact EPCOS.

(2) The output filter is of the sinusoidal type, i.e., the motor voltage waveform is approximately sinusoidal, not pulsed as in the applications without this filter.





## KEYPAD AND DISPLAY

This chapter describes:

- The operator keys and their functions;
- The indications on the display;
- How parameters are organized.



### 4.1 INTEGRAL KEYPAD - HMI-CFW11

The integral keypad can be used to operate and program (view / edit all parameters) of the CFW-11 inverter. The inverter keypad navigation is similar to the one used in cell phones and the parameters can be accessed in numerical order or through groups (Menu).

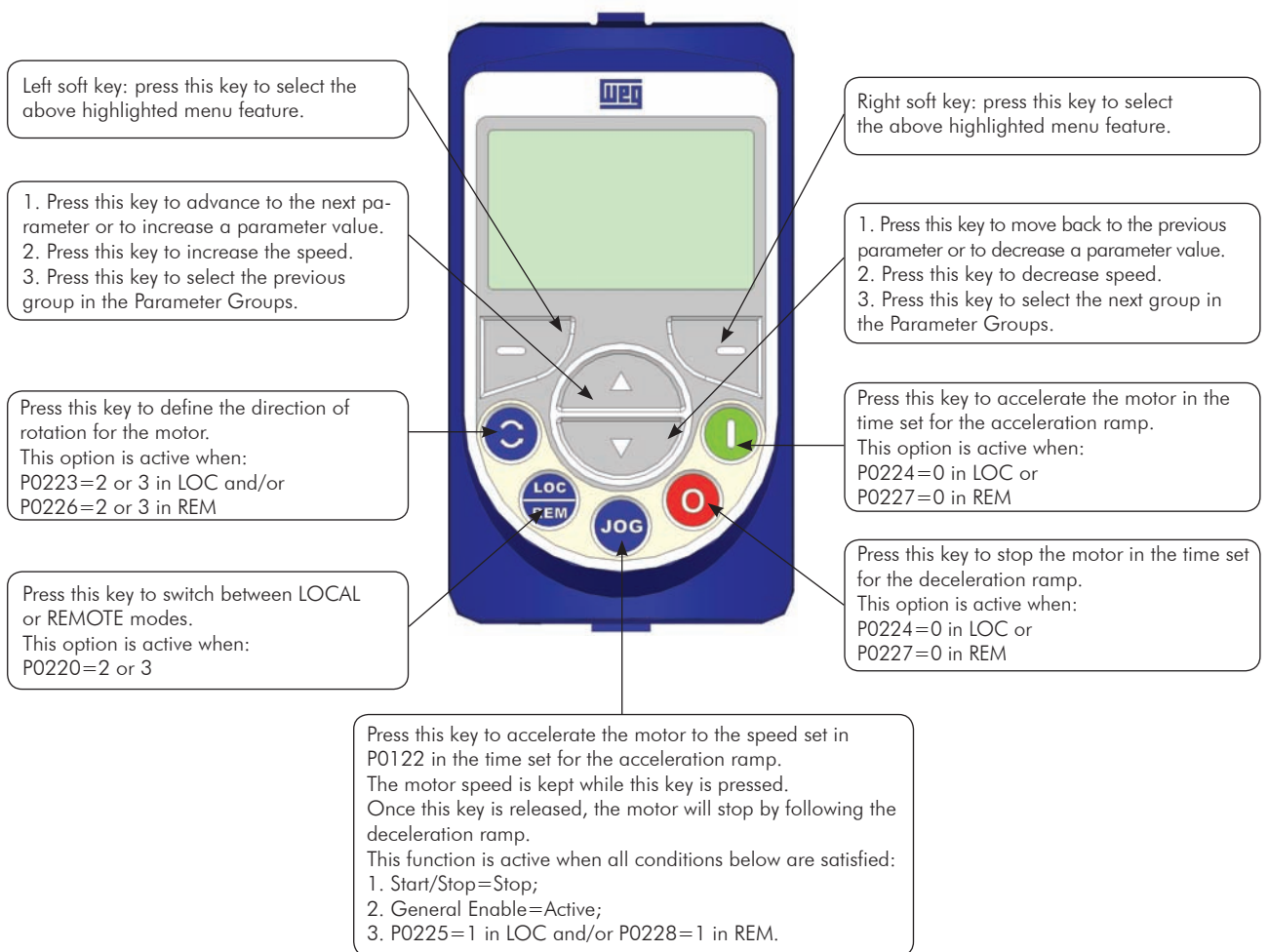

Figure 4.1 - Operator keys

### **Battery:**

The keypad battery is used to keep the clock operating in the event of power interruption.

The expected battery life is up to 10 years. To remove the battery, rotate and pull the cover located at the rear part of the keypad. Whenever needed, replace the battery by another of the same type (CR2032).



### **NOTE!**

The battery is only required for the clock-related functions. If the battery is completely discharge or if it not installed in the keypad, the displayed clock time will be invalid and an alarm condition A181 - Invalid clock time will be indicated whenever the AC power is applied to the inverter.

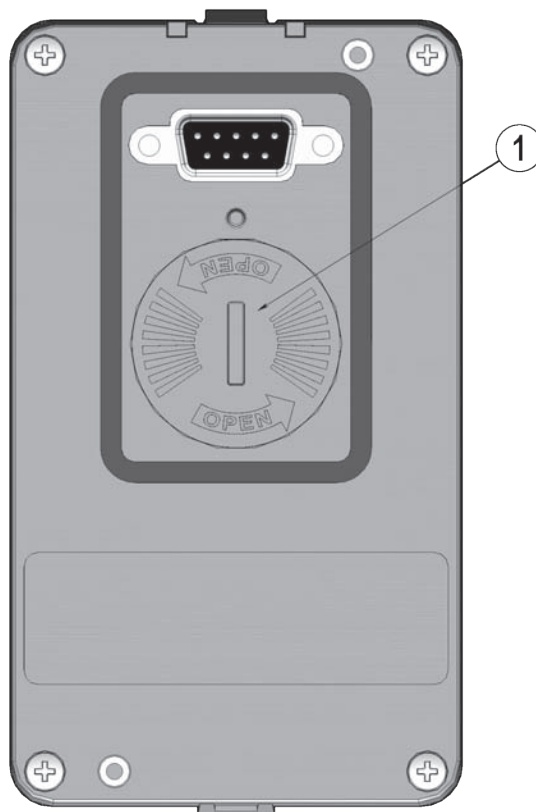

① Cover for battery access

Figure 4.2 - Rear part of the keypad

### **Installation:**

- ☑ The keypad can be installed or removed from the inverter with or without AC power applied to the inverter.
- ☑ The HMI supplied with the product can also be used for remote command of the inverter. In this case, use a cable with male and female D-Sub9 (DB-9) connectors wired pin to pin (mouse extension type) or a market standard Null-Modem cable. It is recommended the use of the M3 x 5.8 standoffs supplied with the product. Recommended torque: 0.5 Nm (4.5 lbf in).

When power is applied to the inverter, the display automatically enters the monitoring mode. Figure 4.3 (a) presents the monitoring screen displayed for the factory default settings. By properly setting specific inverter parameters, other variables can be displayed in the monitoring mode or the value of a parameter can be displayed using bar graphs or with larger characters as presented in figures 4.3 (b) and (c).

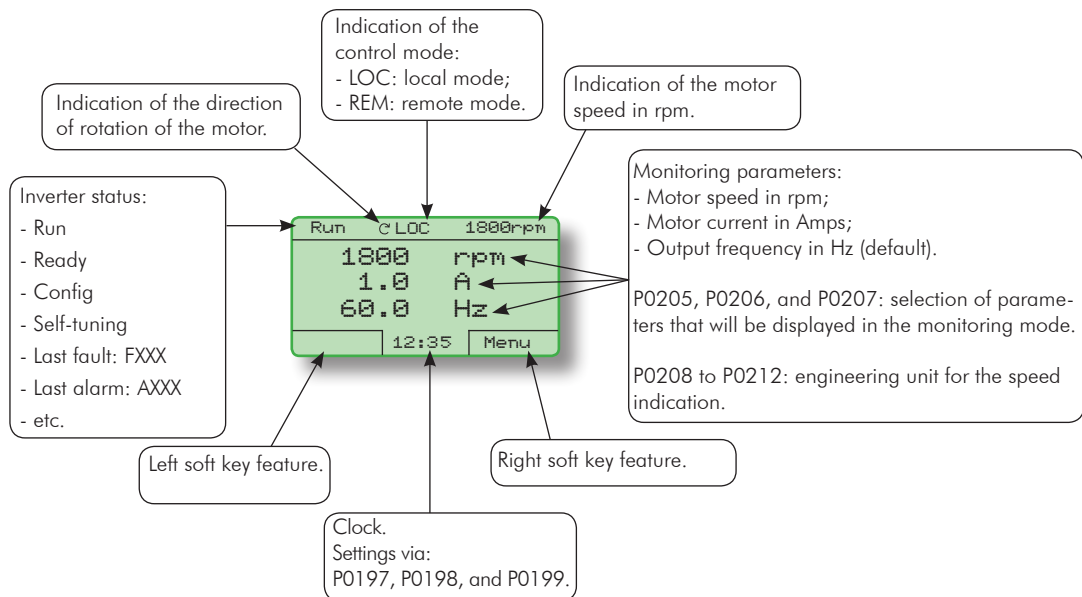

(a) Monitoring screen with the factory default settings

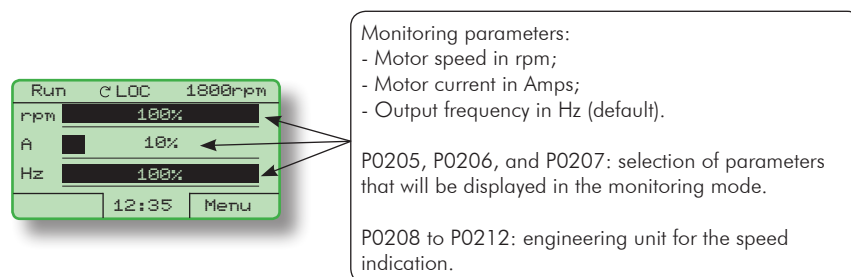

(b) Example of a monitoring screen with bar graphs

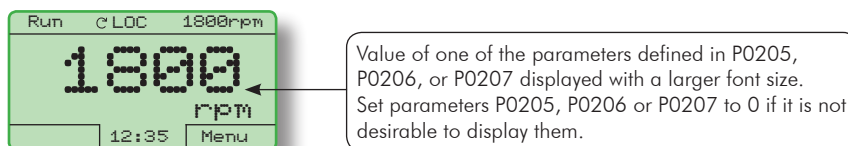

(c) Example of a monitoring screen displaying a parameter with a larger font size

Figure 4.3 - Keypad monitoring modes

## 4.2 PARAMETERS ORGANIZATION

When the right soft key ("MENU") is pressed in the monitoring mode, the display shows the first 4 groups of parameters. An example of how the groups of parameters are organized is presented in table 4.1. The number and name of the groups may change depending on the firmware version used. For further details on the existent groups for the firmware version used, please refer to the Software Manual.

Table 4.1 - Groups of parameters

Level 0	Level 1		Level 2		Level 3			
Monitoring	00	ALL PARAMETERS						
	01	PARAMETER GROUPS	20	Ramps				
			21	Speed References				
			22	Speed Limits				
			23	V/f Control				
			24	Adjust. V/f Curve				
			25	VVW Control				
			26	V/f Current Limit.				
			27	V/f DC Volt.Limit.				
			28	Dynamic Braking				
			29	Vector Control	90	Speed Regulator		
			91		Current Regulator			
			92		Flux Regulator			
			93		I/F Control			
			94		Self-Tuning			
			95		Torque Curr.Limit.			
			96		DC Link Regulator			
			30	HMI				
			31	Local Command				
			32	Remote Command				
			33	3-Wire Command				
			34	FWD/REV Run Comm.				
			35	Zero Speed Logic				
			36	Multispeed				
			37	Electr. Potentiom.				
			38	Analog Inputs				
			39	Analog Outputs				
			40	Digital Inputs				
			41	Digital Outputs				
			42	Inverter Data				
			43	Motor Data				
			44	FlyStart/RideThru				
			45	Protections				
			46	PID Regulator				
			47	DC Braking				
			48	Skip Speed				
			49	Communication	110	Local/Rem Config.		
			111		Status/Commands			
			112		CANopen/DeviceNet			
			113		Serial RS232/485			
			114		Anybus			
			115		Profibus DP			
			50	SoftPLC				
			51	PLC				
			52	Trace Function				
			02	ORIENTED START-UP				
			03	CHANGED PARAMETERS				
			04	BASIC APPLICATION				
			05	SELF-TUNING				
			06	BACKUP PARAMETERS				
	07	I/O CONFIGURATION	38	Analog Inputs				
			39	Analog Outputs				
40			Digital Inputs					
41			Digital Outputs					
08	FAULT HISTORY							
09	READ ONLY PARAMS.							

## FIRST TIME POWER-UP AND START-UP

This chapter describes how to:

- Check and prepare the inverter before power-up.
- Power-up the inverter and check the result.
- Set the inverter for the operation in the V/f mode based on the power supply and motor information by using the Oriented Start-Up routine and the Basic Application group.

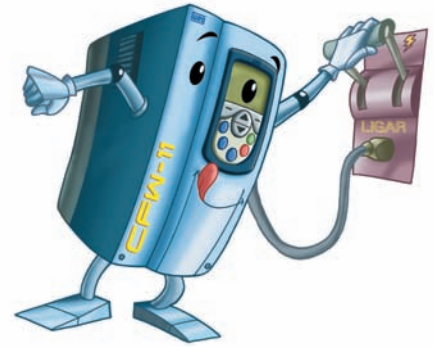

### NOTE!

For a detailed description of the VVW or Vector control modes and for other available functions, please refer to the CFW-11 Software Manual.

## 5.1 PREPARE FOR START-UP

The inverter shall have been already installed according to the recommendations listed in Chapter 3 – Installation and Connection. The following recommendations are applicable even if the application design is different from the suggested control connections.



### DANGER!

Always disconnect the main power supply before performing any inverter connection.

- 1) Check if power, grounding, and control connections are correct and firmly secured.
- 2) Remove from the inside of the inverter all installation material left behind.
- 3) Verify the motor connections and if the motor voltage and current is within the rated value of the inverter.
- 4) Mechanically uncouple the motor from the load:  
If the motor cannot be uncoupled, make sure that the chosen direction of rotation (forward or reverse) will not result in personnel injury and/or equipment damage.
- 5) Return the inverter covers.
- 6) Measure the power supply voltage and verify if it is within the range listed in chapter 8.
- 7) Apply power to the input:  
Close the input disconnect switch.
- 8) Check the result of the first time power-up:  
The keypad should display the standar monitoring mode (figure 4.3 (a)) and the status LED should be steady green.

## 5.2 START-UP

The start-up procedure for the V/f is described in three simple steps by using the **Oriented Start-up routine** and the **Basic Application group**.

**Steps:**

- (1) Set the password for parameter modification.
- (2) Execute the **Oriented Start-up routine**.
- (3) Set the parameters of the **Basic Application group**.

### 5.2.1 Password Setting in P0000

Step	Action/Result	Display indication
1	- Monitoring Mode. - Press "Menu" (right soft key).	
2	- Group "00 ALL PARAMETERS" is already selected. - Press "Select".	
3	- Parameter "Access to Parameters P0000: 0" is already selected. - Press "Select".	
4	- To set the password, press the Up Arrow until number 5 is displayed in the keypad.	
5	- When number 5 is displayed in the keypad, press "Save".	
6	- If the setting has been properly performed, the keypad should display "Access to Parameters P0000: 5". - Press "Return" (left soft key).	
7	- Press "Return".	
8	- The display returns to the Monitoring Mode.	

Figure 5.1 - Steps for allowing parameters modification via P0000

### 5.2.2 Oriented Start-Up

There is a group of parameters named "Oriented Start-up" that makes the inverter settings easier. Inside this group, there is a parameter – P0317 – that shall be set to enter into the Oriented Start-up routine.

The Oriented Start-up routine allows you to quickly set up the inverter for operation with the line and motor used. This routine prompts you for the most commonly used parameters in a logic sequence.

In order to enter into the Oriented Start-up routine, follow the steps presented in figure 5.2, first modifying parameter P0317 to 1 and then, setting all remaining parameters as they are prompted in the display.

The use of the Oriented Start-up routine for setting the inverter parameters may lead to the automatic modification of other internal parameters and/or variables of the inverter.

During the Oriented Start-up routine, the message "Config" will be displayed at the left top corner of the keypad.

Step	Action/Result	Display indication
1	- Monitoring Mode. - Press "Menu" (right soft key).	
2	- Group "00 ALL PARAMETERS" has been already selected. 	
3	- Group "01 PARAMETER GROUPS" is selected. 	
4	- Group "02 ORIENTED START-UP" is then selected. - Press "Select".	
5	- Parameter "Oriented Start-Up P0317: No" has been already selected. - Press "Select".	
6	- The value of "P0317 = [000] No" is displayed. 	
7	- The parameter value is modified to "P0317 = [001] Yes". - Press "Save".	
8	- At this point the Oriented Start-up routine starts and the "Config" status is displayed at the top left corner of the keypad. - The parameter "Language P0201: English" is already selected. - If needed, change the language by pressing "Select". Then, press  or  to scroll through the available options and press "Save" to select a different language. 	
9	- If needed, change the value of P0202 according to the type of control. To do so, press "Select". - The settings listed here are valid only for P0202=0 (V/f 60 Hz) or P0202=1 (V/f 50 Hz). For other options (Adjustable V/f, VVW, or Vector modes), please refer to the Software Manual. 	

Figure 5.2 - Oriented Start-up



# First Time Power-Up and Start-Up











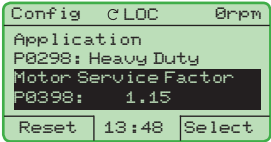

Step	Action/Result	Display indication
10	<p>- If needed, change the value of P0296 according to the line rated voltage. To do so, press <b>"Select"</b>. This modification will affect P0151, P0153, P0185, P0321, P0322, P0323, and P0400.</p> 	
11	<p>- If needed, change the value of P0298 according to the inverter application. To do so, press <b>"Select"</b>. This modification will affect P0156, P0157, P0158, P0401, P0404 and P0410 (this last one only if P0202 = 0, 1, or 2 – V/f control). The time and the activation level of the overload protection will be affected as well.</p> 	
12	<p>- If needed, change the value of P0398 according to the motor service factor. To do so, press <b>"Select"</b>. This modification will affect the current value and the activation time of the motor overload function.</p> 	
13	<p>- If needed, change the value of P0400 according to the motor rated voltage. To do so, press <b>"Select"</b>. This modification adjusts the output voltage by a factor <math>x = P0400/P0296</math>.</p> 	
14	<p>- If needed, change the value of P0401 according to the motor rated current. To do so, press <b>"Select"</b>. This modification will affect P0156, P0157, P0158, and P0410.</p> 	
15	<p>- If needed, set P0402 according to the motor rated speed. To do so, press <b>"Select"</b>. This modification affects P0122 to P0131, P0133, P0134, P0135, P0182, P0208, P0288, and P0289.</p> 	
16	<p>- If needed, set P0403 according to the motor rated frequency. To do so, press <b>"Select"</b>. This modification affects P0402.</p> 	
17	<p>- If needed, change the value of P0404 according to the motor rated power. To do so, press <b>"Select"</b>. This modification affects P0410.</p> 	
18	<p>- <u>This parameter will only be visible if the encoder board ENC1 is installed in the inverter.</u> - If there is an encoder connected to the motor, set P0405 according to the encoder pulses number. To do so, press <b>"Select"</b>.</p> 	
19	<p>- If needed, set P0406 according to the motor ventilation. To do so, press <b>"Select"</b>. - To complete the Oriented Start-Up routine, press <b>"Reset"</b> (left soft key) or .</p>	
20	<p>- After few seconds, the display returns to the Monitoring Mode.</p>	

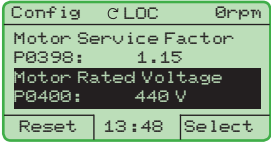
Figure 5.2 (cont.) - Oriented Start-up

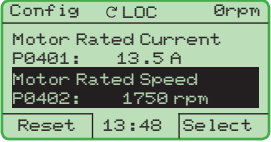
5.2.3 Setting Basic Application Parameters

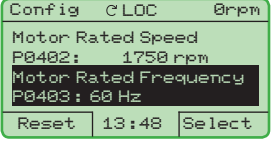
After running the Oriented Start-up routine and properly setting the parameters, the inverter is ready to operate in the V/f mode.

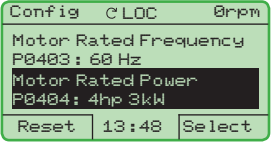
The inverter has a number of other parameters that allow its adaptation to the most different applications. This manual presents some basic parameters that shall be set in most cases. There is a group named “Basic Application” to make this task easier. A summary of the parameters inside this group is listed in table 5.1. There is also a group of read only parameters that shows the value of the most important inverter variables such as voltage, current, etc. The main parameters comprised in this group are listed in table 5.2. For further details, please refer to the CFW-11 Software Manual.

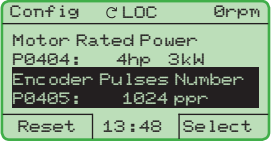
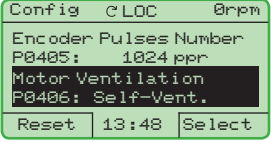
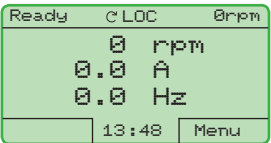
Follow steps outlined in figure 5.3 to set the parameters of the Basic Application group.

The procedure for start-up in the V/f operation mode is finished after setting these parameters.

Step	Action/Result	Display indication
1	- Monitoring Mode. - Press “Menu” (right soft key).	
2	- Group “00 ALL PARAMETERS” has been already selected. 	
3	- Group “01 PARAMETER GROUPS” is then selected. 	
4	- Group “02 ORIENTED START-UP” is then selected. 	
5	- Group “03 CHANGED PARAMETERS” is selected. 	
6	- Group “04 BASIC APPLICATION” is selected. - Press “Select”.	
7	- Parameter “Acceleration Time P0100: 20.0 s” has been already selected. - If needed, set P0100 according to the desired acceleration time. To do so, press “Select”. - Proceed similarly until all parameters of group “04 BASIC APPLICATION” have been set. When finished, press “Return” (left soft key).	
8	- Press “Return”.	
9	- The display returns to the Monitoring Mode and the inverter is ready to run.	

Figure 5.3 - Setting parameters of the Basic Application group

# First Time Power-Up and Start-Up

Table 5.1 - Parameters comprised in the Basic Application group

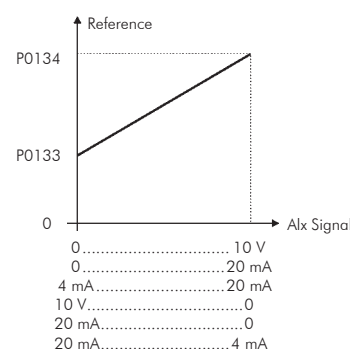
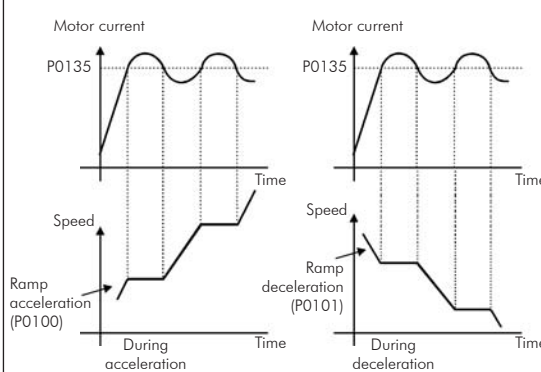
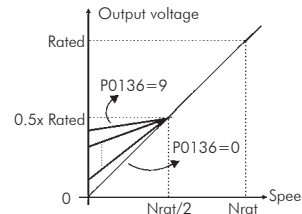
Parameter	Name	Description	Setting Range	Factory Setting	User Setting
P0100	Acceleration Time	- Defines the time to linearly accelerate from 0 up to the maximum speed (P0134). - If set to 0.0 s, it means no acceleration ramp.	0.0 to 999.0 s	20.0 s	
P0101	Deceleration Time	- Defines the time to linearly decelerate from the maximum speed (P0134) up to 0. - If set to 0.0 s, it means no deceleration ramp.	0.0 to 999.0 s	20.0 s	
P0133	Minimum Speed	- Defines the minimum and maximum values of the speed reference when the drive is enabled. - These values are valid for any reference source.	0 to 18000 rpm	90 rpm (60 Hz motor) 75 rpm (50 Hz motor)	
P0134	Maximum Speed		0 to 18000 rpm	1800 rpm (60 Hz motor) 1500 rpm (50 Hz motor)	
P0135	Max. Output Current	- Avoids motor stall under torque overload condition during the acceleration or deceleration. - The factory default setting is for "Ramp Hold": if the motor current exceeds the value set at P0135 during the acceleration or deceleration, the motor speed will not be increased (acceleration) or decreased (deceleration) anymore. When the motor current reaches a value below the programmed in P0135, the motor speed is again increased or decreased. - Other options for the current limitation are available. Refer to the CFW-11 Software Manual.	$0.2 \times I_{rat-HD}$ to $2 \times I_{rat-HD}$	$1.5 \times I_{rat-HD}$	
					
P0136	Manual Torque Boost	- Operates in low speeds, modifying the output voltage x frequency curve to keep the torque constant. - Compensates the voltage drop at the motor stator resistance. This function operates in low speeds increasing the inverter output voltage to keep the torque constant in the V/f mode. - The optimal setting is the smallest value of P0136 that allows the motor to start satisfactorily. An excessive value will considerably increase the motor current in low speeds, and may result in a fault (F048, F051, F071, F072, F078 or F183) or alarm (A046, A047, A050 or A110) condition.	0 to 9	1	
					

5

Table 5.2 - Main read only parameters

Parameter	Description	Setting Range
P0001	Speed Reference	0 to 18000 rpm
P0002	Motor Speed	0 to 18000 rpm
P0003	Motor Current	0.0 to 4500.0 A
P0004	DC Link Voltage (Ud)	0 to 2000 V
P0005	Motor Frequency	0.0 to 300.0 Hz
P0006	VFD Status	0 = Ready 1 = Run 2 = Undervoltage 3 = Fault 4 = Self-tuning 5 = Configuration 6 = DC-Braking 7 = STO
P0007	Motor Voltage	0 to 2000 V
P0009	Motor Torque	-1000.0 to 1000.0 %
P0010	Output Power	0.0 to 6553.5 kW
P0012	DI8 to DI1 Status	0000h to 00FFh
P0013	DO5 to DO1 Status	0000h to 001Fh
P0018	AI1 Value	-100.00 to 100.00 %
P0019	AI2 Value	-100.00 to 100.00 %
P0020	AI3 Value	-100.00 to 100.00 %
P0021	AI4 Value	-100.00 to 100.00 %
P0023	Software Version	0.00 to 655.35
P0027	Accessories Config. 1	Hexadecimal code representing the identified accessories. Refer to chapter 7.
P0028	Accessories Config. 2	
P0029	Power Hardware Config.	Hexadecimal code according to the available models and option kits. Refer to the software manual for a complete code list.
P0030	IGBTs Temperature U	-20.0 to 150.0 °C (-4 °F to 302 °F)
P0031	IGBTs Temperature V	-20.0 to 150.0 °C (-4 °F to 302 °F)
P0032	IGBTs Temperature W	-20.0 to 150.0 °C (-4 °F to 302 °F)
P0033	Rectifier Temperature	-20.0 to 150.0 °C (-4 °F to 302 °F)
P0034	Internal Air Temp.	-20.0 to 150.0 °C (-4 °F to 302 °F)
P0036	Fan Heatsink Speed	0 to 15000 rpm
P0037	Motor Overload Status	0 to 100 %
P0038	Encoder Speed	0 to 65535 rpm
P0040	PID Process Variable	0.0 to 100.0 %
P0041	PID Setpoint Value	0.0 to 100.0 %
P0042	Time Powered	0 to 65535h
P0043	Time Enabled	0.0 to 6553.5h
P0044	kWh Output Energy	0 to 65535 kWh
P0045	Fan Enabled Time	0 to 65535h
P0048	Present Alarm	0 to 999
P0049	Present Fault	0 to 999

Parameter	Description	Setting Range
P0050	Last Fault	0 to 999
P0051	Last Fault Day/Month	00/00 to 31/12
P0052	Last Fault Year	00 to 99
P0053	Last Fault Time	00:00 to 23:59
P0054	Second Fault	0 to 999
P0055	Second Flt. Day/Month	00/00 to 31/12
P0056	Second Fault Year	00 to 99
P0057	Second Fault Time	00:00 to 23:59
P0058	Third Fault	0 to 999
P0059	Third Fault Day/Month	00/00 to 31/12
P0060	Third Fault Year	00 to 99
P0061	Third Fault Time	00:00 to 23:59
P0062	Fourth Fault	0 to 999
P0063	Fourth Flt. Day/Month	00/00 to 31/12
P0064	Fourth Fault Year	00 to 99
P0065	Fourth Fault Time	00:00 to 23:59
P0066	Fifth Fault	0 to 999
P0067	Fifth Fault Day/Month	00/00 to 31/12
P0068	Fifth Fault Year	00 to 99
P0069	Fifth Fault Time	00:00 to 23:59
P0070	Sixth Fault	0 to 999
P0071	Sixth Fault Day/Month	00/00 to 31/12
P0072	Sixth Fault Year	00 to 99
P0073	Sixth Fault Time	00:00 to 23:59
P0074	Seventh Fault	0 to 999
P0075	Seventh Flt. Day/Month	00/00 to 31/12
P0076	Seventh Fault Year	00 to 99
P0077	Seventh Fault Time	00:00 to 23:59
P0078	Eighth Fault	0 to 999
P0079	Eighth Flt. Day/Month	00/00 to 31/12
P0080	Eighth Fault Year	00 to 99
P0081	Eighth Fault Time	00:00 to 23:59
P0082	Ninth Fault	0 to 999
P0083	Ninth Fault Day/Month	00/00 to 31/12
P0084	Ninth Fault Year	00 to 99
P0085	Ninth Fault Time	00:00 to 23:59
P0086	Tenth Fault	0 to 999
P0087	Tenth Fault Day/Month	00/00 to 31/12
P0088	Tenth Fault Year	00 to 99
P0089	Tenth Fault Time	00:00 to 23:59
P0090	Current At Last Fault	0.0 to 4000.0 A
P0091	DC Link At Last Fault	0 to 2000 V
P0092	Speed At Last Fault	0 to 18000 rpm
P0093	Reference Last Fault	0 to 18000 rpm
P0094	Frequency Last Fault	0.0 to 300.0 Hz
P0095	Motor Volt. Last Fault	0 to 2000 V
P0096	DIx Status Last Fault	0000h to 00FFh
P0097	DOx Status Last Fault	0000h to 001Fh

### 5.3 SETTING DATE AND TIME

Step	Action/Result	Display indication	Step	Action/Result	Display indication
1	Monitoring Mode. - Press "Menu" (right soft key).		6	- Parameter "Day P0194" is already selected. - If needed, set P0194 according to the actual day. To do so, press "Select" and then,  or  to change P0194 value. - Follow the same steps to set parameters "Month P0195" to "Seconds P0199".	
2	- Group "00 ALL PARAMETERS" is already selected.		7	- Once the setting of P0199 is over, the Real Time Clock is now updated. - Press "Return" (left soft key).	
3	- Group "01 PARAMETER GROUPS" is selected. - Press "Select"		8	- Press "Return".	
4	- A new list of groups is displayed and group "20 Ramps" is selected. - Press  until you reach group "30 HMI".		9	- Press "Return".	
5	- Group "30 HMI" is selected. - Press "Select".		10	- The display is back to the Monitoring Mode.	

Figure 5.4 - Setting date and time

### 5.4 BLOCKING PARAMETERS MODIFICATION

To prevent unauthorized or unintended parameters modification, parameter P0000 should be set to a value different from 5. Follow the same procedures described in item 5.2.1.

## 5.5 HOW TO CONNECT A PC



### NOTES!

- Always use a standard host/device shielded USB cable. Unshielded cables may lead to communication errors.
- Recommended cables: Samtec:  
USBC-AM-MB-B-B-S-1 (1 meter);  
USBC-AM-MB-B-B-S-2 (2 meters);  
USBC-AM-MB-B-B-S-3 (3 meters).
- The USB connection is galvanically isolated from the mains power supply and from other high voltages internal to the inverter. However, the USB connection is not isolated from the Protective Ground (PE). Use an isolated notebook for the USB connection or a desktop connected to the same Protective Ground (PE) of the inverter.

Install the SuperDrive G2 software to control motor speed, view, or edit inverter parameters through a personal computer (PC).

Basic procedures for transferring data from the PC to the inverter:

1. Install the SuperDrive G2 software in the PC;
2. Connect the PC to the inverter through a USB cable;
3. Start SuperDrive G2;
4. Choose "Open" and the files stored in the PC will be displayed;
5. Select the file;
6. Use the command "Write Parameters to the Drive".

All parameters are now transferred to the inverter.

For further information on SuperDrive G2 software, please refer SuperDrive Manual.

## 5.6 FLASH MEMORY MODULE

Location as presented in figure 2.2 item G.

### Features:

- Store a copy of the inverter parameters;
- Transfer parameters stored in the FLASH memory to the inverter;
- Transfer firmware stored in the FLASH memory to the inverter;
- Store programs created by the SoftPLC.

Whenever the inverter is powered up, this program is transferred to the RAM memory located in the inverter control board and executed.

Refer to the CFW-11 Software Manual and to SoftPLC Manual for further details.



### ATTENTION!

Before installing or removing the FLASH memory module, disconnect the inverter power supply and wait for the complete discharge of the capacitors.



## TROUBLESHOOTING AND MAINTENANCE

This chapter:

- Lists all faults and alarms that may occur.
- Indicates the possible causes of each fault and alarm.
- Lists most frequent problems and corrective actions.
- Presents instructions for periodic inspections and preventive maintenance in the equipment.

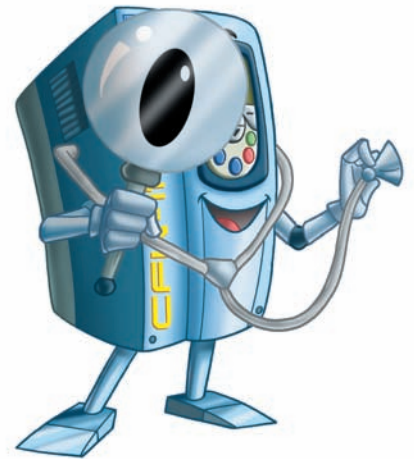

### 6.1 OPERATION OF THE FAULTS AND ALARMS

When a fault is detected ("FAULT" (FXXX)):

- The PWM pulses are blocked;
- The keypad displays the "FAULT" code and description;
- The "STATUS" LED starts flashing red;
- The output relay set to "NO FAULT" opens;
- Some control circuitry data is saved in the EEPROM memory:
  - Keypad and EP (Electronic Pot) speed references, in case the function "Reference backup" is enabled in P0120;
  - The "FAULT" code that occurred (shifts the last nine previous faults and alarms);
  - The state of the motor overload function integrator;
  - The state of the operating hours counter (P0043) and the powered-up hours counter (P0042).

Reset the inverter to return the drive to a "READY" condition in the event of a "FAULT". The following reset options are available:

- Removing the power supply and reapplying it (power-on reset);
- Pressing the operator key  (manual reset);
- Through the "Reset" soft key;
- Automatically by setting P0206 (auto-reset);
- Through a digital input: DIx=20 (P0263 to P0270).

When an alarm situation ("ALARM" (AXXX)) is detected:

- The keypad displays the "ALARM" code and description;
- The "STATUS" LED changes to yellow;
- The PWM pulses are not blocked (the inverter is still operating).



## 6.2 FAULTS, ALARMS, AND POSSIBLE CAUSES

Table 6.1 - "Faults", "Alarms", and Possible Causes

Fault/Alarm	Description	Possible Causes
F006: Imbalance or Input Phase Loss	Mains voltage imbalance too high or phase missing in the input power supply. <b>Note:</b> - If the motor is unloaded or operating with reduced load this fault may not occur. - Fault delay is set at parameter P0357. P0357=0 disables the fault.	<input checked="" type="checkbox"/> Phase missing at the inverter's input power supply. <input checked="" type="checkbox"/> Input voltage imbalance >5 %.
A010: Rectifier High Temperature	A high temperature alarm was detected by the NTC temperature sensors located in the rectifier modules. <b>Note:</b> - This is valid only for the following models: CFW110086T2, CFW110105T2, CFW110045T4, CFW110058T4, CFW110070T4 and CFW110088T4. - It may be disabled by setting P0353=2 or 3.	<input checked="" type="checkbox"/> Surrounding air temperature is too high (>50 °C (122 °F)) and output current is too high. <input checked="" type="checkbox"/> Blocked or defective fan. <input checked="" type="checkbox"/> Inverter heatsink is completely covered with dust.
F011: Rectifier Overtemperature	An overtemperature fault was detected by the NTC temperature sensors located in the rectifier modules. <b>Note:</b> - This is valid only for the following models: CFW110086T2, CFW110105T2, CFW110045T4, CFW110058T4, CFW110070T4 and CFW110088T4.	
F021: DC Bus Undervoltage	DC bus undervoltage condition occurred.	<input checked="" type="checkbox"/> The input voltage is too low and the DC bus voltage dropped below the minimum permitted value (monitor the value at Parameter P0004): Ud < 223 V - For a 200-240 V three-phase input voltage Ud < 170 V - For a 200-240 V single-phase input voltage (models CFW11XXXXS2 or CFW11XXXXB2) (P0296=0); Ud < 385 V - For a 380 V input voltage (P0296=1); Ud < 405 V - For a 400-415 V input voltage (P0296=2); Ud < 446 V - For a 440-460 V input voltage (P0296=3); Ud < 487 V - For a 480 V input voltage (P0296=4). <input checked="" type="checkbox"/> Phase loss in the input power supply. <input checked="" type="checkbox"/> Pre-charge circuit failure. <input checked="" type="checkbox"/> Parameter P0296 was set to a value above of the power supply rated voltage.
F022: DC Bus Overvoltage	DC bus overvoltage condition occurred.	<input checked="" type="checkbox"/> The input voltage is too high and the DC bus voltage surpassed the maximum permitted value: Ud > 400 V - For 220-230 V input models (P0296=0); Ud > 800 V - For 380-480 V input models (P0296=1, 2, 3, or 4). <input checked="" type="checkbox"/> Inertia of the driven-load is too high or deceleration time is too short. <input checked="" type="checkbox"/> Wrong settings for parameters P0151, or P0153, or P0185.
F030: Power Module U Fault	Desaturation of IGBT occurred in Power Module U. <b>Note:</b> This protection is available only for frame D models.	<input checked="" type="checkbox"/> Short-circuit between motor phases U and V or U and W.
F034: Power Module V Fault	Desaturation of IGBT occurred in Power Module V. <b>Note:</b> This protection is available only for frame D models.	<input checked="" type="checkbox"/> Short-circuit between motor phases V and U or V and W.
F038: Power Module W Fault	Desaturation of IGBT occurred in Power Module W. <b>Note:</b> This protection is available only for frame D models.	<input checked="" type="checkbox"/> Short-circuit between motor phases W and U or W and V.
F042: DB IGBT Fault	Desaturation of Dynamic Braking IGBT occurred. <b>Note:</b> This protection is available only for frame D models.	<input checked="" type="checkbox"/> Short-circuit between the connection cables of the dynamic braking resistor.

**Table 6.1 (cont.)** - "Faults", "Alarms", and Possible Causes

Fault/Alarm	Description	Possible Causes
A046: High Load on Motor	Load is too high for the used motor. <b>Note:</b> It may be disabled by setting P0348=0 or 2.	<input checked="" type="checkbox"/> Settings of P0156, P0157, and P0158 are too low for the used motor. <input checked="" type="checkbox"/> Motor shaft load is excessive.
A047: IGBT Overload Alarm	An IGBT overload alarm occurred. <b>Note:</b> It may be disabled by setting P0350=0 or 2.	<input checked="" type="checkbox"/> Inverter output current is too high.
F048: IGBT Overload Fault	An IGBT overload fault occurred. <b>Note:</b> It may be disabled by setting P0350=0 or 2.	<input checked="" type="checkbox"/> Inverter output current is too high.
A050: IGBT High Temperature	A high temperature alarm was detected by the NTC temperature sensors located on the IGBTs. <b>Note:</b> It may be disabled by setting P0353=2 or 3.	<input checked="" type="checkbox"/> Surrounding air temperature is too high (>50 °C (122 °F)) and output current is too high. <input checked="" type="checkbox"/> Blocked or defective fan. <input checked="" type="checkbox"/> Inverter heatsink is completely covered with dust.
F051: IGBT Overtemperature	A high temperature fault was detected by the NTC temperature sensors located on the IGBTs.	
F067: Incorrect Encoder/ Motor Wiring	Fault related to the phase relation of the encoder signals. <b>Note:</b> - This fault can only happen during the self-tuning routine. - It is not possible to reset this fault. - In this case, turn off the power supply, solve the problem, and then turn it on again.	<input checked="" type="checkbox"/> Output motor cables U, V, W are inverted. <input checked="" type="checkbox"/> Encoder channels A and B are inverted. <input checked="" type="checkbox"/> Encoder was not properly mounted.
F070: Overcurrent / Short-circuit	Overcurrent or short-circuit detected at the output, in the DC bus, or at the braking resistor. <b>Note:</b> It is available only for models of frames A, B, and C.	<input checked="" type="checkbox"/> Short-circuit between two motor phases. <input checked="" type="checkbox"/> Short-circuit between the connection cables of the dynamic braking resistor. <input checked="" type="checkbox"/> IGBT modules are shorted.
F071: Output Overcurrent	The inverter output current was too high for too long.	<input checked="" type="checkbox"/> Excessive load inertia or acceleration time too short. <input checked="" type="checkbox"/> Settings of P0135, P0169, P0170, P0171, and P0172 are too high.
F072: Motor Overload	The motor overload protection operated. <b>Note:</b> It may be disabled by setting P0348=0 or 3.	<input checked="" type="checkbox"/> Settings of P0156, P0157, and P0158 are too low for the used motor. <input checked="" type="checkbox"/> Motor shaft load is excessive.
F074: Ground Fault	A ground fault occurred either in the cable between the inverter and the motor or in the motor itself. <b>Note:</b> It may be disabled by setting P0343=0.	<input checked="" type="checkbox"/> Shorted wiring in one or more of the output phases. <input checked="" type="checkbox"/> Motor cable capacitance is too large, resulting in current peaks at the output. <sup>(1)</sup>
F076: Motor Current Imbalance	Fault of motor current imbalance. <b>Note:</b> It may be disabled by setting P0342=0.	<input checked="" type="checkbox"/> Loose connection or broken wiring between the motor and inverter connection. <input checked="" type="checkbox"/> Vector control with wrong orientation. <input checked="" type="checkbox"/> Vector control with encoder, encoder wiring or encoder motor connection inverted.
F077: DB Resistor Overload	The dynamic braking resistor overload protection operated.	<input checked="" type="checkbox"/> Excessive load inertia or deceleration time too short. <input checked="" type="checkbox"/> Motor shaft load is excessive. <input checked="" type="checkbox"/> Wrong settings for parameters P0154 and P0155.
F078: Motor Overtemperature	Fault related to the PTC temperature sensor installed in the motor. <b>Note:</b> - It may be disabled by setting P0351=0 or 3. - It is required to set the analog input / output to the PTC function.	<input checked="" type="checkbox"/> Excessive load at the motor shaft. <input checked="" type="checkbox"/> Excessive duty cycle (too many starts / stops per minute). <input checked="" type="checkbox"/> Surrounding air temperature too high. <input checked="" type="checkbox"/> Loose connection or short-circuit (resistance < 100 Ω) in the wiring connected to the motor thermistor. <input checked="" type="checkbox"/> Motor thermistor is not installed. <input checked="" type="checkbox"/> Blocked motor shaft.
F079: Encoder Signal Fault	Lack of encoder signals.	<input checked="" type="checkbox"/> Broken wiring between motor encoder and option kit for encoder interface. <input checked="" type="checkbox"/> Defective encoder.

**Table 6.1 (cont.)** - "Faults", "Alarms", and Possible Causes

Fault/Alarm	Description	Possible Causes
F080: CPU Watchdog	Microcontroller watchdog fault.	<input checked="" type="checkbox"/> Electrical noise.
F082: Copy Function Fault	Fault while copying parameters.	<input checked="" type="checkbox"/> An attempt to copy the keypad parameters to an inverter with a different firmware version.
F084: Auto-diagnosis Fault	Auto-diagnosis fault.	<input checked="" type="checkbox"/> Defect in the inverter internal circuitry.
A088: Keypad Comm. Fault	Indicates a problem between the keypad and control board communication.	<input checked="" type="checkbox"/> Loose keypad cable connection. <input checked="" type="checkbox"/> Electrical noise in the installation.
A090: External Alarm	External alarm via digital input. <b>Note:</b> It is required to set a digital input to "No external alarm".	<input checked="" type="checkbox"/> Wiring was not connected to the digital input (DI1 to DI8) set to "No external alarm".
F091: External Fault	External fault via digital input. <b>Note:</b> It is required to set a digital input to "No external fault".	<input checked="" type="checkbox"/> Wiring was not connected to the digital input (DI1 to DI8) set to "No external fault".
F099: Invalid Current Offset	Current measurement circuit is measuring a wrong value for null current.	<input checked="" type="checkbox"/> Defect in the inverter internal circuitry.
A110: High Motor Temperature	Alarm related to the PTC temperature sensor installed in the motor. <b>Note:</b> - It may be disabled by setting P0351=0 or 2. - It is required to set the analog input / output to the PTC function.	<input checked="" type="checkbox"/> Excessive load at the motor shaft. <input checked="" type="checkbox"/> Excessive duty cycle (too many starts / stops per minute). <input checked="" type="checkbox"/> Surrounding air temperature too high. <input checked="" type="checkbox"/> Loose connection or short-circuit (resistance < 100 Ω) in the wiring connected to the motor thermistor. <input checked="" type="checkbox"/> Motor thermistor is not installed. <input checked="" type="checkbox"/> Blocked motor shaft.
A128: Timeout for Serial Communication	Indicates that the inverter stopped receiving valid messages within a certain time interval. <b>Note:</b> It may be disabled by setting P0314=0.0 s.	<input checked="" type="checkbox"/> Check the wiring and grounding installation. <input checked="" type="checkbox"/> Make sure the inverter has sent a new message within the time interval set at P0314.
A129: Anybus is Offline	Alarm that indicates interruption of the Anybus-CC communication.	<input checked="" type="checkbox"/> PLC entered into the idle state. <input checked="" type="checkbox"/> Programming error. Master and slave set with a different number of I/O words. <input checked="" type="checkbox"/> Communication with master has been lost (broken cable, unplugged connector, etc.).
A130: Anybus Access Error	Alarm that indicates an access error to the Anybus-CC communication module.	<input checked="" type="checkbox"/> Defective, unrecognized, or improperly installed Anybus-CC module. <input checked="" type="checkbox"/> Conflict with a WEG option board.
A133: CAN Not Powered	Alarm indicating that the power supply was not connected to the CAN controller.	<input checked="" type="checkbox"/> Broken or loose cable. <input checked="" type="checkbox"/> Power supply is off.
A134: Bus Off	Inverter CAN interface has entered into the bus-off state.	<input checked="" type="checkbox"/> Incorrect communication baud-rate. <input checked="" type="checkbox"/> Two nodes configured with the same address in the network. <input checked="" type="checkbox"/> Wrong cable connection (inverted signals).
A135: CANopen Communication Error	Alarm that indicates a communication error.	<input checked="" type="checkbox"/> Communication problems. <input checked="" type="checkbox"/> Wrong master configuration/settings. <input checked="" type="checkbox"/> Incorrect configuration of the communication objects.
A136: Idle Master	Network master has entered into the idle state.	<input checked="" type="checkbox"/> PLC in IDLE mode. <input checked="" type="checkbox"/> Bit of the PLC command register set to zero (0).
A137: DNet Connection Timeout	I/O connection timeout - DeviceNet communication alarm.	<input checked="" type="checkbox"/> One or more allocated I/O connections have entered into the timeout state.
F150: Motor Overspeed	Overspeed fault. It is activated when the real speed exceeds the value of P0134+P0132 for more than 20 ms.	<input checked="" type="checkbox"/> Wrong settings of P0161 and/or P0162. <input checked="" type="checkbox"/> Problem with the hoist-type load.
F151: FLASH Memory Module Fault	FLASH Memory Module fault (MMF-01).	<input checked="" type="checkbox"/> Defective FLASH memory module. <input checked="" type="checkbox"/> Check the connection of the FLASH memory module.

Table 6.1 (cont.) - "Faults", "Alarms", and Possible Causes

Fault/Alarm	Description	Possible Causes
A152: Internal Air High Temperature	Alarm indicating that the internal air temperature is too high. <b>Note:</b> It may be disabled by setting P0353=1 or 3.	<input checked="" type="checkbox"/> Surrounding air temperature too high (>50 °C (122 °F)) and excessive output current. <input checked="" type="checkbox"/> Defective internal fan (if installed).
F153: Internal Air Overtemperature	Internal air overtemperature fault.	
F156: Undertemperature	Undertemperature fault (below -30 °C (-22 °F)) in the IGBT or rectifier measured by the temperature sensors.	<input checked="" type="checkbox"/> Surrounding air temperature ≤ -30 °C (-22 °F).
A177: Fan Replacement	Fan replacement alarm (P0045 > 50000 hours). <b>Note:</b> This function may be disabled by setting P0354=0.	<input checked="" type="checkbox"/> Maximum number of operating hours for the heatsink fan has been reached.
F179: Heatsink Fan Speed Fault	This fault indicates a problem with the heatsink fan. <b>Note:</b> This function may be disabled by setting P0354=0.	<input checked="" type="checkbox"/> Dust on fan blades and bearings. <input checked="" type="checkbox"/> Defective fan.
A181: Invalid Clock Value	Invalid clock value alarm.	<input checked="" type="checkbox"/> It is necessary to set date and time at parameters P0194 to P0199. <input checked="" type="checkbox"/> Keypad battery is discharged, defective, or not installed.
F182: Pulse Feedback Fault	Indicates a fault on the output pulses feedback.	<input checked="" type="checkbox"/> Defect in the inverter internal circuitry.
F183: IGBT overload + Temperature	Overtemperature related to the IGBTs overload protection.	<input checked="" type="checkbox"/> Surrounding air temperature too high. <input checked="" type="checkbox"/> Operation with frequencies < 10 Hz under overload.

**Note:**

(1) Long motor cables (with more than 100 meters) will have a high leakage capacitance to the ground. The circulation of leakage currents through these capacitances may activate the ground fault protection after the inverter is enabled, and consequently, the occurrence of fault F074.

**POSSIBLE SOLUTIONS:**

- Decrease the carrier frequency (P0297).
- Install an output reactor between the inverter and the motor.



**Table 6.2 (cont.)** - Solutions for the most frequent problems

Problem	Point to be Verified	Corrective Action
Motor does not operate in the field weakening region (Vector Control)	Settings	1. Decrease P0180.
Low motor speed and P0009 = P0169 or P0170 (motor operating with torque limitation), for P0202 = 4 - vector with encoder	Encoder signals are inverted or power connection is inverted	1. Check signals $\bar{A} - A, \bar{B} - B$ , refer to the incremental encoder interface manual. If signals are properly installed, exchange two of the output phases. For instance U and V.

## 6.4 INFORMATION FOR CONTACTING TECHNICAL SUPPORT



### NOTE!

For technical support and servicing, it is important to have the following information in hand:

- Inverter model;
- Serial number, manufacturing date, and hardware revision that are listed in the product nameplate (refer to item 2.4);
- Installed software version (check parameter P0023);
- Application data and inverter settings.

## 6.5 PREVENTIVE MAINTENANCE



### DANGER!

- Always turn off the mains power supply before touching any electrical component associated to the inverter.
- High voltage may still be present even after disconnecting the power supply.
- To prevent electric shock, wait at least 10 minutes after turning off the input power for the complete discharge of the power capacitors.
- Always connect the equipment frame to the protective ground (PE). Use the adequate connection terminal in the inverter.



### ATTENTION!

The electronic boards have electrostatic discharge sensitive components.

Do not touch the components or connectors directly. If needed, first touch the grounded metallic frame or wear a ground strap.

**Do not perform any withstand voltage test!  
If needed, consult WEG.**

The inverters require low maintenance when properly installed and operated . Table 6.3 presents main procedures and time intervals for preventive maintenance. Table 6.4 provides recommended periodic inspections to be performed every 6 months after inverter start-up.

*Table 6.3 - Preventive maintenance*

Maintenance		Interval	Instructions
Fan replacement		After 50.000 operating hours. <sup>(1)</sup>	Replacement procedure shown in figures 6.1 and 6.2.
Keypad battery replacement		Every 10 years.	Refer to chapter 4.
Electrolytic capacitors	If the inverter is stocked (not being used): "Reforming"	Every year from the manufacturing date printed in the inverter identification label (refer to item 2.4).	Apply power to the inverter (voltage between 200 and 230 Vac, single-phase or three-phase, 50 or 60 Hz) for at least one hour. Then, disconnect the power supply and wait at least 24 hours before using the inverter (reapply power).
	Inverter is being used: replace	Every 10 years.	Contact WEG technical support to obtain replacement procedures.

**Note:**

(1) The inverters are factory set for automatic fan control (P0352=2), which means that they will be turned on only when the heatsink temperature exceeds a reference value. Therefore, the operating hours of the fan will depend on the inverter usage conditions (motor current, output frequency, cooling air temperature, etc.).

The inverter stores the number of operating hours of the fan in parameter P0045. When this parameter reaches 50.000 operating hours, the keypad display will show alarm A177.

*Table 6.4 - Recommended periodic inspections - Every 6 months*

Component	Problem	Corrective Action
Terminals, connectors	Loose screws	Tighten
	Loose connectors	
Fans / Cooling system	Dirty fans	Cleaning
	Abnormal acoustic noise	Replace fan. Refer to figure 6.1.
	Blocked fan	Check the fan connection.
	Abnormal vibration	
	Dust in the cabinet air filter	Cleaning or replacement.
Printed circuit boards	Accumulation of dust, oil, humidity, etc.	Cleaning
	Odor	Replacement
Power module / Power connections	Accumulation of dust, oil, humidity, etc.	Cleaning
	Loose connection screws	Tighten
DC bus capacitors	Discoloration / odor / electrolyte leakage	Replacement
	Expanded or broken safety valve	
	Frame expansion	
Power resistors	Discoloration	Replacement
	Odor	
Heatsink	Dust accumulation	Cleaning
	Dirty	

### 6.5.1 Cleaning Instructions

If needed to clean the inverter, follow the guidelines below:

Ventilation system:

- ☑ Disconnect the inverter power supply and wait at least 10 minutes.
- ☑ Remove the dust from the cooling air inlet by using a soft brush or a flannel.
- ☑ Remove the dust from the heatsink fins and from the fan blades by using compressed air.

Electronic boards:

- ☑ Disconnect the inverter power supply and wait at least 10 minutes.
- ☑ Remove the dust from the electronic board by using an anti-static brush or an ion air gun (Charges Burtes Ion Gun - reference A6030-6DESCO).
- ☑ If needed, remove the boards from the inverter.
- ☑ Always wear a ground strap.



①

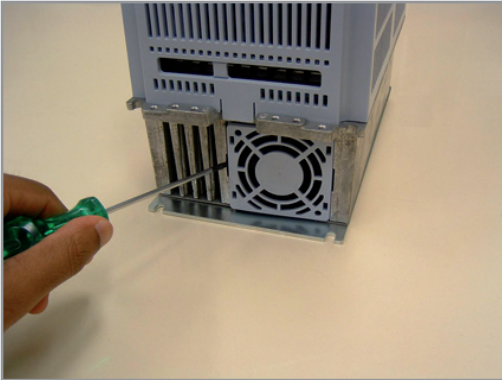

Releasing the latches of the fan cover

②

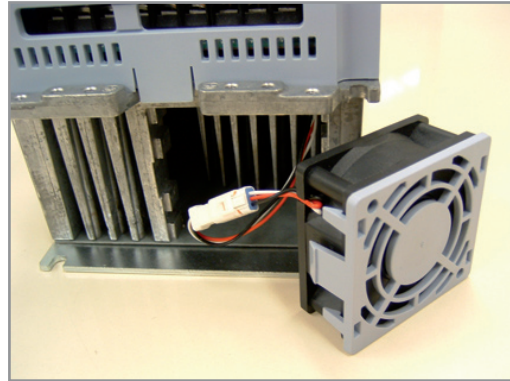

Fan removal

③

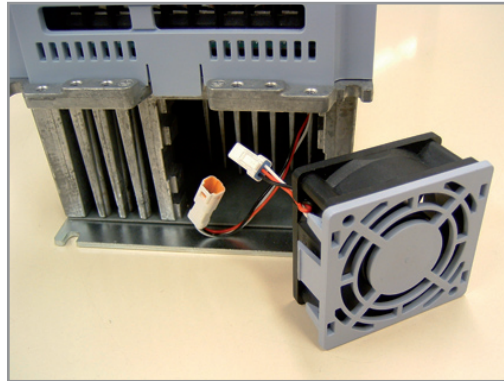

Cable disconnection

Figure 6.1 - Removing the heatsink fan

①

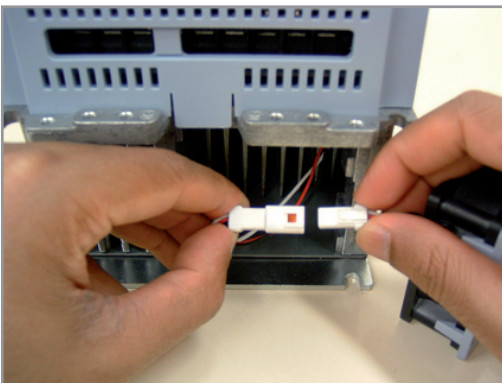

Cable connection

②

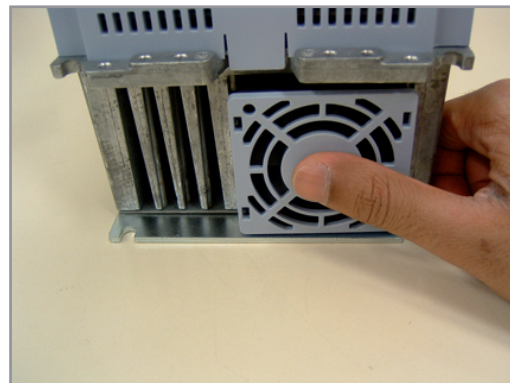

Fan fitting

Figure 6.2 - Fan installation

## OPTION KITS AND ACCESSORIES

This chapter presents:

- ☑ The option kits that can be incorporated to the inverter from the factory:
  - RFI filter;
  - Safety Stop according to EN 954-1 category 3;
  - External 24 Vdc power supply for control and keypad.
- ☑ Instructions for the proper use of the option kits.
- ☑ The accessories that can be incorporated to the inverters.



Details for the installation, operation, and programming of the accessories are described in their own manuals and were not included in this chapter.

### 7.1 OPTION KITS

Some models cannot incorporate all available option kits. Refer to table 8.1 for a detailed description of the option kits that are available for each inverter model.

The inverter codification is described in chapter 2.

#### 7.1.1 RFI Filter

Inverters with the following codification: CFW11XXXXXOFA. Refer to table 8.1 for information on availability of this option kit for each inverter model.



#### **ATTENTION!**

Do not use inverters with internal RFI filters in IT networks (ungrounded neutral or grounding provided by a high ohm value resistor) or in grounded delta networks ("delta corner earth"). These type of installations will damage the inverter filter capacitors.

The RFI filter reduces the conducted noise of the inverter to the electrical supply system in the high frequency range (>150 kHz).

The RFI filter is required for the compliance with conducted emissions limits established by the Electromagnetic Compatibility standards such as EN 61800-3 and EN 55011.

For the proper operation of the RFI filter, please follow the instructions listed in item 3.3 for the installation of the inverter, motor, cables, etc. This chapter also provides information on the compliance of these standards, such as the maximum motor cable length.

#### 7.1.2 Safety Stop According to EN 954-1 Category 3 (Pending Certification)

Inverters with the following codification: CFW11XXXXXOY.

The inverters with this option are equipped with an additional board (SRB) that contains 2 safety relays and an interconnection cable with the power circuit.

Figure 7.1 shows the location of the SRB board and the location of the connector XC25 (used for the connection of the SRB board signals) in the inverter.

The relay coils are available through the connector XC25, as presented in figure 7.1.

 **DANGER!** The activation of the Safety Stop, i.e., disconnection of the 24 Vdc power supply from the safety relay coil (XC25: 1(+) and 2(-); XC25:3(+) and 4(-)) does not guarantee the electrical safety of the motor terminals (they are not isolated from the power supply in this condition).

**Operation:**

1. The Safety Stop function is activated by disconnecting the 24 Vdc voltage from the safety relay coil (XC25: 1(+) and 2(-); XC25:3(+) and 4(-)).
2. Upon activation of the Safety Stop, the PWM pulses at the inverter output will be blocked and the motor will coast to stop.  
The inverter will not start the motor or generate a rotating magnetic field even in the event of an internal failure (pending certification).  
The keypad will display a message informing that the Safety Stop is active.
3. Apply 24 Vdc voltage to the safety relay coil (XC25: 1(+) and 2(-); XC25:3(+) and 4(-)) to get back to normal operation after activation of the Safety Stop.

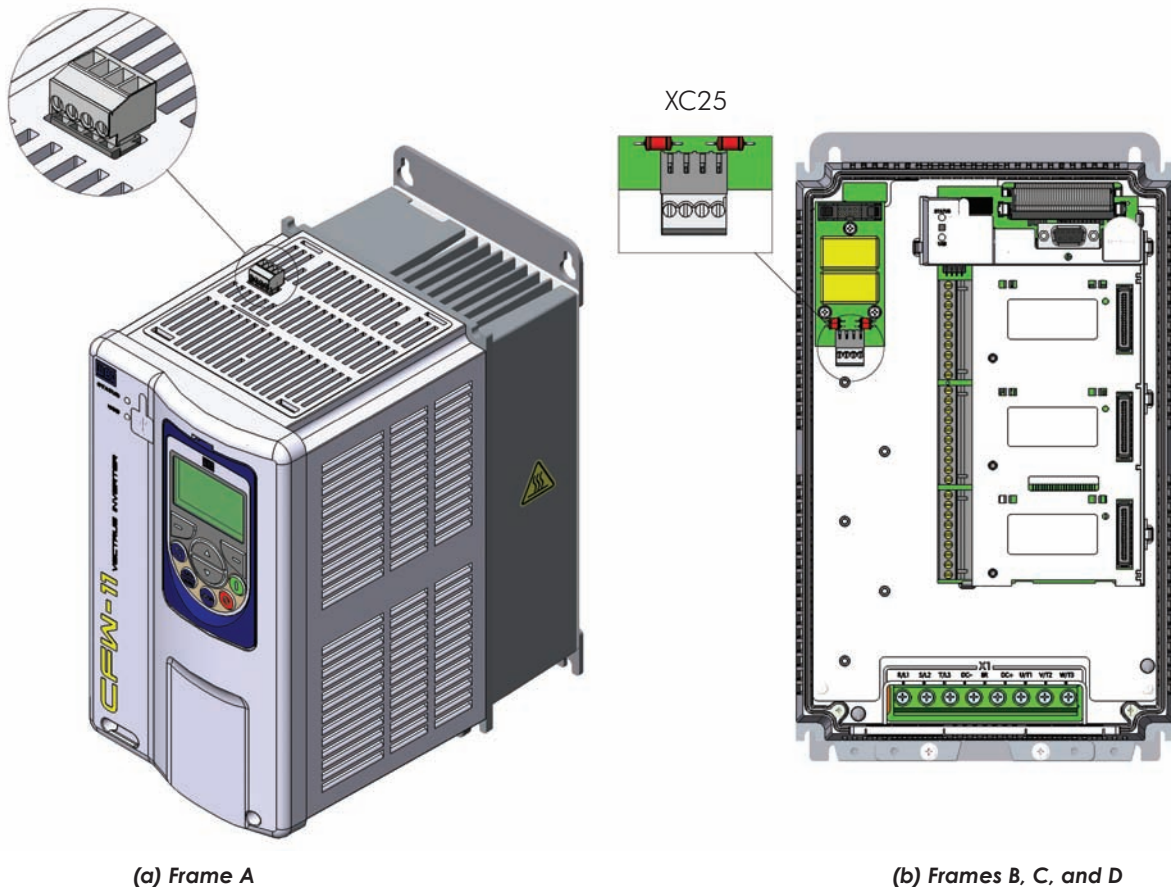

Figure 7.1 - Location of the SRB boards

Table 7.1 - XC25 connections

Connector XC25		Function	Specifications
1	R1+	Terminal 1 of relay 1 coil	Rated coil voltage: 24 V, range from 20 to 30 Vdc Coil resistance: 960 Ω ±10 % @ 20 °C (68 °F).
2	R1-	Terminal 2 of relay 1 coil	
3	R2+	Terminal 1 of relay 2 coil	Rated coil voltage: 24 V, range from 20 to 30 Vdc Coil resistance: 960 Ω ±10 % @ 20 °C (68 °F).
4	R2-	Terminal 2 of relay 2 coil	

### 7.1.3 24 Vdc External Control Power Supply

Inverters with the following codification: CFW11XXXXXXOW.

The use of this option kit is recommended with communication networks (Profibus, DeviceNet, etc.), since the control circuit and the network communication interface are kept active (with power supply and responding to the network communication commands) even in the event of main power supply interruption.

Inverters with this option have a built-in DC/DC converter with a 24 Vdc input that provides an adequate output for the control circuit. In such manner the power supply of the control circuit will be redundant, i.e., it can be provided by a 24 Vdc external power supply (connection as shown in figure 7.2) or by the standard internal switched-mode power supply of the inverter.

Observe that the inverters with the external 24 Vdc power supply option use terminals XC1:11 and 13 as the input for the external power supply and no longer as an output as in the standard inverter (figure 7.2).

In case of interruption of the external 24 Vdc power source, the digital inputs/outputs and analog outputs will have no power supply, even if the mains power is on. Therefore, it is recommended to keep the 24 Vdc power source always connected to terminals XC1:11 and 13.

The keypad displays warnings indicating the inverter status: if the 24 Vdc power source is connected, if the mains power source is connected, etc.

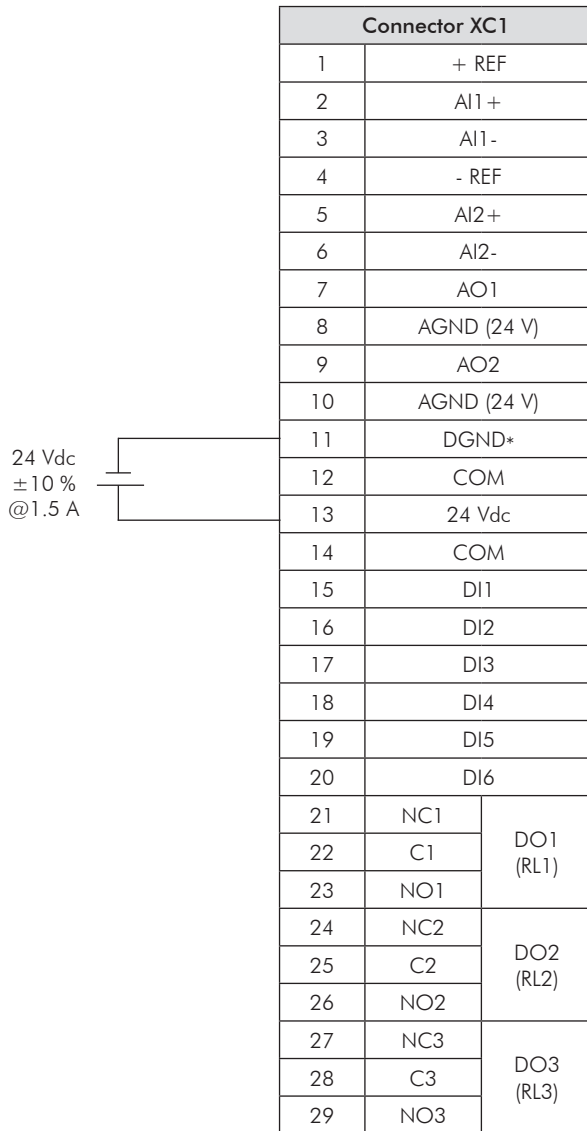

Figure 7.2 - Connection terminals and 24 Vdc external power supply rating

## 7.2 ACCESSORIES

The accessories are installed to the inverter easily and quickly using the "Plug and Play" concept. Once the accessory is connected to the slot, the control circuitry identifies the model and displays the installed accessory code in P0027 or P0028. The accessory shall be installed with the inverter power supply off.

The code and model of each available accessory is presented in the following tables. The accessories can be ordered separately and will be shipped in an individual package containing the components and the manual with detailed instructions for the product installation, operation, and programming.



### ATTENTION!

Only one module can be fitted at once in each slot (1, 2, 3, 4, or 5).

Installation in slots 1, 2, and 3:

WEG Part Number	Name	Description	Slot	Identification Parameters	
				P0027	P0028
417107424	IOA-01	IOA Module: 1 voltage/current analog input (14 bits); 2 digital inputs; 2 voltage/current analog outputs (14 bits); 2 open-collector digital outputs.	1	FD--	----
417107425	IOB-01	IOB Module: 2 isolated analog inputs (voltage/current); 2 digital inputs; 2 isolated analog outputs (voltage/current) (the programming of the outputs is identical as in the standard CFW-11); 2 open-collector digital outputs.	1	FA--	----
417107430	ENC-01	5 to 12 Vdc Incremental Encoder Module, 100 kHz, with an encoder signal repeater.	2	--C2	----
417107418	ENC-02	5 to 12 Vdc Incremental Encoder Module, 100 kHz.	2	--C2	----
417107432	RS485-01	RS-485 Serial Communication Module (Modbus).	3	----	CE--
417107433	RS232-01	RS-232C Serial Communication Module (Modbus).	3	----	CC--
417107434	RS232-02	RS-232C Serial Communication Module with DIP-switches for programming the microcontroller FLASH memory.	3	----	CC--
417107435	CAN/RS485-01	CAN and RS-485 Interface Module (CANopen / DeviceNet / Modbus).	3	----	CA--
417107436	CAN-01	CAN Interface Module (CANopen / DeviceNet).	3	----	CD--
417107431	PLC11-01	PLC Module.	1, 2, and 3	----	--xx <sup>(1)(3)</sup>

Installation in slot 4 (Anybus-CC modules):

WEG Part Number	Name	Description	Slot	Identification Parameters	
				P0027	P0028
417107450	PROFIBUSDP-05	ProfibusDP Interface Module.	4	----	--xx <sup>(2)(3)</sup>
417107451	DEVICENET-05	DeviceNet Interface Module.	4	----	--xx <sup>(2)(3)</sup>
417107458	RS232-05	RS-232 (passive) Interface Module (Modbus).	4	----	--xx <sup>(2)(3)</sup>
417107459	RS485-05	RS-485 (passive) Interface Module (Modbus).	4	----	--xx <sup>(2)(3)</sup>
417107455	ETHERNET/IP-05	Ethernet/IP Interface Module.	4	----	--xx <sup>(2)(3)</sup>

Stand-alone keypad, blank cover, and frame for remote mounted keypad:

WEG Part Number	Name	Description	Slot
417107422	HMI-01	Stand-alone keypad. <sup>(4)</sup>	HMI
417107423	RHMIF-01	Remote Keypad Frame Kit (IP56).	-
417107444	HMID-01	Blank cover for the keypad slot.	HMI

Installation in slot 5 (memory module): Incorporated in the standard product

WEG Part Number	Name	Description	Slot	Identification Parameters	
				P0027	P0028
417107401	MMF-01	FLASH memory module.	5	----	--xx <sup>(3)</sup>

Miscellaneous:

WEG Part Number	Name	Description	Slot
417107406	KN1A-01	Conduit kit for frame A (standard for option N1). <sup>(5)</sup>	-
417107409	KN1B-01	Conduit kit for frame B (standard for option N1). <sup>(5)</sup>	-
417107412	KN1C-01	Conduit kit for frame C (standard for option N1). <sup>(5)</sup>	-
417107448	KIP21D-01	IP21 kit for frame D (standard for option 21).	-
417107445	PCSA-01	Kit for power cables shielding - frame A (standard for option FA).	-
417107446	PCSB-01	Kit for power cables shielding - frame B (standard for option FA).	-
417107447	PCSC-01	Kit for power cables shielding - frame C (standard for option FA).	-
417107449	PCSD-01	Kit for power cables shielding - frame D (included in the standard product).	-
417107441	CCS-01	Kit for control cables shielding (included in the standard product).	-

Notes:

(1) Refer to the PLC Module Manual.

(2) Refer to the Anybus-CC Communication Manual.

(3) Refer to the Software Manual.

(4) Use DB-9 pin, male-to-female, straight-through cable (serial mouse extension type) for connecting the keypad to the inverter or Null-Modem standard cable. Maximum cable length: 10 m (33 ft).

Examples:

- Mouse extension cable - 1.80 m (6 ft); Manufacturer: Clone.

- Belkin pro series DB9 serial extension cable 5 m (17 ft); Manufacturer: Belkin.

- Cables Unlimited PCM195006 cable, 6 ft DB9 m/f; Manufacturer: Cables Unlimited.

(5) Refer to the section 8.4 for more details.



## TECHNICAL SPECIFICATIONS

This chapter describes the technical specifications (electrical and mechanical) of the CFW-11 inverter series.

### 8.1 POWER DATA

Power Supply:

- ☑ Voltage tolerance: -15 % to +10 %.
- ☑ Frequency: 50/60 Hz (48 Hz to 62 Hz).
- ☑ Phase imbalance:  $\leq 3$  % of the rated phase-to-phase input voltage.
- ☑ Overvoltage according to Category III (EN 61010/UL 508C).
- ☑ Transient voltage according to Category III.
- ☑ Maximum of 60 connections per hour.
- ☑ Typical efficiency:  $\geq 97$  %.
- ☑ Typical input power factor:
  - 0.94 for three-phase input (CFW11XXXXTX) at rated condition.
  - 0.70 for single-phase input at rated condition.

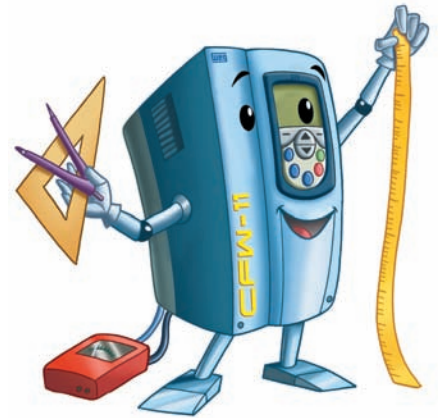



Table 8.1 - Technical specification for the CFW-11 series

Model	Frame	Number of power phases	Use with Normal Duty (ND) cycle										Use with Heavy Duty (HD) cycle										Surrounding air temperature (1)	Dynamic braking	Weight (kg/lb)	Availability of option kits that can be incorporated into the product (refer to the intelligent code in chapter 2) (8)	
			Rated output current (1) [Amps]	Overload current (2) [Amps]		Rated carrier frequency (3) [kHz]	Maximum motor (4) [HP/kW]	Rated input current [Amps]	Disipated power [W]		Rated output current (1) [Amps]	Overload current (2) [Amps]		Rated carrier frequency (3) [kHz]	Maximum motor (4) [HP/kW]	Rated input current [Amps]	Disipated power [W]		Cabinet enclosure	RFI filter	Safety stop	24 Vdc external power supply					
				1 min	3 s				Surface mounting (6)	Flange mounting (7)		1 min	3 s				Surface mounting (6)	Flange mounting (7)									
CFW11 0006B 2		1φ / 3φ	6.0	6.60	9.00	5	1.5/1.1	12.3/6.0 (5)	130	25	5.0	7.50	10.0	5	1.5/1.1	10.3/5.0 (5)	120	25	5.7/12.6	Yes (*)							
CFW11 0006S 2 O FA		1φ	6.0	6.60	9.00	5	1.5/1.1	12.3	130	25	5.0	7.50	10.0	5	1.5/1.1	10.3	120	25	5.7/12.6	Built-in							
CFW11 0007T 2		3φ	7.0	7.70	10.5	5	2/1.5	7.0	140	25	5.5	8.25	11.0	5	1.5/1.1	5.5	120	25	5.7/12.6	Yes (*)							
CFW11 0007B 2		1φ / 3φ	7.0	7.70	10.5	5	2/1.5	14.4/7.0 (5)	140	25	7.0	10.5	14.0	5	2/1.5	14.4/7.0 (5)	140	25	6.1/13.4	Yes (*)							
CFW11 0007S 2 O FA	A	1φ	7.0	7.70	10.5	5	2/1.5	14.4	140	25	7.0	10.5	14.0	5	2/1.5	14.4	140	25	6.1/13.4	Yes (*)							
CFW11 0010T 2		3φ	10	11.0	15.0	5	3/2.2	10.0	170	30	8.0	12.0	16.0	5	2/1.5	8.0	170	30	6.1/13.4	Yes (*)							
CFW11 0010S 2		1φ	10	11.0	15.0	5	3/2.2	20.5	180	30	10	15.0	20.0	5	3/2.2	20.5	140	25	6.1/13.4	Yes (*)							
CFW11 0013T 2		3φ	13	14.3	19.5	5	4/3.0	13.0	200	30	11	16.5	22.0	5	3/2.2	11.0	170	30	6.1/13.4	Yes (*)							
CFW11 0016T 2		3φ	16	17.6	24.0	5	5/3.7	16.0	230	30	13	19.5	26.0	5	4/3.0	13.0	190	30	6.3/13.9	Yes (*)							
CFW11 0024T 2		3φ	24	26.4	36.0	5	7.5/5.5	24.0	310	50	20	30.0	40.0	5	6/4.5	20.0	250	40	9.1/20	Yes (*)							
CFW11 0028T 2		3φ	28	30.8	42.0	5	10/7.5	28.0	370	60	24	36.0	48.0	5	7.5/5.5	24.0	290	40	9.1/20	Yes (*)							
CFW11 0033T 2		3φ	33.5	36.9	50.3	5	12.5/9.2	33.5	430	60	28	42.0	56.0	5	10/7.5	28.0	350	50	9.1/20	Yes (*)							
CFW11 0045T 2		3φ	45	49.5	67.5	5	15/11	45.0	590	90	36	54.0	72.0	5	12.5/9.2	36.0	450	70	15.6/34.4	Yes (*)							
CFW11 0054T 2		3φ	54	59.4	81.0	5	20/15	54.0	680	100	45	67.5	90.0	5	15/11	45.0	540	80	16.0/35.3	Yes (*)							
CFW11 0070T 2		3φ	70	77.0	105	5	25/18.5	70.0	900	140	56	84.0	112	5	20/15	56.0	680	100	17.9/39.5	Yes (*)							
CFW11 0086T 2		3φ	86	94.6	129	5	30/22	86.0	970	150	70	105	140	5	25/18.5	70.0	740	110	29.5/65.1	Yes (*)							
CFW11 0105T 2		3φ	105	116	158	5	40/30	105.0	1200	180	86	129	172	5	30/22	86.0	920	140	31.4/69.2	Yes (*)							
CFW11 0003T 4		3φ	3.6	3.96	5.40	5	2/1.5	3.6	130	25	3.6	5.40	7.20	5	2/1.5	3.6	110	25	5.7/12.6	Yes (*)							
CFW11 0005T 4		3φ	5.0	5.50	7.50	5	3/2.2	5.0	140	25	5.0	7.50	10.0	5	3/2.2	5.0	140	25	5.9/13	Yes (*)							
CFW11 0007T 4	A	3φ	7.0	7.7	10.5	5	4/3	7.0	180	30	5.5	8.25	11.0	5	3/2.2	5.5	140	25	5.9/13	Yes (*)							
CFW11 0010T 4		3φ	10	11.0	15.0	5	6/4.5	10.0	220	30	10	15.0	20.0	5	6/4.5	10.0	200	30	6.1/13.4	Yes (*)							
CFW11 0013T 4		3φ	13.5	14.9	20.3	5	7.5/5.5	13.5	280	40	11	16.5	22.0	5	6/4.5	11.0	220	30	6.3/13.9	Yes (*)							
CFW11 0017T 4		3φ	17	18.7	25.5	5	10/7.5	17.0	360	50	13.5	20.3	27.0	5	7.5/5.5	13.5	270	40	6.3/13.9	Yes (*)							
CFW11 0024T 4	B	3φ	24	26.4	36.0	5	15/11	24.0	490	70	19	28.5	38.0	5	10/7.5	19.0	360	50	9.1/20	Yes (*)							
CFW11 0031T 4		3φ	31	34.1	46.5	5	20/15	31.0	560	80	25	37.5	50.0	5	15/11	25.0	430	60	9.7/21.4	Yes (*)							
CFW11 0038T 4		3φ	38	41.8	57.0	5	25/18.5	38.0	710	110	33	49.5	66.0	5	20/15	33.0	590	90	10.4/22.9	Yes (*)							
CFW11 0045T 4	C	3φ	45	49.5	67.5	5	30/22	45.0	810	120	38	57.0	76.0	5	25/18.5	38.0	650	100	16.4/36.2	Yes (*)							
CFW11 0058T 4		3φ	58.5	64.4	87.8	5	40/30	58.5	1050	160	47	70.5	94.0	5	30/22	47.0	800	120	19.6/43.2	Yes (*)							
CFW11 0070T 4		3φ	70.5	77.6	106	5	50/37	70.5	1280	190	61	91.5	122	5	40/30	61.0	1050	160	20.5/45.2	Yes (*)							
CFW11 0088T 4	D	3φ	88	96.8	132	5	60/45	88.0	1480	220	73	110	146	5	50/37	73.0	1170	180	31.1/68.6	Yes (*)							

Notes.: 1φ=single-phase power supply, 3φ=three-phase power supply  
 (\*) That model with the optional RFI filter has only single-phase power supply input.



**Note:**

(1) Steady-state rated current in the following conditions:

- Indicated carrier frequencies. For operation with a 10 kHz carrier frequency it is necessary to derate the output current according to table 8.2.
- Surrounding air temperature: -10 °C to 50 °C (14 °F to 122 °F). The inverter is capable of operating with an maximum surrounding air temperature of 60 °C (140 °F) if an output current derating of 2 % is applied for each °C above 50 °C (122 °F).
- Relative air humidity: 5 % to 90 % non-condensing.
- Altitude: 1000 m (3,300 ft). Above 1000 m (3,300 ft) up to 4000 m (13,200 ft) the output current shall be derated by 1 % for each 100 m (330 ft) above 1000 m (3,300 ft).
- Ambient with pollution degree 2 (according to EN50178 and UL508C).

(2) Table 8.1 presents only two points of the overload curve (activation time of 1 min and 3 s). The complete information about the IGBTs overload for Normal and Heavy Duty Cycles is presented below.

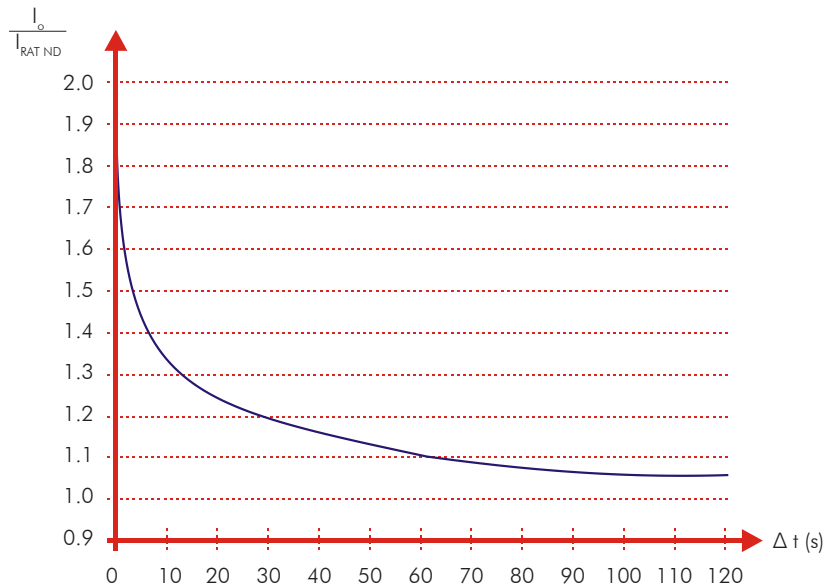

(a) IGBTs overload curve for the Normal Duty (ND) cycle

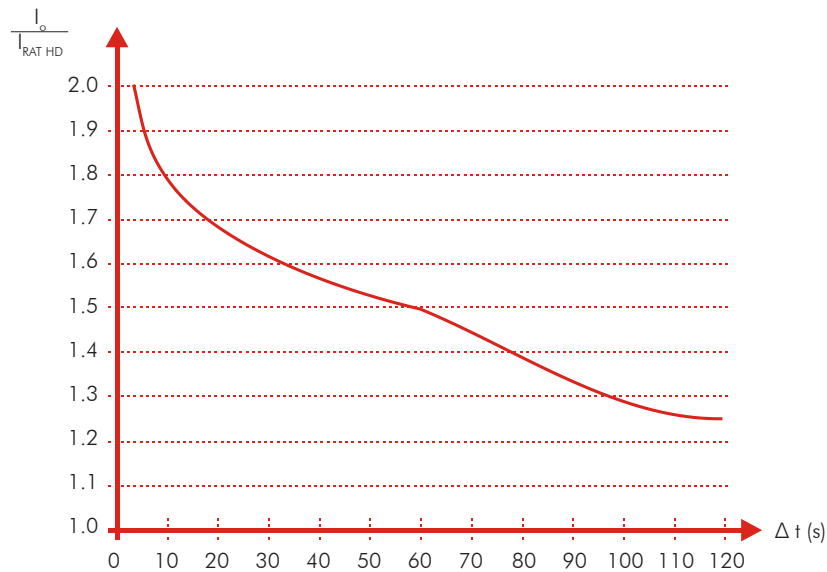

(b) IGBTs overload curve for the Heavy Duty (HD) cycle

Figure 8.1 - Overload curves for the IGBTs

Depending on the inverter usage conditions (surrounding air temperature, output frequency, possibility or not of reducing the carrier frequency, etc.), the maximum time for operation of the inverter with overload may be reduced.

**(3)** The carrier frequency may be automatically reduced to 2.5 kHz depending on the operating conditions (surrounding air temperature, output current, etc.) - if P0350=0, 1, or 4.

**(4)** The motor ratings are merely a guide for 220 V or 440 V, IV pole WEG motors. The adequate inverter sizing shall be based on the rated current of the motor used.

**(5)** Models that can operate from single-phase or three-phase power supply have their input current stated in both cases. The single-phase input current is provided first.

**(6)** The information provided about the inverter losses is valid for the rated operating condition, i.e., for rated output current and rated carrier frequency.

**(7)** The dissipated power provided for flange mounting corresponds to the total inverter losses disregarding the power module (IGBT and rectifier) losses.

**(8)** If the inverter is to be provided with this option, it should be specified in the intelligent identification code of the inverter. Exception: the RFI filter is already incorporated in models CFW110006S2OFA and CFW110007S2OFA. For further details, please refer to chapter 2.

Table 8.2 - Specification for the CFW-11 series with a carrier frequency of 10 kHz

Model	Frame	Number of power phases	Carrier frequency of 10 kHz and surrounding air temperature = 50 °C (122 °F)										Carrier frequency of 10 kHz and surrounding air temperature = 40 °C (104 °F)																		
			Use with Normal Duty (ND) cycle					Use with Heavy Duty (HD) cycle					Use with Normal Duty (ND) cycle					Use with Heavy Duty (HD) cycle													
			Rated output current (1) [A rms]	Overload current (2) [A rms]	Rated input current [A rms]	Surface mounting (6) [W]	Flange mounting (7) [W]	Rated output current (1) [A rms]	Overload current (2) [A rms]	Rated input current [A rms]	Surface mounting (6) [W]	Flange mounting (7) [W]	Rated output current (9) [A rms]	Overload current (2) [A rms]	Rated input current [A rms]	Surface mounting (6) [W]	Flange mounting (7) [W]	Rated output current (9) [A rms]	Overload current (2) [A rms]	Rated input current [A rms]	Surface mounting (6) [W]	Flange mounting (7) [W]									
CFW11 0006 B 2		1φ/3φ	5.5	6.05	8.25	1.5/1.1	11.3/5.5	140	25	25	4.6	6.90	9.20	1.5/1.1	9.4/4.6	130	25	6.00	6.60	9.00	2/1.5	12.3/6.0	150	25	5.00	5.00	10.0	1.5/1.1	10.3/5.0	130	25
CFW11 0006 S 2 O FA		1φ	5.5	6.05	8.25	1.5/1.1	11.3	140	25	4.6	6.90	9.20	1.5/1.1	9.4	130	25	6.00	6.60	9.00	2/1.5	12.3	150	25	5.00	5.00	10.0	1.5/1.1	10.3	130	25	
CFW11 0007 T 2		3φ	6.2	6.82	9.30	2/1.5	6.2	140	25	4.9	7.35	9.8	1.5/1.1	4.9	120	25	7.00	7.70	10.5	2/1.5	7.0	150	25	5.50	5.50	8.3	11.0	1.5/1.1	5.5	130	25
CFW11 0007 B 2		1φ/3φ	6.6	7.26	9.90	2/1.5	13.5/6.6	140	25	6.6	9.90	13.2	2/1.5	13.5/6.6	140	25	7.00	7.70	10.5	2/1.5	14.4/7.0	150	25	6.90	6.90	10.4	13.8	2/1.5	14.1/6.9	150	25
CFW11 0007 S 2 O FA A		1φ	7.0	7.26	9.90	2/1.5	14.35	140	25	6.6	9.90	13.2	2/1.5	13.53	140	25	7.00	7.70	10.5	2/1.5	14.35	150	25	6.90	6.90	10.4	13.8	2/1.5	14.15	150	25
CFW11 0010 S 2		1φ	8.0	8.80	12.00	2/1.5	16.4	160	25	8.0	12.00	16.0	2/1.5	16.4	160	25	9.40	10.34	14.1	3/2.2	19.3	180	30	9.40	9.40	14.1	18.8	3/2.2	19.3	180	30
CFW11 0010 T 2		3φ	8.4	9.24	12.6	2/1.5	8.4	160	25	6.7	10.1	13.4	2/1.5	6.7	140	25	10.0	11	15.0	3/2.2	10.0	180	30	8.00	8.00	12.0	16.0	2/1.5	8.0	160	25
CFW11 0013 T 2		3φ	9.8	10.8	14.7	3/2.2	9.8	180	30	8.3	12.5	16.6	2/1.5	8.3	160	30	10.7	11.8	16.1	3/2.2	10.7	190	30	9.00	9.00	13.5	18.0	3/2.2	9.0	170	30
CFW11 0016 T 2		3φ	12.8	14.1	19.2	4/3.0	12.8	210	30	10.4	15.6	20.8	3/2.2	10.4	180	30	14.6	16.1	21.9	5/3.7	14.6	240	40	12.0	12.0	18.0	24.0	4/3	12.0	200	30
CFW11 0024 T 2		3φ	23.0	25.3	34.5	7.5/5.5	23.0	320	50	19.2	28.8	38.4	6/4.5	19.2	280	40	23.8	26.2	35.7	7.5/5.5	23.8	330	50	19.9	19.9	29.9	39.8	7.5/5.5	19.9	280	40
CFW11 0028 T 2 B		3φ	23.0	25.3	34.5	7.5/5.5	23.0	330	50	19.7	29.6	39.4	6/4.5	19.7	290	40	23.8	26.2	35.7	7.5/5.5	23.8	340	50	20.4	20.4	30.6	40.8	7.5/5.5	20.4	300	50
CFW11 0033 T 2		3φ	25.2	27.7	37.8	7.5/5.5	25.2	360	50	21.0	31.5	42.0	7.5/5.5	21.0	310	50	27.5	30.3	41.3	10/7.5	27.5	390	60	23.0	23.0	34.5	46.0	7.5/5.5	23.0	330	50
CFW11 0045 T 2		3φ	36.6	40.3	54.9	12.5/9.2	36.6	540	80	29.3	44.0	58.6	10/7.5	29.3	450	50	39.3	43.2	59.0	15/11	39.3	580	90	31.4	31.4	47.1	62.8	10/7.5	31.4	470	70
CFW11 0054 T 2 C		3φ	43.2	47.5	64.8	15/11	43.2	600	90	36.0	54.0	72.0	12.5/9.2	36.0	510	50	47.0	51.7	70.5	15/11	47.0	660	100	39.3	39.3	59.0	78.6	15/11	39.3	550	80
CFW11 0070 T 2		3φ	38.5	42.4	57.8	12.5/9.2	38.5	560	80	30.8	46.2	61.6	10/7.5	30.8	460	70	42.0	46.2	63.0	15/11	42.0	610	90	33.6	33.6	50.4	67.2	12.5/9.2	33.6	500	80
CFW11 0086 T 2 D		3φ	68.8	75.7	103	25/18.5	68.8	770	120	56.0	84.0	112	20/15	56.0	640	60	75.7	83.3	114	30/22	75.7	850	130	61.6	61.6	92.4	123	20/15	61.6	700	110
CFW11 0105 T 2		3φ	84.0	92.4	126	30/22	84.0	930	140	68.8	103	138	25/18.5	68.8	770	120	96.4	106	145	30/22	96.4	1070	160	79.0	79.0	119	158	30/22	79.0	870	130
CFW11 0003 T 4		3φ	3.6	3.96	5.40	2/1.5	3.6	140	25	3.6	5.40	7.20	2/1.5	3.6	140	25	3.60	3.96	5.40	2/1.5	3.6	140	25	3.60	3.60	5.40	7.20	2/1.5	3.6	140	25
CFW11 0005 T 4		3φ	4.0	4.40	6.00	2/1.5	4.0	140	25	4.0	6.00	8.00	2/1.5	4.0	140	25	4.50	4.95	6.75	3/2.2	4.5	160	25	4.50	4.50	6.75	9.00	2/1.5	4.5	160	25
CFW11 0007 T 4 A		3φ	5.2	5.72	7.80	3/2.2	5.2	170	30	4.1	6.15	8.20	2/1.5	4.1	150	25	5.80	6.38	8.70	3/2.2	5.8	180	30	4.60	4.60	6.90	9.20	2/1.5	4.6	160	25
CFW11 0010 T 4		3φ	9.2	10.1	13.8	5/3.7	9.2	250	40	9.2	13.8	18.4	5/3.7	9.2	250	40	10.0	11.0	15.0	6/4.5	10.0	260	40	10.0	10.0	15.0	20.0	6/4.5	10.0	260	40
CFW11 0013 T 4		3φ	11.5	12.7	17.3	7.5/5.5	11.5	290	40	9.5	14.3	19.0	6/4.5	9.5	250	40	12.7	14.0	19.1	7.5/5.5	12.7	320	50	10.4	10.4	15.6	20.8	6/4.5	10.4	270	40
CFW11 0017 T 4		3φ	11.9	13.1	17.9	7.5/5.5	11.9	320	50	9.5	14.3	19.0	6/4.5	9.5	270	40	13.1	14.4	19.7	7.5/5.5	13.1	350	50	10.4	10.4	15.6	20.8	6/4.5	10.4	290	40
CFW11 0024 T 4 B		3φ	14.4	15.8	21.6	7.5/5.5	14.4	390	60	11.5	17.3	23.0	7.5/5.5	11.5	330	50	15.8	17.4	23.7	10/7.5	15.8	420	60	12.5	12.5	18.8	25.0	7.5/5.5	12.5	350	50
CFW11 0031 T 4		3φ	23.6	26.0	35.4	15/11	23.6	560	80	19.0	28.5	38.0	10/7.5	19.0	470	70	28.3	31.1	42.5	15/11	28.3	650	100	24.0	24.0	36.0	48.0	15/11	24.0	560	80
CFW11 0038 T 4		3φ	23.6	26.0	35.4	15/11	23.6	620	90	20.5	30.8	41.0	12.5/9.2	20.5	560	80	28.5	31.4	42.8	15/11	28.5	710	110	24.8	24.8	37.2	49.6	15/11	24.8	640	100
CFW11 0045 T 4 C		3φ	30.6	33.7	45.9	20/15	30.6	730	110	25.9	38.9	51.8	15/11	25.9	650	100	33.8	37.2	50.7	20/15	33.8	790	120	28.5	28.5	42.8	57.0	15/11	28.5	700	110
CFW11 0058 T 4		3φ	35.1	38.6	52.7	20/15	35.1	820	120	28.2	42.3	56.4	15/11	28.2	700	110	41.0	45.1	61.5	25/18.5	41.0	930	140	32.9	32.9	49.4	65.8	20/15	32.9	780	120
CFW11 0070 T 4 D		3φ	38.8	42.7	58.2	25/18.5	38.8	910	140	33.6	50.4	67.2	20/15	33.6	810	120	42.3	46.5	63.5	25/18.5	42.3	970	150	36.6	36.6	54.9	73.2	20/15	36.6	870	130
CFW11 0088 T 4		3φ	48.4	53.2	72.6	30/22	48.4	1080	160	40.2	60.3	80.4	25/18.5	40.2	940	140	52.6	57.9	78.9	30/22	52.6	1160	170	43.7	43.7	65.6	87.4	30/22	43.7	1000	150

Notes:

- 1φ=single-phase power supply, 3φ=three-phase power supply;
- Verify notes for table 8.1.

(9)

- Surrounding air temperature: -10 to 40 °C (-14 to 104 °F);
- Relative air humidity: 5 % to 90 % non-condensing;
- Altitude: 1000 m (3,300 ft). Above 1000 m (3,300 ft) up to 4000 m (13,200 ft) the output current shall be derated by 1 % for each 100 m (330 ft) above 1000 m (3,300 ft).
- Ambient with pollution degree 2 (according to EN 50178 and UL 508C).

## 8.2 ELECTRICAL / GENERAL SPECIFICATIONS

CONTROL	METHOD	<ul style="list-style-type: none"> <li><input checked="" type="checkbox"/> Voltage source</li> <li><input checked="" type="checkbox"/> Type of control:                             <ul style="list-style-type: none"> <li>- V/f (Scalar);</li> <li>- VVW: Voltage Vector Control;</li> <li>- Vector control with encoder;</li> <li>- Sensorless vector control (without encoder).</li> </ul> </li> <li><input checked="" type="checkbox"/> PWM SVM (Space Vector Modulation);</li> <li><input checked="" type="checkbox"/> Full digital (software) current, flux, and speed regulators. Execution rate:                             <ul style="list-style-type: none"> <li>- current regulators: 0.2 ms (5 kHz)</li> <li>- flux regulator: 0.4 ms (2,5 kHz)</li> <li>- speed regulator / speed measurement: 1.2 ms</li> </ul> </li> </ul>
	OUTPUT FREQUENCY	<ul style="list-style-type: none"> <li><input checked="" type="checkbox"/> 0 to 3.4 x rated motor frequency (P0403). The rated frequency is programmable from 0 Hz to 300 Hz in the scalar mode and from 30 Hz to 120 Hz in the vector mode.</li> </ul>
PERFORMANCE	SPEED CONTROL	<p><u>V/f (Scalar):</u></p> <ul style="list-style-type: none"> <li><input checked="" type="checkbox"/> Regulation (with slip compensation): 1 % of the rated speed.</li> <li><input checked="" type="checkbox"/> Speed variation range: 1:20.</li> </ul> <p><u>VVW:</u></p> <ul style="list-style-type: none"> <li><input checked="" type="checkbox"/> Regulation: 1 % of the rated speed.</li> <li><input checked="" type="checkbox"/> Speed variation range: 1:30.</li> </ul> <p><u>Sensorless:</u></p> <ul style="list-style-type: none"> <li><input checked="" type="checkbox"/> Regulation: 0.5 % of the rated speed.</li> <li><input checked="" type="checkbox"/> Speed variation range: 1:100.</li> </ul> <p><u>Vector with Encoder:</u></p> <ul style="list-style-type: none"> <li><input checked="" type="checkbox"/> Regulation:                             <ul style="list-style-type: none"> <li>±0.01 % of the rated speed with a 14-bits analog input (IOA);</li> <li>±0.01 % of the rated speed with a digital reference (Keypad, Serial, Fieldbus, Electronic Potentiometer, Multispeed);</li> <li>±0.05 % of the rated speed with a 12-bits analog input (CC11).</li> </ul> </li> </ul>
	TORQUE CONTROL	<ul style="list-style-type: none"> <li><input checked="" type="checkbox"/> Range: 10 to 180 %, regulation: ±5 % of the rated torque (with encoder);</li> <li><input checked="" type="checkbox"/> Range: 20 to 180 %, regulation: ±10 % of the rated torque (sensorless above 3 Hz).</li> </ul>
INPUTS (CC11 board)	ANALOG	<ul style="list-style-type: none"> <li><input checked="" type="checkbox"/> 2 isolated differential inputs; resolution of AI1: 12 bits, resolution of AI2: 11bits + signal, (0 to 10) V, (0 to 20) mA or (4 to 20) mA, Impedance: 400 kΩ for (0 to 10) V, 500 Ω for (0 to 20) mA or (4 to 20) mA, programmable functions.</li> </ul>
	DIGITAL	<ul style="list-style-type: none"> <li><input checked="" type="checkbox"/> 6 isolated digital inputs, 24 Vdc, programmable functions.</li> </ul>
OUTPUTS (CC11 board)	ANALOG	<ul style="list-style-type: none"> <li><input checked="" type="checkbox"/> 2 isolated analog outputs, (0 to 10) V, <math>R_L \geq 10 \text{ k}\Omega</math> (maximum load), 0 to 20 mA / 4 to 20 mA (<math>R_L \leq 500 \Omega</math>) resolution: 11 bits, programmable functions.</li> </ul>
	RELAY	<ul style="list-style-type: none"> <li><input checked="" type="checkbox"/> 3 relay outputs with NO/NC contacts, 240 Vac, 1 A, programmable functions.</li> </ul>
SAFETY	PROTECTION	<ul style="list-style-type: none"> <li><input checked="" type="checkbox"/> Output overcurrent/short-circuit;</li> <li><input checked="" type="checkbox"/> Under / Overvoltage;</li> <li><input checked="" type="checkbox"/> Phase loss;</li> <li><input checked="" type="checkbox"/> Overtemperature;</li> <li><input checked="" type="checkbox"/> Braking resistor overload;</li> <li><input checked="" type="checkbox"/> IGBTs overload;</li> <li><input checked="" type="checkbox"/> Motor overload;</li> <li><input checked="" type="checkbox"/> External fault / alarm;</li> <li><input checked="" type="checkbox"/> CPU or memory fault;</li> <li><input checked="" type="checkbox"/> Output phase-ground short-circuit.</li> </ul>
INTEGRAL KEYPAD (HMI)	STANDARD KEYPAD	<ul style="list-style-type: none"> <li><input checked="" type="checkbox"/> 9 operator keys: Start/Stop, Up Arrow, Down Arrow, Direction of Rotation, Jog, Local/Remote, Right Soft Key and Left Soft Key;</li> <li><input checked="" type="checkbox"/> Graphical LCD display;</li> <li><input checked="" type="checkbox"/> View/edition of parameters;</li> <li><input checked="" type="checkbox"/> Indication accuracy:                             <ul style="list-style-type: none"> <li>- current: 5 % of the rated current;</li> <li>- speed resolution: 1 rpm;</li> </ul> </li> <li><input checked="" type="checkbox"/> Possibility of remote mounting.</li> </ul>

## 8.2 ELECTRICAL / GENERAL SPECIFICATIONS (cont.)

ENCLOSURE	IP20	<input checked="" type="checkbox"/> Models of frames A, B, and C without the top cover and conduit kit.
	NEMA1/IP20	<input checked="" type="checkbox"/> Models of frame D without the IP21 kit.
	IP21	<input checked="" type="checkbox"/> Models of frames A, B, and C with the top cover.
	NEMA1/IP21	<input checked="" type="checkbox"/> Models of frames A, B, and C with the top cover and conduit kit; <input checked="" type="checkbox"/> Models of frame D with the IP21 kit.
PC CONNECTION FOR INVERTER PROGRAMMING	USB CONNECTOR	<input checked="" type="checkbox"/> USB standard Rev. 2.0 (basic speed); <input checked="" type="checkbox"/> Type B (device) USB plug; <input checked="" type="checkbox"/> Interconnection cable: standard host/device shielded USB cable.

### 8.2.1 Codes and Standards

SAFETY STANDARDS	<input checked="" type="checkbox"/> UL 508C - Power conversion equipment. <input checked="" type="checkbox"/> UL 840 - Insulation coordination including clearances and creepage distances for electrical equipment. <input checked="" type="checkbox"/> EN61800-5-1 - Safety requirements electrical, thermal and energy. <input checked="" type="checkbox"/> EN 50178 - Electronic equipment for use in power installations. <input checked="" type="checkbox"/> EN 60204-1 - Safety of machinery. Electrical equipment of machines. Part 1: General requirements. <p><b>Note:</b> The final assembler of the machine is responsible for installing an safety stop device and a supply disconnecting device.</p> <input checked="" type="checkbox"/> EN 60146 (IEC 146) - Semiconductor converters. <input checked="" type="checkbox"/> EN 61800-2 - Adjustable speed electrical power drive systems - Part 2: General requirements - Rating specifications for low voltage adjustable frequency AC power drive systems.
ELECTROMAGNETIC COMPATIBILITY (EMC)	<input checked="" type="checkbox"/> EN 61800-3 - Adjustable speed electrical power drive systems - Part 3: EMC product standard including specific test methods. <input checked="" type="checkbox"/> EN 55011 - Limits and methods of measurement of radio disturbance characteristics of industrial, scientific and medical (ISM) radio-frequency equipment. <input checked="" type="checkbox"/> CISPR 11 - Industrial, scientific and medical (ISM) radio-frequency equipment - Electromagnetic disturbance characteristics - Limits and methods of measurement. <input checked="" type="checkbox"/> EN 61000-4-2 - Electromagnetic compatibility (EMC) - Part 4: Testing and measurement techniques - Section 2: Electrostatic discharge immunity test. <input checked="" type="checkbox"/> EN 61000-4-3 - Electromagnetic compatibility (EMC) - Part 4: Testing and measurement techniques - Section 3: Radiated, radio-frequency, electromagnetic field immunity test. <input checked="" type="checkbox"/> EN 61000-4-4 - Electromagnetic compatibility (EMC) - Part 4: Testing and measurement techniques - Section 4: Electrical fast transient/burst immunity test. <input checked="" type="checkbox"/> EN 61000-4-5 - Electromagnetic compatibility (EMC) - Part 4: Testing and measurement techniques - Section 5: Surge immunity test. <input checked="" type="checkbox"/> EN 61000-4-6 - Electromagnetic compatibility (EMC)- Part 4: Testing and measurement techniques - Section 6: Immunity to conducted disturbances, induced by radio-frequency fields.
MECHANICAL STANDARDS	<input checked="" type="checkbox"/> EN 60529 - Degrees of protection provided by enclosures (IP code). <input checked="" type="checkbox"/> UL 50 - Enclosures for electrical equipment.

### 8.3 MECHANICAL DATA

#### Frame A

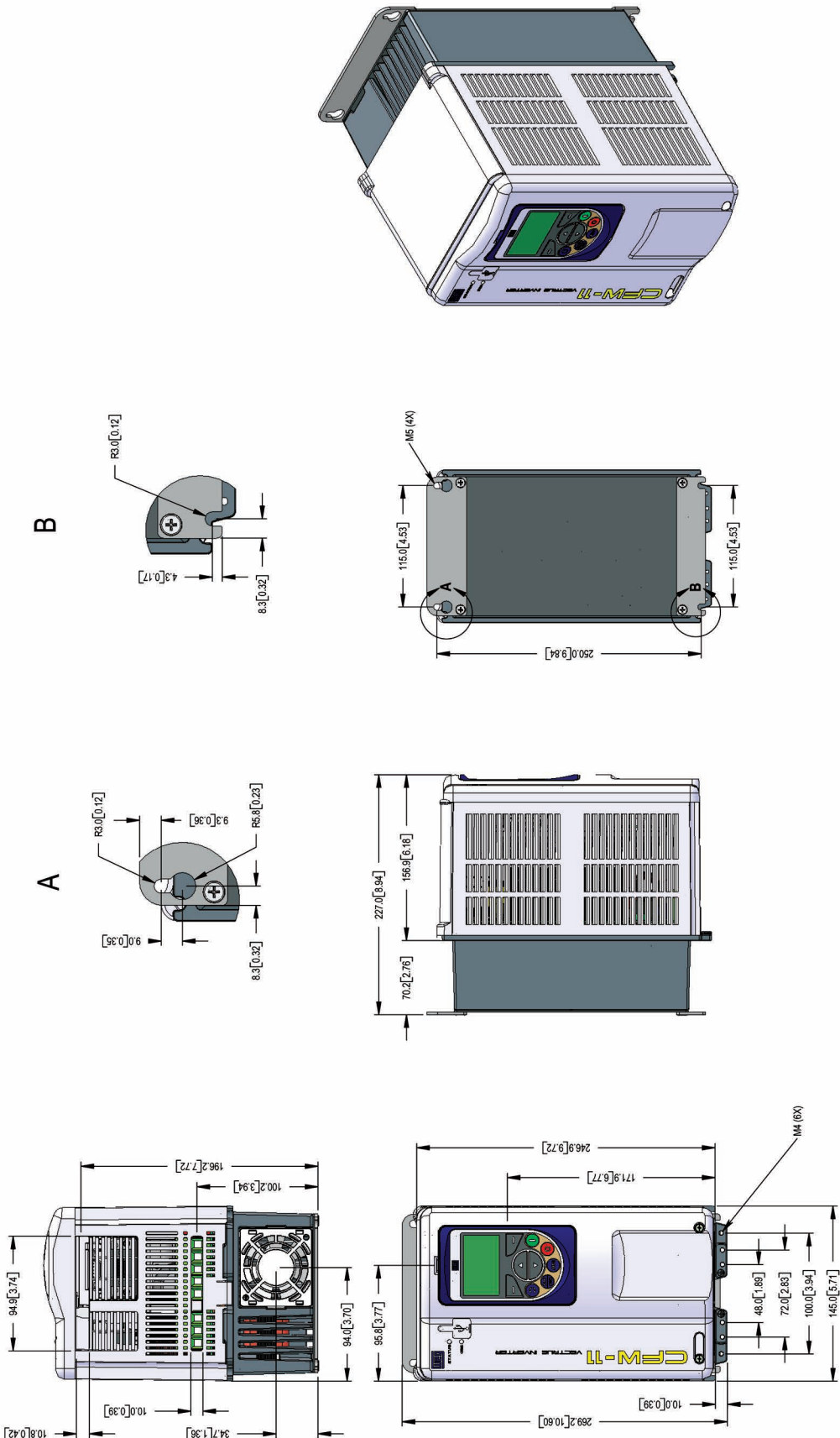

\* Dimensions in mm [in]

Figure 8.2 - Inverter dimensions - frame A

Frame B

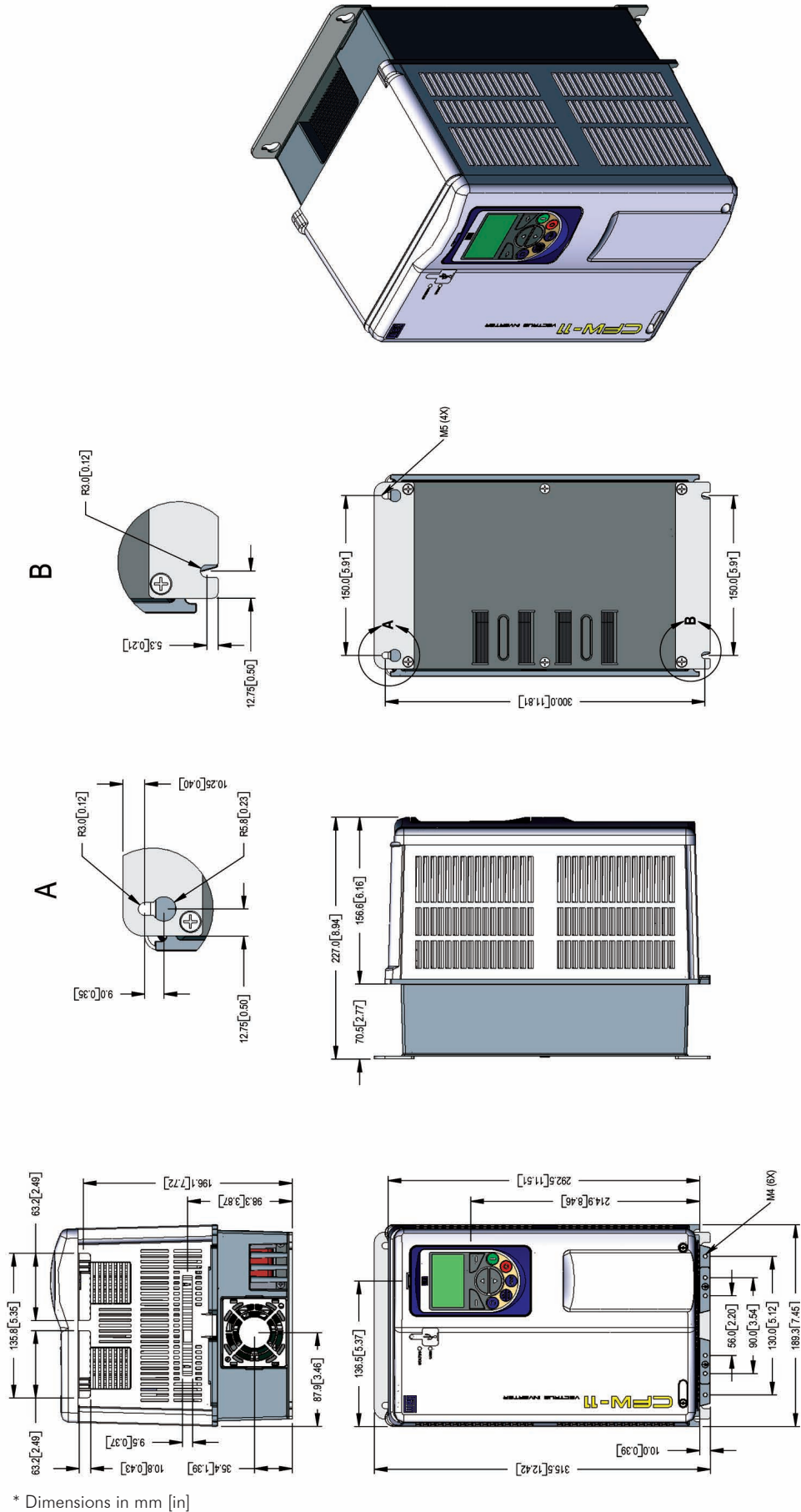

\* Dimensions in mm [in]

Figure 8.3 - Inverter dimensions - frame B



Frame C

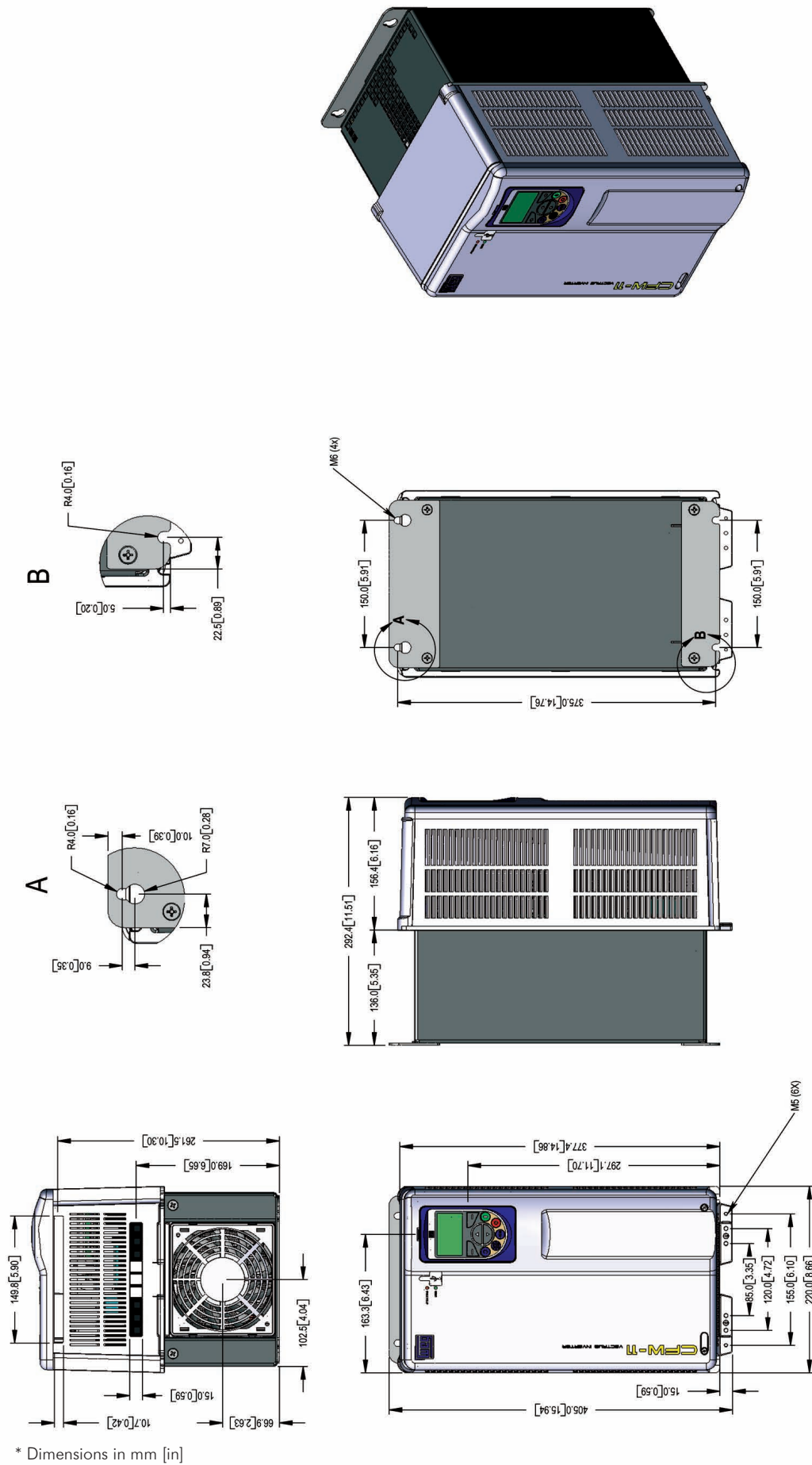

\* Dimensions in mm [in]

Figure 8.4 - Inverter dimensions - frame C



### 8.4 CONDUIT KIT

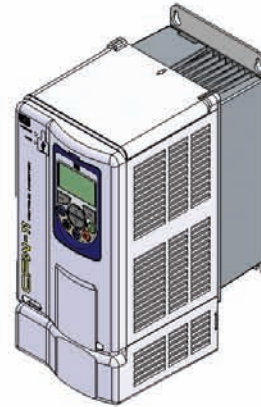
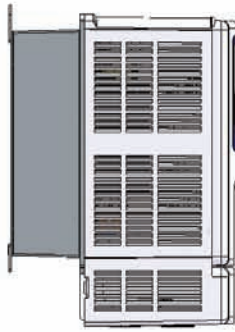
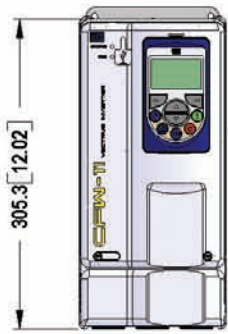

- Weight of the conduit kit for frame size A: 0.8/1.8 kg/lb

(a) Frame A with the conduit kit KN1A-01

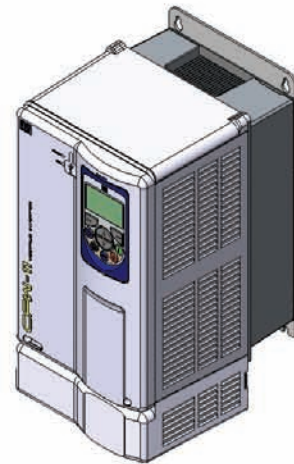
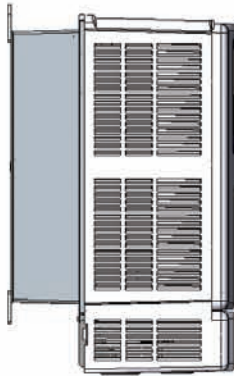
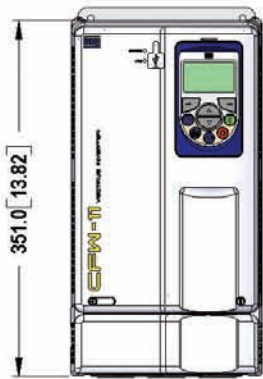

- Weight of the conduit kit for frame size B: 0.9/2.0 kg/lb

(b) Frame B with the conduit kit KN1B-01

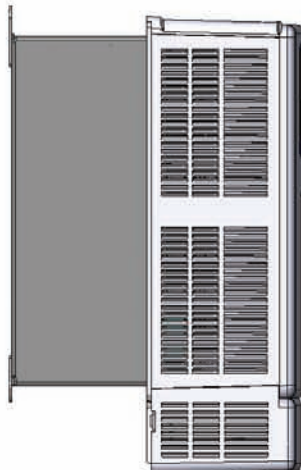
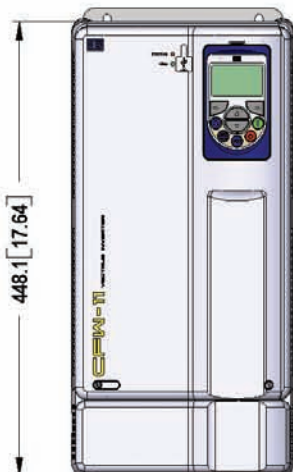

- Weight of the conduit kit for frame size C: 0.9/2.0 kg/lb

(c) Frame C with the conduit kit KN1C-01